



Plastic  
**CELEBRATING**  
1972 ~ 2022  
**50 YEARS**  
**OF TRADING**

**2022**

~ DIGITAL ~

**PRICE LIST**

**VERSION 2.1**

*Summer Issue*

CONFIDENTIAL  
PLASTICA TRADING COMPANY LTD  
TELEPHONE (0424) 436887



PRICE LIST  
EFFECTIVE  
MARCH 1981



PRICE LIST 2012

www.plasticapools.net



PRICE LIST



2006



www.plasticapools.com

Plastica Products Pool Products Plastica Pool Products Plastica Pool Products Plastica Pool Products



PLASTICA LIMITED  
17 VYHOUSE LANE, HASTINGS, EAST SUSSEX TN35 4NF

TELEPHONE (0424) 436887

TELEX NO: 95487 PLASTI G  
FAX: 0424 434221

PRICE LIST  
EFFECTIVE: FEBRUARY 2008



Plastica Products Pool Products Plastica Pool Products Plastica Pool Products Plastica Pool Products



2004 PRICE LIST

www.plasticapools.com



Plastica  
1994



Plastica  
2018  
PRICE LIST

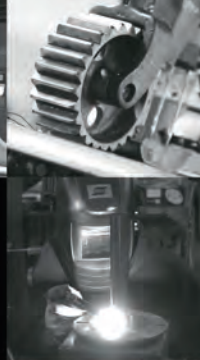

PRICE LIST 2013

www.plasticapools.net



2008  
PRICE LIST



Plastica  
2019  
PRICE LIST

45 YEARS  
Plastica



Price List 2017

www.plasticapools.net



2005  
PRICE LIST



www.plasticapools.com



www.plasticapools.com

The UK's Leading Independent Swimming Pool Manufacturer and Distributor

Plastica Products Pool Products Plastica Pool Products Plastica Pool Products Plastica Pool Products



PLASTICA LIMITED  
17 VYHOUSE LANE, HASTINGS, EAST SUSSEX TN35 4NF

TELEPHONE (0424) 436887

TELEX NO: 95487 PLASTI G  
FAX: 0424 434221

PRICE LIST  
EFFECTIVE: FEBRUARY 2008



Plastica Products Pool Products Plastica Pool Products Plastica Pool Products Plastica Pool Products



2002 PRICE LIST

www.plasticapools.com



2007  
PRICE

www.plasticapools.com



The UK's Leading Independent Swimming Pool Manufacturer and Distributor

Plastica Products Pool Products Plastica Pool Products Plastica Pool Products Plastica Pool Products



PLASTICA LIMITED  
17 VYHOUSE LANE INDUSTRIAL ESTATE,  
HASTINGS, EAST SUSSEX TN35 4NF

TELEPHONE (0424) 436887

TELEX No: 95487 PLASTI G

FAX: 0424 434221

PRICE LIST  
EFFECTIVE: MARCH 1991



Plastica Products Pool Products Plastica Pool Products Plastica Pool Products Plastica Pool Products



**Welcome to our 2022 Catalogue and Plastica's 50th year of serving the swimming pool industry as an independent business within the wet leisure industry. Since we were established in 1972, Plastica have been successfully producing quality, bespoke swimming pool products for the UK and worldwide market.**

Due to the current ever-changing economic climate, we have made some changes to our **2022 Price List**. You will notice that it is now called a catalogue and has no prices included. We have all been affected by the ever-increasing costs due to the worldwide supply, demand issues and no doubt a knock-on effect of the pandemic, Brexit and inflation. Therefore, to keep our customers up-to-date with current costs we will be publishing separate Price Lists which will be amended as necessary through the year. We hope we can decrease some prices if raw material and freight rates stabilise. The Price Lists will be available this year as printed copies and in a pdf format. From 2023, we will only distribute them electronically in a pdf format, to do our bit for the environment.

To get back to the positives, over the last 21 months Plastica have seen a huge increase in demand and we hope this has also been reflected in your businesses as well. Two of the main areas of the company that flourished were our Wooden Pools and Water Treatment departments.

As a result, Plastica invested in a new unit to expand its growing **Water Treatment department**. The company managed to keep manufacturing, while adhering to social distancing rules throughout lockdown as orders escalated.

A decision was made to expand into a nearby 5,000 square foot unit which has enabled more storage space and room for an automated filling and capping machine.

This has been successfully run by a team of experienced Water Treatment staff and the extra space will increase Plastica's manufacturing capacity.

Plastica's **Above Ground wooden pools** continue to be a popular choice with end-users. To keep up with demand, Plastica took the decision to move their Liners department to a unit close to the new Water Treatment building, allowing more space for storage of timber products. In addition, Plastica installed a new Optimised Automatic Cross Cutting machine to increase productivity. Plastica's Timber Products Manager says, *"This is good news for the department, the new cross cutter will improve accuracy and increase workflow and the additional space will help with packing our wooden pool kits"*.

**Manufacturing during such unprecedented times has been demanding but Plastica has risen to the challenge, as they have throughout their 50 years of trading.**

The new rectangular **NAZCA wooden pools** are designed for a quick build time and their simple lines make the most of available outdoor space. Have a look at the specifications in the Above Ground section page 169 onwards. This year Plastica have launched the new NAZCA Pool Safety Cover, details are also in this catalogue on page 194.

This year Plastica have secured exclusivity with a new range of four **Mediterranean inspired liner patterns**. The material used for Plastica's liners is covered by a 5-year pro-rata guarantee. Plus, our domestic liners also come with an embossed serial number for efficient quoting and production when ordering a replacement. Plastica also caters to the commercial market with their **Extreme** reinforced on-site lining which is ideal for new pools, refurbs on leaking concrete or tiled pools and a tough and durable solution for the commercial sector.

Manufacturing during such unprecedented times has been demanding but Plastica has risen to the challenge, as they have throughout their 50 years of trading. Lead times on production continue to be fluid to accommodate the current disruption of a turbulent global market and monitored weekly by our Production team to keep customers in the loop. You can read how Plastica started 50 years ago this March on pages 264-265, surviving the Oil Crisis and many other economic downturns. Production may have had to slowed down its pace but it hasn't stopped Plastica's manufacturing progress and growth.

We look forward with a positive mindset and wish you all a prosperous but most of all healthy year ahead!

*The Plastica Team*

## STANDARD CARRIAGE CHARGES (to UK mainland only)

Free delivery to the account address with an order value in excess of **£635** exc. VAT on an Economy Service or **£775** exc. VAT on an Express Service.

	Weight	Economy	Express	AM	Before 10.30am	Saturday
Standard	Under 1kg	£7.50	£9.25	£15.00	£26.00	£24.00
	Under 2kg	£9.75	£11.50	£19.00	£30.00	£28.00
	Under 10kg	£14.00	£18.50	£24.00	£35.00	£32.00
	Under 20kg	£17.25	£23.00	£30.00	£42.00	£36.00
	Under 30kg	£20.75	£27.75	£35.00	£48.00	£40.00
	30-300kg	£20.75 + 13p per additional kg	£27.75 + 17p per additional kg	£35 + 17p per additional kg	£48 + 25p per additional kg	£40 + 31p per additional kg
	Over 250kg	£50.00	£66.00	£75.00	£100.00	£120.00
	Over 500kg	£65.00	£82.00	£97.50	£125.00	£150.00
	1000kg	£80.00	£100.00	£115.00	£150.00	£180.00
	Each additional 250kg	£20.00	£25.00	£28.75	£37.50	£45.00

For delivery to postcodes AB, DD, IV, KW PA20+, PH, the Isle of Wight and Northern Ireland please refer to [www.plasticapools.net/delivery-charges](http://www.plasticapools.net/delivery-charges).

## EXCLUSIONS

The following items will always incur a delivery charge but will be included in the total order value calculation towards free delivery for the rest of the order: Silica Sand and Glass Media, Salt, Solar Covers 10sqm and over, reel systems, foam, felt, water logs, liners 40sqm and over, lengths over 3m, sand filters, heat pumps, coping stones, special order items, counter current units, safety covers, sodium hypochlorite, hydrochloric acid, IQUE Spas, bulky bags, hydrogen peroxide, and Above Ground Pools.

### BULKY

**Bulky Items** - Solar Covers 10sqm and over, Domestic Reel Systems, Foam, Felt and Water Logs

	Economy	Express	AM	Before 10:30am	Saturday
First Item	£24.00	£30.00	£42.00	£65.00	£80.00
Each Additional Item	£15.00	£19.00	£26.00	£34.00	£48.00

### HEAVY

**Liners** - Liners 40sqm and over

	Economy	Express	AM	Before 10:30am	Saturday
Each Item	£34.00	£42.00	£50.00	£60.00	£75.00

### LONG

**Lengths** - Between 3m and 5.8m (over this length requires a bespoke quote for delivery. Solar covers with a commercial leading edge and heat retention covers. Surcharge may be applied to spa covers over 15sqm)

	Economy	Express	AM	Before 10:30am	Saturday
First Item	£34.00	£44.00	£46.00	£60.00	£75.00
Each Additional Item	£20.00	£25.00	£25.00	£38.00	£50.00

### PALLET

**Pallet Rates**

	Economy	Express	AM or PM	Booked In	Saturday
Quarter Pallet	£50.00	£66.00	£75.00	£100.00	£120.00
Half Pallet	£65.00	£82.00	£95.00	£125.00	£150.00
Pallet	£80.00	£100.00	£115.00	£150.00	£180.00

All Standard Delivery Charges include postage, packing and insurance handling.  
Note: Hazardous Water Treatment orders cannot be guaranteed for Next Day delivery.  
Example: Order weight 100kg = £27.75 + 17p x 70kg = £39.65

### PLEASE NOTE:

- Please supply mobile number or email address. Re-delivery charges may be applicable if contact details haven't been supplied
- Express Delivery is normally next working day but not guaranteed.
- Economy Delivery takes up to 3 working days.
- Surcharges apply for Isle of Wight, Northern Ireland and Scottish Highlands.  
For all other destinations please contact Customer Services for a quote.
- All orders are treated as separate transactions and carriage charges applied accordingly.
- The deadline for processing orders for same day dispatch is Monday - Thursday 2.30pm and 1pm Friday (11am for Hazardous Goods). Orders placed after these times will be processed on the next working day.













**Whilst Plastica Ltd and our carriers make every effort to ensure that all goods are delivered on time and together, we will not be held responsible for delays due to unforeseen circumstances.**

**We recommend that delivery is secured before your workforce is sent to site to prevent wasted time and incurred costs.**

**13,000 SQM** *Factory*



## PRICE LIST SYMBOLS EXPLAINED

	<b>ORDER ON REQUEST</b>	Non-stock product purchased at customers request may be delivered direct from supplier. Following terms will apply in addition to standard conditions of sale: goods cannot be returned, carriage will be charged at cost, you may be asked to sign a special order form for these goods.
	<b>MADE TO ORDER</b>	Item not held as standard Plastica stock. Made to specific customer requirements. Cannot be returned.
	<b>NON RETURN</b>	Products indicated by this symbol are non-returnable and credit(s) will not be authorised unless goods are found to be faulty or as a result of a Plastica error.
	<b>EXTRA CARRIAGE</b>	This item incurs extra carriage.
	<b>FIXED CARRIAGE</b>	Items which are subject to additional carriage charges. Please see map on page 4 for charges.
	<b>HAZARDOUS</b>	This item is subject to transport regulations – such as water treatment products and paint.
	<b>HEAVY ITEM</b>	This item may require multiple persons or machinery to assist in off-loading or movement to site.
	<b>BULKY ITEM</b>	This item may be awkward to handle and require multiple persons or machinery to assist in off-loading.
	<b>PALLET DELIVERY</b>	Items to be delivered on a pallet, this may be a quarter, half or full pallet depending on size and quantity ordered.
	<b>LONG ITEM</b>	This item is long and provision should be made for adequate storage space on delivery.
	<b>INSTALLATION AVAILABLE</b>	The item is available for installation.
 	<b>WARRANTIES</b>	5 or 10 year pro-rata Wooden Pool warranties applied. Terms and conditions apply - see page 259.

The survey prices are priced per survey and the prices are based on the surveyor being able to do the survey in one day. If for any reason they have to stay overnight or additional work is required then the price could change.

## SURVEY CHARGES

Surveys are available for Domestic Liners, Airdomes, Winter Debris, Covers and Supercovers. Contact our Production Office for details.

All other postcodes and any non-mainland sites are to be quoted for a survey.

**Note:** Pools being surveyed for Domestic Liners must be empty with the old liner removed. If pool is not ready, extra costs may be incurred. Prices shown are priced per individual site. Any special requirements or time restraints may incur additional costs.

£270.00 Postal Area:	TN BN RH
£335.00 Postal Area:	PO GU SL WD EN SS KT ME CT
£380.00 Postal Area:	SO RG HP AL LU SG CM LONDON
£425.00 Postal Area:	BH SP OX MK CB IP CO
£470.00 Postal Area:	DT BA BS SN GL NN PE NR
£540.00 Postal Area:	TA NP HR WR B CV LE
POA Postal Area:	TQ EX CF DY WV WS DE NG
	PL LD SY TF ST CH CW SK S LN
	TR SA LL L WA WN FY PR BB BL M OL HD
	HX BD WF LS HG YO DN HU

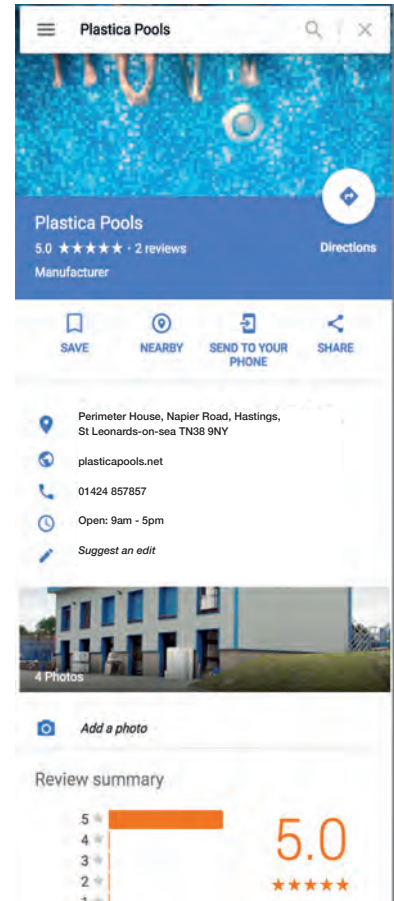

## We have a *24 hour* online ordering service just for you

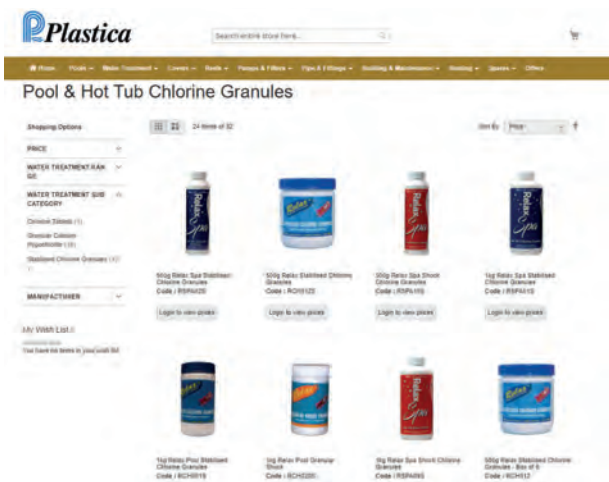

### HAVE YOU TRIED ORDERING ONLINE YET?

Now it's even easier and faster, here's just a few reasons why you should be ordering online:

- Real time stock levels and re-stock dates
- Online tracking
- Part Finder
- Access to product images, technical information and promotional literature
- Save 5% on delivery when you order online

If you would like a login to the system so you can start shopping online, please contact us on **01424 857802** or email [shoponline@plasticapools.net](mailto:shoponline@plasticapools.net)

**Check out our website:  
[www.plasticapools.net](http://www.plasticapools.net)**

# HERE TO HELP

## *Customer Service Team*

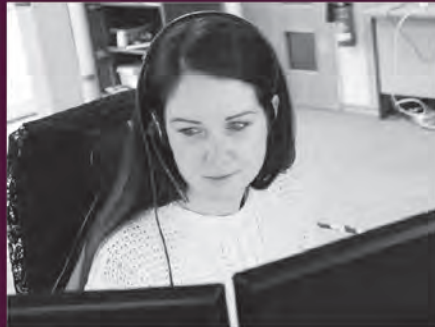

 01424 857802

 01424 857858

 [orders@plasticapools.net](mailto:orders@plasticapools.net)

 [www.plasticapools.net](http://www.plasticapools.net)

**How can we help you? Please get in touch...**

**Calls may be monitored or recorded for training purposes.**

**Calls may also be recorded when placing a verbal order to ensure the accuracy of the order.**



## **TOOLS OF THE TRADE**

Q-Vac, Lubricant, Winterising Plugs, Portapools, Submersible Pumps, Adhesives, Marketing Material, Pool Paint

**11-18**

## **LIGHTING & POOL FLOW**

Lighting, Skimmers, Auto Top Up, Main Drains, Inlets & Vacuum Points, Pipe & Fittings, Flexfit Pipe System, Flexible Rubber Connectors, Valves, Counter Current Systems

**19-44**

## **LINERS**

Corner Inserts, Foam & Felt Underlay, Liners & Liner Accessories, Extreme On-site Lining, Pond Liners, Step Units

**45-62**

## **PUMPS, FILTERS & HEATING**

Pumps, Filter Pump Packs, Filters, Valves, Backwash Hose, Filter Media, Cartridge Filters, Heat Pumps, Electric & Solar Heating

**63-96**

## **POOL SURROUND**

Copings, Easy Drain, Ladders, Handrails, Safety Fencing, Alarm System, Lifesaving Equipment, Solar Showers, Airdomes

**97-112**

## **COVERS & REELS**

Solar Covers, Leading Edge, Foam Covers, Reel Systems, Safety Covers, Cover Storage, Winter Debris Covers

**113-154**

## **POOL MAINTENANCE**

Poles, Vacuum Hose, Leaf Nets & Rakes, Brushes, Vacuum Heads, Maintenance Kits, Suction Cleaners, Leaf Traps, Automatic Cleaners, Thermometers

**155-164**

## **ABOVE GROUND**

Wooden Pools, Above Ground Pools & Accessories, Above Ground Pool Flow, Heating, Ladders & Covers

**165-200**

## **SPAS & ACCESSORIES**

IQUE Spas & Accessories

**201-212**

## **INFLATABLES & GAMES**

Paddling Pools, Loungers, Ride-ons, Inflatables, Tubes, Pumps, Games, Swimming Aids

**213-222**

## **WATER TREATMENT**

Chlorine, Bromine, Energize, pH Adjusters, Water Balance, Algicide, Winter Treatment, Speciality Products, Starter Kits, Spa Treatments, Fragrances, Salt Chlorine Generators, UV, Dosing Equipment, Test Strips & Kits, Quantum and Commercial Water Treatment

**223-254**



**FOLLOW US**



Join us on Facebook, Twitter, Instagram and LinkedIn for new product information, topical news and a first glance at our special offers. Take a look at our Youtube channel where you can see our latest installs, instructional videos and an external look at our facilities and equipment.

# Tools of the Trade

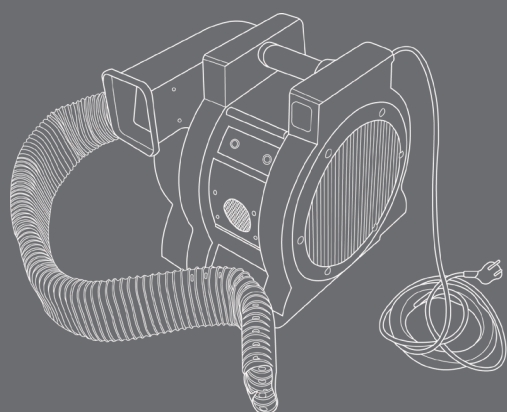

- All prices in the Tools of the Trade section are shown as nett only
- Discounts are not applicable on these products, regardless of where else they might appear in this catalogue
- A note will appear as a reminder in other sections when a product is available at nett price only

## Q-Vac

- Heavy duty vacuum system for fitting pool liners
- Quiet running (50db)
- High suction
- Supplied with 5' of Q-Flex Vacuum Hose



PRODUCT CODE	DESCRIPTION	PRICE EACH
QPR010	Q-Vac	£756.00

## Q-Flex

Q-Flex		
PRODUCT CODE	DESCRIPTION	PRICE EACH
QPR030	Q-Flex	£67.50

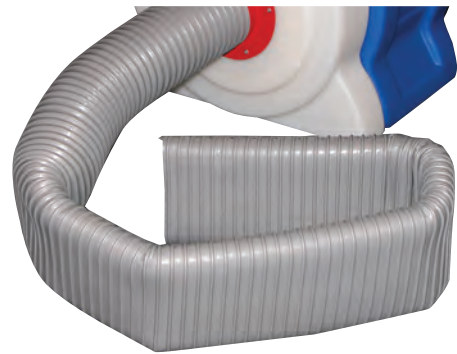

## Portapool

HEAVY ITEM



Portapool		
PRODUCT CODE	DESCRIPTION	PRICE EACH
PPP200	2m	£242.00
PPL450K	4.5m plus canvas carry bag	£1,040.00
PPL600K	6m plus canvas carry bag	£1,238.00

- **New** foam log inserts for top collar packed in pre-made bag
- Portable water storage tank
- 2m up to 375 gallons (1,700 litres) - ideal for spas
- 4.5m up to 4,100 gallons (18,600 litres)
- 6m up to 5,650 gallons (25,680 litres)
- Canvas carry bag included on 4.5m and 6m size



## O-Ring Repair Kit

- 1m x 1.5mm diameter
- 1m x 2.4mm diameter
- 1m x 3.2mm diameter
- 1m x 4.5mm diameter
- 1m x 6.5mm diameter
- Adhesive



A MUST FOR EVERY ENGINEERS TOOLBOX

### O-Ring Repair Kit

PRODUCT CODE	DESCRIPTION	PRICE EACH
GRK100	 O-Ring Repair Kit	£36.00

## Winterising Plugs

- Rubber plug with butterfly nut
- 1.25" to 2.5"



### Rubber Plugs

PRODUCT CODE	DESCRIPTION	PRICE EACH
PWP8000	1.25" to 1.5"	£3.00
PWP9000	1.5" to 2"	£3.00
PWP10000	2" to 2.5"	£3.50

## Pipe & Fitting Saver

- Reams old pipe material out of fittings for re-use.
- Requires a drill with a 12mm size chuck

### Pipe & Fitting Saver

PRODUCT CODE	DESCRIPTION	PRICE EACH
PFS-150	1.5" Fitting Saver	£88.85
PFS-200	2" Fitting Saver	£90.87

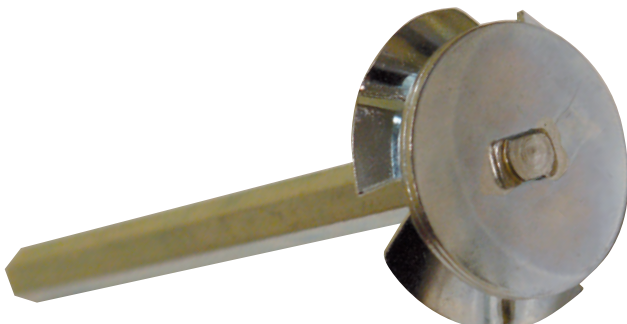

## Stainless Submersible Pump

- Stainless steel pump body
- Liquid temperature up to 35°C
- IPX8 protection
- 5mm maximum particle size
- 10m cable
- 900W motor
- 12,000 litres per hour
- Supplied with hoesetail. 1.25" male threaded to pump
- 22mm/1" male threaded
- 33mm to hose



### Stainless Submersible Pump

PRODUCT CODE	DESCRIPTION	PRICE EACH
PSP800	Stainless Submersible Pump	£99.00

## Premium Submersible Pump

- Plastic pump body
- Liquid temperature up to 35°C
- IPX8 protection
- 35mm maximum particle size
- 10m cable
- 250W motor
- 5,500 litres per hour
- Supplied with hoesetail. 1.25" male threaded to pump
- 22mm/1" male threaded
- 33mm to hose



### Premium Submersible Pump

PRODUCT CODE	DESCRIPTION	PRICE EACH
PSP700	Submersible Pump	£37.00

## Relax Pool Paints

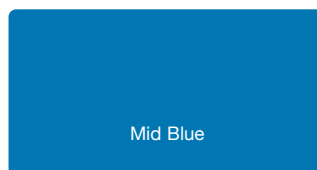
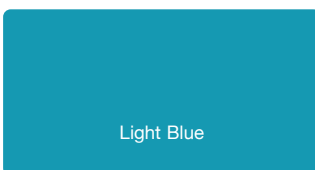

### Relax Pool Paints (5 Litres)

PRODUCT CODE	DESCRIPTION	PRICE EACH
RCH174	◆◆ Light Blue Chlorine Rubber - UN1263	£95.00
RCH175	◆◆ Mid Blue Chlorine Rubber - UN1263	£95.00
RCH178	◆ Light Blue Water Based	£96.00
RCH179	◆ Mid Blue Water Based	£96.00

5 litres of Relax Chlorine Rubber Pool Paint will cover 30m<sup>2</sup> approx.  
5 litres of Relax Water Based Pool Paint will cover 40m<sup>2</sup> approx.

All pool surfaces to be painted must be compatible with existing pool paint, cleaned and prepared to the manufacturers instructions.

Please allow one week for paint to dry.

Colours may vary slightly.



**Note:** Pool paint is now a nett price.

# Liner Adhesives & Repair

## Adhesives

PRODUCT CODE	DESCRIPTION	SUITABLE FOR	PRICE EACH
GLU001	⊛ Thixotropic Glue (5 litre)	Felt & Foam Underlay	£59.27
TAP003	⊛ Filament Tape 50mm x 50m	Felt & Foam Underlay	£11.90
ADH002	⊛ Box of 12 x 500ml Spray Adhesive	Felt & Foam Underlay	£54.50
PLR210	⊛ Professional PVC Adhesive (1 litre)	Liners	£44.05

## Repairs

PRODUCT CODE	DESCRIPTION	SUITABLE FOR	PRICE EACH
LRK102	⊛ Repair Kit (2oz) (140 x 560mm)	Liner Repair	£5.60
ZAP380	⊛ Self Adhesive Patch Kit	Liner Repair	£3.50

LRK102 can be used underwater



Spray Underlay Adhesive – ADH002



Thixotropic Glue – GLU001

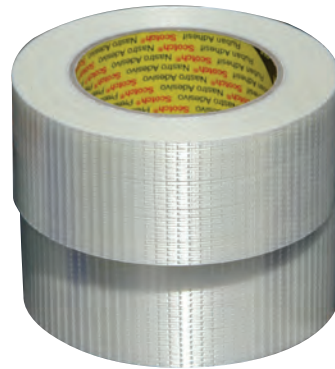

Filament Tape – TAP003

# Cover Repair

## Cover Repair

PRODUCT CODE	DESCRIPTION	SUITABLE FOR	PRICE EACH
PLR150	⊛ Cover Repair Tape 50mm x 33m roll	All Covers	£10.30
PLR255	⊛ Repair Material 0.15m (6") wide per m	Supercovers	£2.20

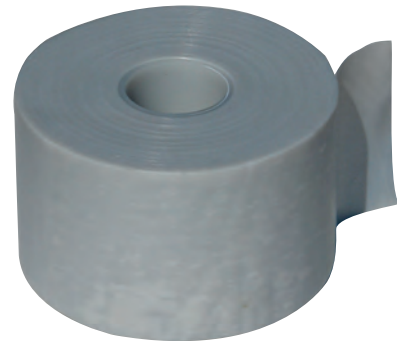

Cover Repair Tape – PLR150

# Linerlock Fixings

## Linerlock Screws (packs of 100)

PRODUCT CODE	DESCRIPTION	PRICE EACH
PLL515	⊛ No. 10 x 1"	£20.40
PLL560	⊛ No. 8 x 1" for Wideback Linerlock	£9.50
PLL510	⊛ No. 10 x 2" for Side Mount Linerlock	£17.70

## Linerlock Fixings (packs of 100)

PRODUCT CODE	DESCRIPTION	PRICE EACH
PLL530	⊛ Masonry Nails (25mm) for Wideback Linerlock	£8.80
PLL540	⊛ No. 10 x 3/8" Hex Headed self Drilling Screws	£10.70
PLL550	⊛ 23.5mm x 4.8mm Drive Rivets - 5mm drill	£26.50

**Note:** All these screws are stainless and self tapping.

## Mida Fix 3000

- Sealing and adhesive
- Usable underwater or above water
- Salt water and chlorine resistant
- Suitable for natural stone/white
- Paintable, sandable, durable and odourless



### Mida Fix 3000

PRODUCT CODE	DESCRIPTION	PRICE EACH
MF-60W	60g/40ml Polymer Tube	£9.24
MF-3000W	440g/290ml MS Polymer Cartridge	£34.50

## Rotabond 2000

- UV resistant
- Polymer based sealer and adhesive
- Solvent and isocyanate free
- Excellent adhesion to all surface



### Rotabond 2000

PRODUCT CODE	DESCRIPTION	PRICE EACH
ROT010	290ml White	£19.90

## FixStik AquaStik Repair Putty

- Underwater repair putty (fresh or salt)
- Used as an adhesive, filler or former
- Mixes in 1 minute for permanent repairs
- Hardening within one hour of application
- Cures to a density similar to concrete
- Turns to a white colour
- Bonds to fibreglass, tile, plastic metal, wood, concrete and glass



### FixStik AquaStik Repair Putty

PRODUCT CODE	DESCRIPTION	PRICE EACH
AQUASTIK	144g FixStik AquaStik Repair Putty	£9.62

## Magic Lube Lubricants



- Added protection and lubrication
- Waterproof and chemical resistant
- Can be used under adverse conditions

### Magic Lube II

PRODUCT CODE	DESCRIPTION	PRICE EACH
MAGI001	30g tube	£5.80



- Waterproof and chemical resistant
- Prevents rust and corrosion
- Wide temperature range
- PTFE based

### Magic Lube

PRODUCT CODE	DESCRIPTION	PRICE EACH
MAGI002	30g tube	£3.70

\*Both sold in singles but can come as a box of 25 (25 singles)

## Gauntlets

- Nitrile dipped
- 65cm
- Elasticated seal
- Chemical resistant
- Totally waterproof



### Gauntlets

PRODUCT CODE	DESCRIPTION	PRICE EACH
GAU001	65cm Gauntlets (as a pair)	£14.00

## Gasket Material & Step Unit Spares

### Self Adhesive Gasket Material

PRODUCT CODE	DESCRIPTION	PRICE EACH
LFG401	25m x 75mm Roll	£57.40
LFG403	1m sq Sheet	£24.40



For Roman Ends

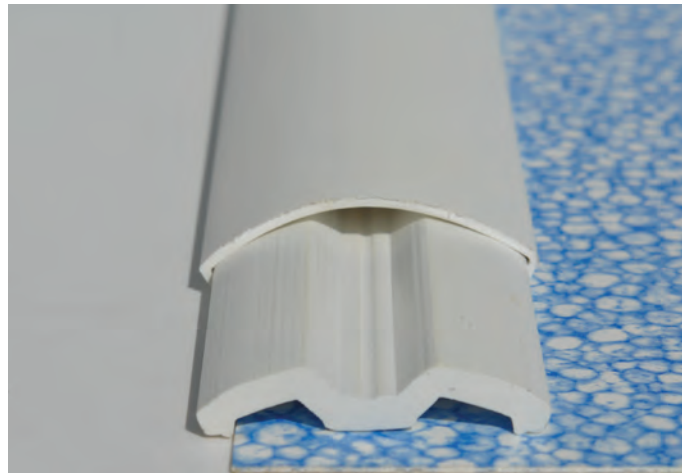

3.3m Clamp & Cover Plate – CCS001

**CCS001**  
Width = 4.5cm  
Depth = 1.5cm - 2cm

### 3.3m Clamp & Cover Plate

PRODUCT CODE	DESCRIPTION	PRICE EACH
CCS001	Undrilled	£37.81
LFG10104	Step unit white plastic cap	£1.20

## Plug Converter

### Plug Converter

PRODUCT CODE	DESCRIPTION	PRICE EACH
PLUGEU223	Converts Euro Schuko 2 pin & earth to standard UK plug	£3.10

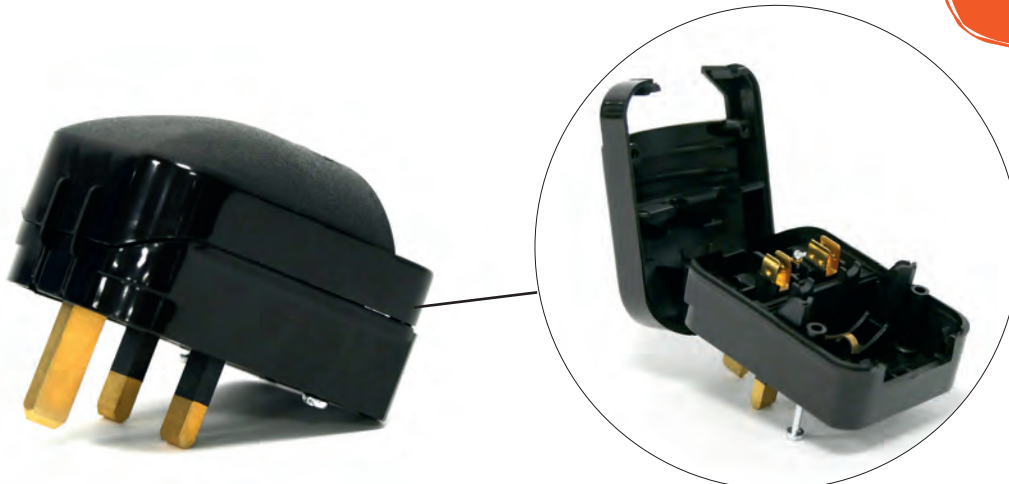

## Liner and Cover Sample Folders



### Cover Sample Folders

PRODUCT CODE	DESCRIPTION	PRICE EACH
LSF001	Liner Sample Folder	FOC
LSF002	Extreme Liner Sample Folder	FOC
CSF001	Cover Sample Folder	FOC

## Water Treatment Display

- Steel display stands for Pool Showrooms
- Complete with artwork
- 1m wide x 2m high x 530mm deep
- Individual units easily joined together

### Water Treatment Display Shelving

PRODUCT CODE	DESCRIPTION	PRICE EACH
DST300	Steel Display Stand	POA



For illustration purposes only

## Point of Sale

- Contact Customer Services or your Sales Representative for the latest product leaflets, posters or banners for your showroom
- Technical literature also available

# Pool Flow & Lighting

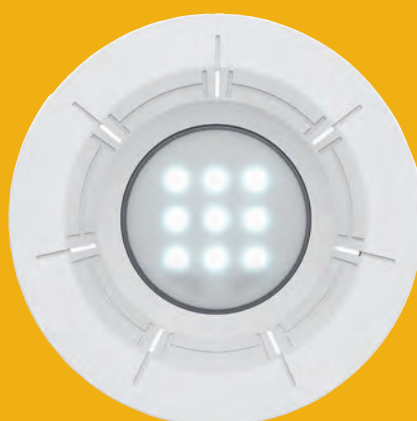
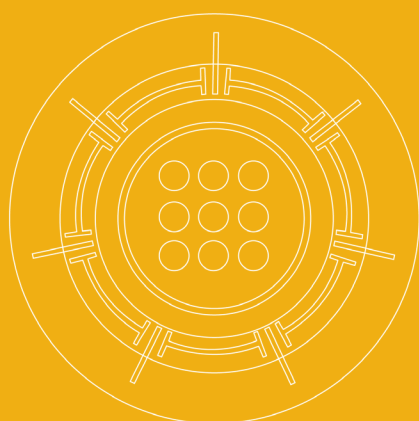



## Certikin Sealed Beam Lights (PU9)

LIGHTING & POOL FLOW



Liner Sealed Beam Light – PU91011NL



Concrete Sealed Beam Light – PU91011NC

### Complete Kit - Liner

DISCOUNT CODE/ PRODUCT CODE	DESCRIPTION	PRICE EACH
K2 PU91011NL	Liner	£685.40
K2 PU91011NL/2	Pack of 2 for Liner	£1,323.60

### Complete Kit - Concrete

DISCOUNT CODE/ PRODUCT CODE	DESCRIPTION	PRICE EACH
K2 PU91011NC	Concrete	£612.68
K2 PU91011NC/2	Pack of 2 for Concrete	£1,177.66

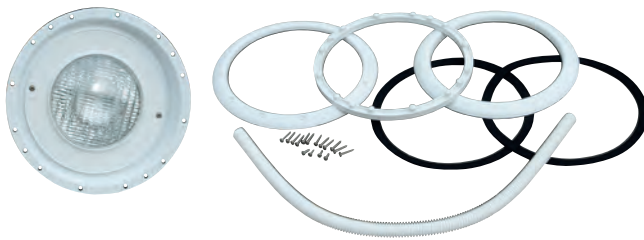

Light & Niche for liner – PU9LS



Light & Niche for concrete – PU9CS

### Basic Light Kit

DISCOUNT CODE/ PRODUCT CODE	DESCRIPTION	PRICE EACH
K2 PU9LS	Light & Niche for Liner (with conduit)	£277.53
K2 PU9LLTW	White LED Light & Niche for Liner (with conduit)	£397.50
K2 PU9LLTC	RGBW LED Light & Niche for Liner (with conduit)	£614.80

### Basic Light Kit

DISCOUNT CODE/ PRODUCT CODE	DESCRIPTION	PRICE EACH
K2 PU9CS	Light & Niche for Concrete (with conduit)	£225.78
K2 PU9CLTW	White LED Light & Niche for Concrete (with conduit)	£373.12
K2 PU9CLTC	RGBW LED Light & Niche for Concrete (with conduit)	£609.50



Guts Pack – PU93S



Deck Box – PU10N



Transformer (300W) – PU11S

### Guts Packs

DISCOUNT CODE/ PRODUCT CODE	DESCRIPTION	PRICE EACH
K2 PU93S	2.8m Cable 300W 12v	£185.39
K2 PU95S	5m Cable 300W 12v	£215.73
K2 PU93LTC	White LED 2.8m Cable	£309.52
K2 PU93LTC	RGBW LED 2.8m Cable	£551.20

### Accessories

DISCOUNT CODE/ PRODUCT CODE	DESCRIPTION	PRICE EACH
E PU15C	Impact Resistant Lens (clear)	£16.43
E PU10N	Deck Box	£29.68
K2 PU11S	Transformer (300W 12v) up to 7 RGBW Lights	£429.30
K2 PU11H	Transformer (120 VA 12v IP65) up to 4 White LED Lights	£337.08
K2 SPLT2002	Control Panel Receiver (requires SPLT001)	£498.20
K2 SPLT001	Remote Control (requires SPLT2002)	£254.40

## Underwater Lights

LIGHTING & POOL FLOW



Sealed Beam – EPF353

- 12 Watt 12 volt LED
- 1300 Lumens



LED006G

### Replacement Bulb (300W PAR56)

DISCOUNT CODE/ PRODUCT CODE	DESCRIPTION	PRICE EACH
E EPF353	Sealed Beam (300W 12v)	£42.00

### LED Replacement Bulb

DISCOUNT CODE/ PRODUCT CODE	DESCRIPTION	PRICE EACH
K2 LED006G	White PAR 56 LED Replacement Bulb (glass)	£112.00

- 3m cable
- Fixed Light



- 13.5 Watt 12 volt LED
- Directional fitting
- 3m cable
- Directional Light



### LED Fixed with Niche

DISCOUNT CODE/ PRODUCT CODE	DESCRIPTION	PRICE EACH
K2 PF10R294	WEM20 (20w white) in fixed liner/concrete niche	£245.00
K2 PF10R295	WEM40 (40w white) in fixed liner/concrete niche	£318.00
K2 PF10R195	WEM30 (36w RGBW) in fixed liner/concrete niche*	£345.00

### LED Directional with Niche

DISCOUNT CODE/ PRODUCT CODE	DESCRIPTION	PRICE EACH
E LED269	LED 13.5W - 12v Liner/Concrete light & Niche	£250.00

\* Note: PF10R195 will require a synchronisation panel to manage the colour change functions.



WEM20/WEM40/WEM30

### Eolia White LED Light Bulb

DISCOUNT CODE/ PRODUCT CODE	DESCRIPTION	PRICE EACH
K2 WEM20	White PAR 56 LED Light - 25W (1400lm)	£119.00
K2 WEM40	White PAR 56 LED Light - 40W (4400lm)	£190.00

### Eolia RGB LED Light Bulb

DISCOUNT CODE/ PRODUCT CODE	DESCRIPTION	PRICE LIST
K2 WEM30	RGBW PAR 56 LED Light – 36W (1140lm)	£264.00

The transformer option will depend on the amount of lights required. You can run up to 90% of the transformers capacity with lights. E.G. 6x LED006G = 72W – either ULT100 or PIMT31 will be fine. However 8x LED006G = 96W, so a PIMT33 will be required.

**All LED units are supplied with a two year guarantee.**

## LED Lighting Accessories

LIGHTING &  
POOL FLOW



PIMT31/PIMT33



ULT100

### 12V Transformers

DISCOUNT CODE/ PRODUCT CODE	DESCRIPTION	PRICE EACH
K2 PIMT31	Premium 12V Transformer - 100W with switch	£163.00
K2 PIMT33	Premium 12V Transformer - 300W with switch	£179.00
K ULT100	12V Transformer - 100W	£108.00



MOD RC+



BRIO WiL



BRIO100-RC



BRIO300-RC



BRIO-RC



Remote

### RGB Light Kit Accessories

DISCOUNT CODE/ PRODUCT CODE	DESCRIPTION	PRICE EACH
K2 MOD RC+	Synchronisation Panel (no transformer) Up to 1000w of lighting for large lighting designs. Supplied with remote control	£300.00
K2 BRIO WiL	RGBW Synchronisation Panel (no Transformer) Up to 120w of lighting. Smartphone, Alexa 2020 and Google Home 2020 compatible. Wheel controller for normal use.	£220.00
K2 BRIO100-RC	RGBW Synchronisation Panel with 100W Transformer	£241.00
K2 BRIO300-RC	RGBW Synchronisation Panel with 300W Transformer	£493.00
K2 BRIO-RC	Smart Synchronisation Panel (no transformer)	£145.00
S1 MPRD0104	Replacement Remote	£57.00

Once you have chosen your preferred light, you must choose a suitable transformer or synchronisation panel (even if you only have one light). You can run up to 90% of the transformers capacity with lights. You can also add mini chroma RGBW to your lighting scheme because they all use the same technology and will sync together.

E.G. 4x WEM30 (36W each) + 4x 15MB2 (12W each) = 192W, so a BRIO300-RC synchronisation panel will be required.

E.G. 4x PK10R316 (7W each) = 28W, so a BRIO100-RC synchronisation panel will be required.

E.G. 6x LED006G = 72W - either ULT100 or PIMT31 will be fine. However 8x LED006G = 96W, so a PIMT33 will be required.

**All LED units are supplied with a two year guarantee.**

## Mini LED Lights



- 6w - 700 Lumens
- No bezel required with LED003 Deck Box Kit
- Bezels available for other wall fittings below (not Certikin)



- 7w - 450 Lumens
- RGBW sychronisation kits available
- No bezel required with LED003 Deck Box Kit
- Bezels available for other wall fittings below (not Certikin)

### Mini Brio + White

DISCOUNT CODE/ PRODUCT CODE	DESCRIPTION	PRICE EACH
K2 PK10R314	Cool White Mini Brio +, 6w 700lm	£142.00

### Mini Brio + RGBW

DISCOUNT CODE/ PRODUCT CODE	DESCRIPTION	PRICE EACH
K2 PK10R316	RGBW Mini Brio + 7w 450lm	£226.00



- 12w - 1200 Lumens
- No bezel required with LED003 Deck Box Kit
- Bezels available for other wall fittings below (not Certikin)



- 12w - 900 Lumens
- RGBW sychronisation kits available
- No bezel required with LED003 Deck Box Kit
- Bezels available for other wall fittings below (not Certikin)

### Mini Brio 2 White

DISCOUNT CODE/ PRODUCT CODE	DESCRIPTION	PRICE EACH
K2 M12MB2	Mini Brio 2 12w 1200lm	£215.00

### Mini Brio 2 RGBW

DISCOUNT CODE/ PRODUCT CODE	DESCRIPTION	PRICE EACH
K2 X15MB2	RGBW Mini Brio 2 12w 900lm	£298.00

## Additional Options

DISCOUNT CODE/ PRODUCT CODE	DESCRIPTION	PRICE EACH
K2 PF10R153	White ABS Bezel compatible with Mini Brio 2 or Mini Brio+	£12.00
K2 PF10R158	Stainless Mini-Nova Bezel compatible with Mini Brio 2 and Mini Brio + for all pools	£68.00
K2 PF10R154	Stainless Mini-Bahia Bezel compatible with Mini Brio 2 and Mini Brio + for concrete pools	£68.00
K2 LED003	Deck Box and wall fitting in white, suitable for Mini Brio + and Mini Brio 2 without need for separate bezel	£87.00
K2 END036	Mini Brio +, Mini Brio 2 Liner/Concrete Wall fitting	£25.00

**Note:** END036 is the wall fitting for the MB lights only. Provisions will have to be made if only taking this fitting.



END036



LED003

# Chroma Universal LED Lights

LIGHTING & POOL FLOW

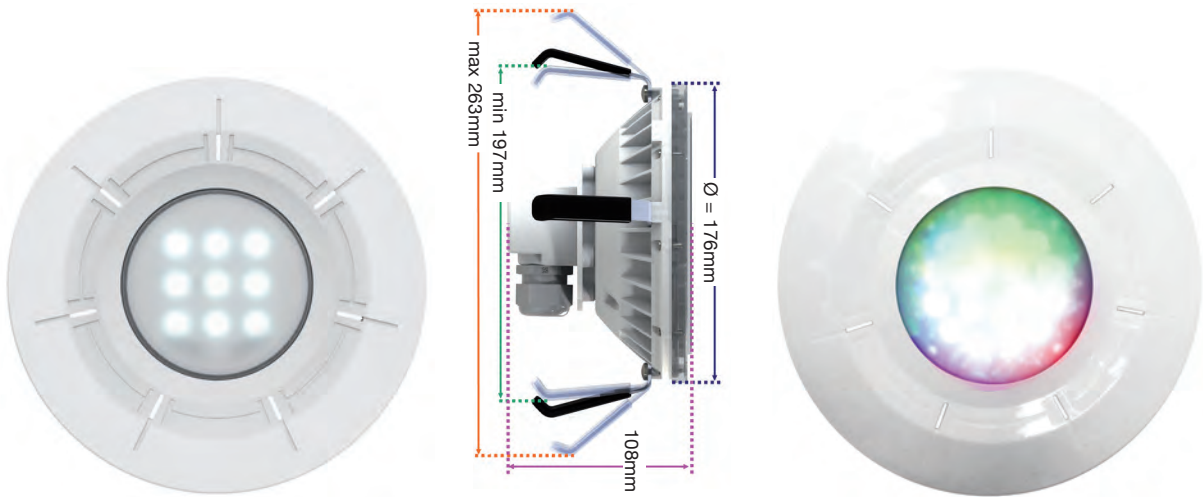

- Adjustable to fit most underwater light niches
- 3m cable supplied
- 20W = 1400 lumens 40W - 4400 lumens
- White Bezel 260mm diameter included

- Adjustable to fit most underwater light niches
- 3m cable supplied
- 1150 lumens
- Remote synchronisation kit available
- White Bezel 260mm diameter included

White		
DISCOUNT CODE/ PRODUCT CODE	DESCRIPTION	PRICE EACH
K2 WCM20	Universal Chroma White LED Light - 20W	£221.00
K2 WCM40	Universal Chroma White LED Light - 40W	£265.00

RGBW		
DISCOUNT CODE/ PRODUCT CODE	DESCRIPTION	PRICE EACH
K2 WCX30	RGBW Universal Chrome - 36W	£338.00

White Light Kit Accessories		
DISCOUNT CODE/ PRODUCT CODE	DESCRIPTION	PRICE EACH
K2 BAHIA	SS Bezel 316L extra thin for concrete pools	£159.00
K2 NOVA	SS Bezel 316L for liner pools 106mm	£159.00
K ULT100	12V Transformer – 100W	£108.00
K2 PIMT31	Premium 12V Transformer – 100W with switch	£163.00
K2 PIMT33	Premium 12V Transformer – 300W with switch	£179.00

RGB Light Kit Accessories		
DISCOUNT CODE/ PRODUCT CODE	DESCRIPTION	PRICE EACH
K2 BAHIA	SS Bezel 316L extra thin for concrete pools	£159.00
K2 NOVA	SS Bezel 316L for liner pools 106mm	£159.00
K2 BRIO-RC	RGBW Synchronisation Panel (no Transformer)	£145.00
K2 BRIO100-RC	RGBW Synchronisation Panel with 100W Transformer	£241.00
K2 BRIO300-RC	RGBW Synchronisation Panel with 300W Transformer	£493.00
K2 MOD RC+	Synchronisation Panel 1000w (no transformer)	£300.00
K2 BRIO WiL	Smart Synchronisation Panel (no transformer)	£220.00



PIMT31/PIMT33



ULT100



BRIO WiL



MOD RC+



BRIO100-RC



BRIO-RC



BRIO300-RC

The white Universal Chroma LED lights will work on an existing transformer when retro fitting. If retro fitting an RGBW Universal Chroma with an existing transformer a BRIO-RC can be installed (up to 90W of lights, providing the original transformer is big enough).

If the installation of RGBW Chroma Universal does not have an existing transformer, either a BRIO100-RC or BRIO300-RC will need to be installed.

Once you have chosen your preferred light you must choose a suitable transformer or synchronisation panel (even if you only have one light).

You can run up to 90% of the transformer's capacity with lights.

**All LED units are supplied with a two year guarantee.**



# Certikin Skimmers

- Robust one piece body
- Through the wall design
- Overflow and water fill outlets provided
- Extending collar and square frame for easy installation
- For both liner and concrete pools
- Wide angle and parallel throat
- Flap or collar weir models
- Maximum flow is 4.5m<sup>3</sup> per hour
- Adjustable flow restrictor
- Optional extension throats allow the skimmer to be positioned any distance from the pool wall

LIGHTING & POOL FLOW

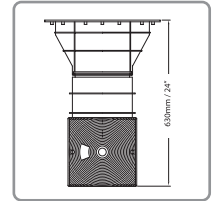

Liner Weir Type – HD1001SLS

## Concrete Weir Type

DISCOUNT CODE/ PRODUCT CODE	DESCRIPTION	PRICE EACH
E HD100SN	Skimmer Collar Weir	£174.90
E HD1001SCS	Collar Weir Wide Angle Extension Throat (Plumbed)	£240.62

## Liner Weir Type

DISCOUNT CODE/ PRODUCT CODE	DESCRIPTION	PRICE EACH
E ZZ0259	Skimmer (inc. HD100LAK)	£220.48
E HD1001SLS	Collar Weir Wide Angle Extension Throat (Plumbed)	£254.40

## Skimmer Accessories

DISCOUNT CODE/ PRODUCT CODE	DESCRIPTION	PRICE EACH
E HD105	Skimmer Conversion Kit (Flap to Collar Weir)	£38.69
E HD103	Vacuum Kornea	£18.02
K HD100LAK	Skimmer Adaptor Kit	£41.87

## Concrete Extension Throats

DISCOUNT CODE/ PRODUCT CODE	DESCRIPTION	PRICE EACH
E HD102	Parallel Extension	£55.12
E HD101CS	Wide Angle Extension	£62.54

## Liner Extension Throats

DISCOUNT CODE/ PRODUCT CODE	DESCRIPTION	PRICE EACH
E HD102LN	Parallel Extension + Liner Adaptor Kit	£94.34
E SPC4031N	2" Lid Frame Extender	£24.91

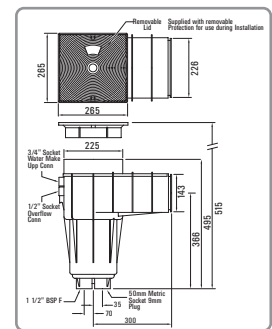

Concrete Weir Type – HD100SN  
Adjustable flow restrictor for bottom connection

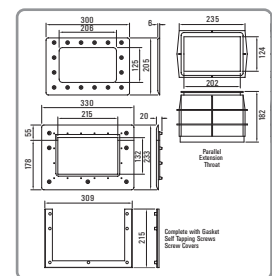
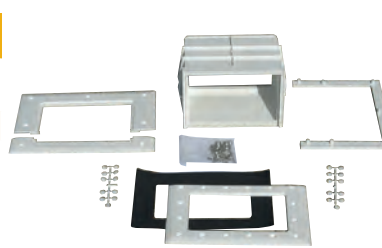

Liner Extension Throats – HD102LN

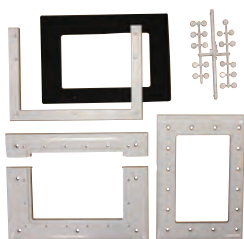

Adapter Kit – HD100LAK

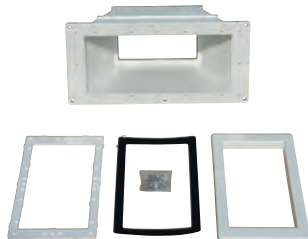

Wide Extension – HD101LT



Conversion Kit – HD105



Vacuum Kornea – HD103

## Aquareva Skimmer

Aquareva skimmers embody the latest in technological innovation to guarantee reliability and quality.

- Made of pool grade anti-UV treated ABS
- Self-adhesive elastomer gaskets
- Stainless steel screws, adapted to each type of pool
- Adhesive covers for protection at the work site
- Skims the water from the surface of the pool
- Captures large debris (leaves, toys, large insects, etc.)

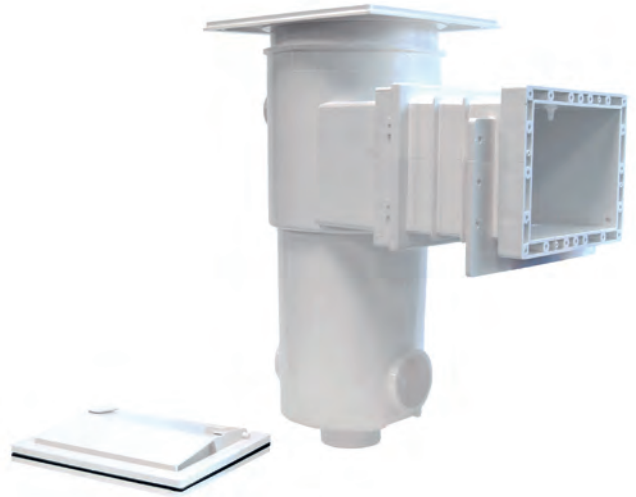

### Aquareva Skimmer

DISCOUNT CODE/ PRODUCT CODE	DESCRIPTION	PRICE EACH
E EPF40031000	Liner Flap Weir Skimmer	£155.00

## Intex Above Ground Pool Skimmer

- Mounts to Easy Set or Prism Frame Pool with adjustable bracket
- Attached to filter pump for automatic skimming
- Strainer basket pulls out for easy cleaning
- Requires Intex pump with minimum flow rate of 3,000 litres per hour



### Skimmers

DISCOUNT CODE/ PRODUCT CODE	DESCRIPTION	PRICE EACH
L 28000/E	Wall Mount Surface Skimmer	£28.00

## Above Ground Pool Skimmer & Inlet

### Standard

DISCOUNT CODE/ PRODUCT CODE	DESCRIPTION	PRICE EACH
L ENS100	Standard Skimmer & Inlet	£45.00

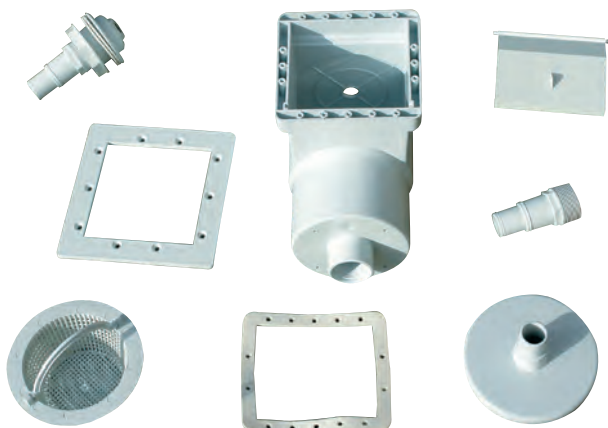

### Wide Angle

DISCOUNT CODE/ PRODUCT CODE	DESCRIPTION	PRICE EACH
L ENS110	Wide Angle Skimmer & Inlet	£53.00

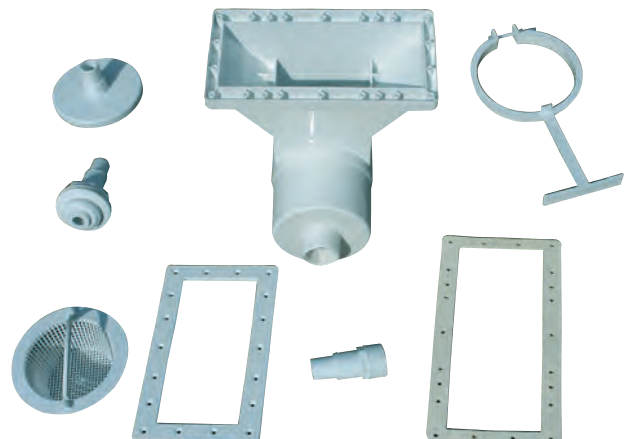

## Netskim®

- Less frequent cleaning of the filter pump basket
- High protection of the pump and all the equipment
- Easier pool maintenance
- Captures debris
- Display Box = 36 individual boxes containing 12 pieces



LIGHTING & POOL FLOW

### Netskim®

DISCOUNT CODE/ PRODUCT CODE	DESCRIPTION	PRICE EACH
K NET001	Box of 12	£17.96
K NET036	Display Box of 36 boxes	£592.28

## Skimmer Socks

- Reduce the need to clean skimmer baskets
- Easier pool maintenance
- High protection of the pump and all the equipment



### Skimmer Socks

DISCOUNT CODE/ PRODUCT CODE	DESCRIPTION	PRICE EACH
K SKS001	Skimmer Socks (box of 10)	£7.50

## Water Lily®

- Absorbs oils and creams
- Protection of the waterline
- Purification of the surface water
- Absorbing action until saturation
- Display box = 36 individual boxes containing 6 pieces each



### Water Lily®

DISCOUNT CODE/ PRODUCT CODE	DESCRIPTION	PRICE EACH
K WLL001	Water Lily	£11.06
K WLL036	Display box of 36 boxes	£364.84

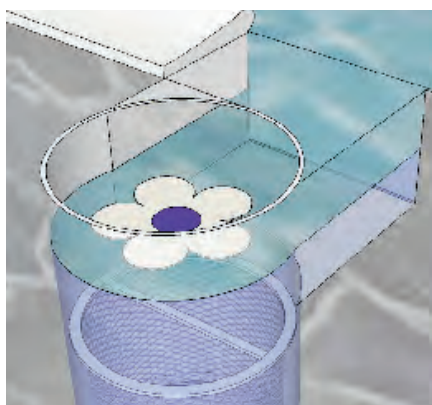

Before



After





# Certikin Main Drain

LIGHTING & POOL FLOW

## Concrete

DISCOUNT CODE/ PRODUCT CODE	DESCRIPTION	PRICE EACH
E HD33	6" with Anti-Vortex Grille (White)	£47.97

## Liner

DISCOUNT CODE/ PRODUCT CODE	DESCRIPTION	PRICE EACH
E HD33LT	6" with Anti-Vortex Grille (White)	£60.63

## Accessories

DISCOUNT CODE/ PRODUCT CODE	DESCRIPTION	PRICE EACH
E HD34	Hydro Relief Valve - ABS (1.5")	£15.74
E CK34S	Hydro Relief Valve - Brass (1.5")	£99.64
E HD35	Collection Tube (1.5")	£11.13
E CK33S	Main Drain Grille - Stainless Steel	£68.90
K SPC266N	High Flow Low Velocity ABS Grille	£33.92



Main Drain – HD33L



ABS Hydro Relief Valve – HD34



Brass Hydro Relief Valve – CK34S



Collection Tube – HD35



Stainless Steel Grille – CK33S

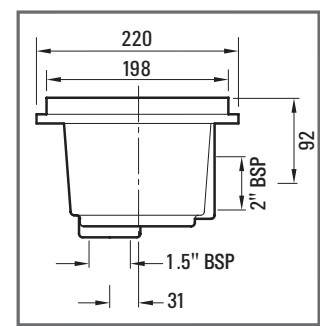

Concrete

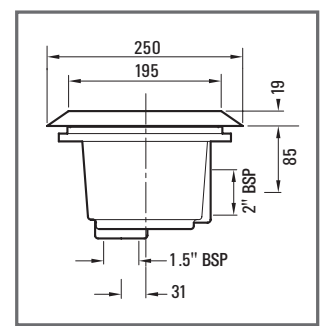

Liner

# Certikin Inlets

## 1.5" & 2" Concrete

DISCOUNT CODE/ PRODUCT CODE	DESCRIPTION	PRICE EACH
E HD54C/5	Fixed Grate (1.5") 5 No.	£75.26
E ZHD54C	Plumbed Fixed Grate - Low Suction (1.5") Single	£34.45
E HD5015	Adjustable (1.5") Single	£13.78
E HD502	Adjustable (2") Single	£15.79
E HD55/2	Non Leak Flange (Puddle Flange) 250mm	£43.99



Non Leak Flange – HD55/2



Adjustable Inlet – HD5015



Back Nut – SPC493



# Certikin Inlets

LIGHTING & POOL FLOW

## 1.5" Liner

DISCOUNT CODE/ PRODUCT CODE	DESCRIPTION	PRICE EACH
E HD54LT/5	Fixed Grate without Back Nut 5 No.	£124.02
E ZHD54LT	Plumbed Fixed Grate - Low Suction Single	£42.40
E HD54PLT/5	Fixed Grate for Panel Pool with Back Nut 5 No.	£163.24
K SPC493	Back Nut Single	£10.07

## 1.5" Liner Eyeball

DISCOUNT CODE/ PRODUCT CODE	DESCRIPTION	PRICE EACH
E HD53LT/5	Eyeball without Back Nut 5 No.	£124.02
E ZHD53LT	Plumbed Eyeball Single	£42.40
E HD53PLT/5	Panel Pool with Back Nut 5 No.	£163.24

## 1.5" Concrete

DISCOUNT CODE/ PRODUCT CODE	DESCRIPTION	PRICE EACH
E HD53C/5	Eyeball 5 No.	£77.38
E ZHD53C	Plumbed Eyeball Single	£33.92



Fixed Grate – HD54LT/5

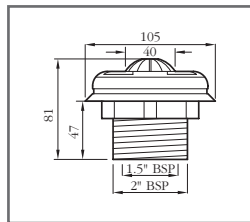

Eyeball – HD53LT/5

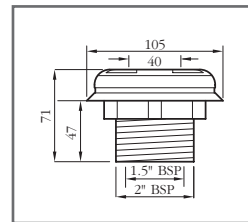

Fixed Grate with Back Nut – HD54PLT/5

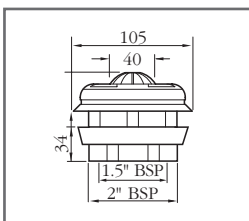

Eyeball – HD53PLT/5

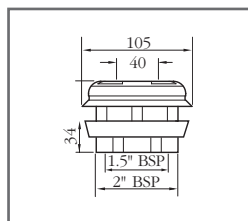

Fixed Grate – HD54C/5

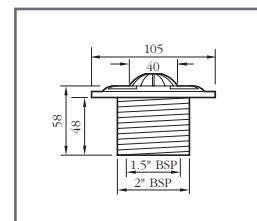



## Certikin Vacuum Points

LIGHTING & POOL FLOW

### 1.5" Concrete

DISCOUNT CODE/ PRODUCT CODE	DESCRIPTION	PRICE EACH
E HD20/5	with Plug (White) 5 No.	£63.60
E ZHD20C	with Plumbed Pipe approx 550mm (white) Single	£39.22

### 1.5" Liner

DISCOUNT CODE/ PRODUCT CODE	DESCRIPTION	PRICE EACH
E HD20LT/5	with Plug (White) 5 No.	£121.90
E ZHD20LT	with Plumbed Pipe approx 550mm (white) Single	£48.23
E HD20PLT/5	for Panel Pool (White) 5 No.	£138.86

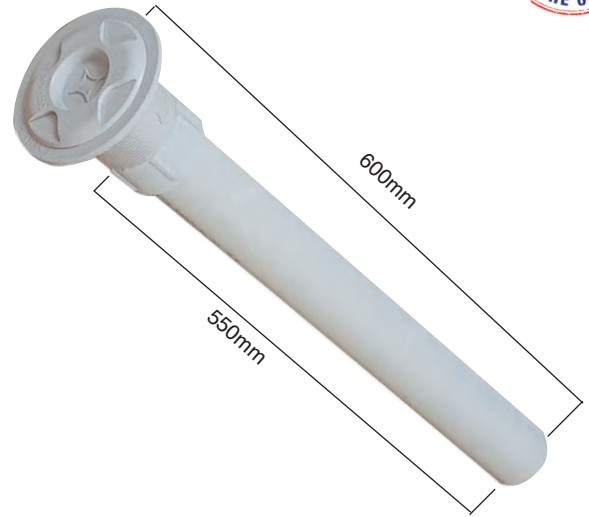

Plumbed Vacuum Point – ZHD20L/T



Vacuum Point – HD20/5



Vacuum Point – HD20LT/5

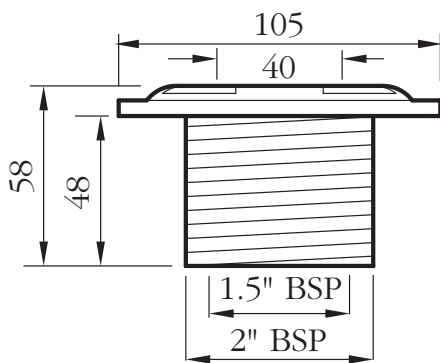

HD20/5

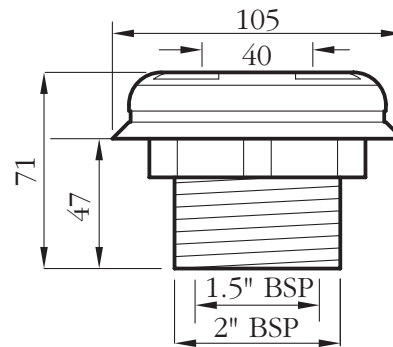

HD20L/5

## Certikin Auto Top-up

- 1.5" female thread BSP
- Female thread 1.5" outlet
- Some authorities require a non-return valve

### Auto Top-up

DISCOUNT CODE/ PRODUCT CODE	DESCRIPTION	PRICE EACH
E HD108	Certikin Top-up	£195.04



## Liner Inlet

- 50mm F/P Connection.
- Use PPF100 for 1.5" pipe
- Ideal for use with mini chroma light

### Liner Inlet

DISCOUNT CODE/ PRODUCT CODE	DESCRIPTION	PRICE EACH
K 42000000	Liner Inlet with 50mm F/P Connection	£23.00
K PPF100	50mm - 1.5" reducer	£1.70



Liner Inlet with 50mm – 42000000

LIGHTING &  
POOL FLOW

## Flow Switch

- 1.5" slip fit

### Flow Switch

DISCOUNT CODE/ PRODUCT CODE	DESCRIPTION	PRICE EACH
K 1970	25 Amp Flow Switch	£198.22



## Pipe Repair / Connectors

- A – 1.5" Pipemate glues inside 1.5" pipe to extend it by 30mm
- B – 2" Pipemate glues inside 2" pipe to extend it by 45mm
- C – 1.25"/1.5" female 1.5" plain hosetail
- D – 1.25"/1.5" male 1.5" plain hosetail

- C and D can connect together to make a vac hose/backwash hose connector for 1.25"/1.5" hose.

### Pipe Repair / Connectors

DISCOUNT CODE/ PRODUCT CODE	DESCRIPTION	PRICE EACH
K FPF160	1.5" Pipemate (A)	£3.53
K FPF260	2" Pipemate (B)	£4.93
K FPF165	1.25" / 1.5" plain hosetail (C)	£3.93
K FPF170	1.25" / 1.5" male 1.5" plain hosetail (D)	£3.93

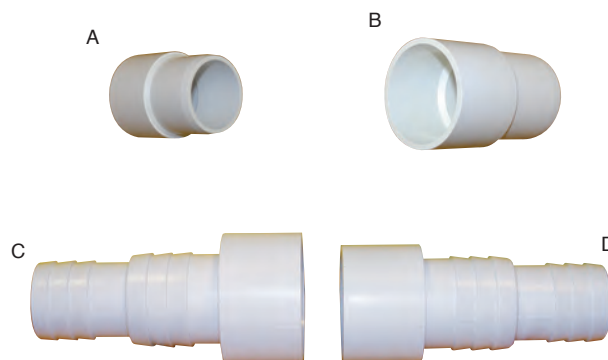

## Flexfit Pipe System

- For plumbing between pool and concrete filtration base
- Reduces the number of fittings required

- PVC hose bends to the shape of the pool
- Quicker and simpler to use

LIGHTING &  
POOL FLOW



Tee Piece Comp/Comp/Comp



Tee Piece Comp/FP/FP



90° Comp/Comp



90° Comp/FP



90° Comp/MT



Socket Comp/FP



Socket Comp/MT



Socket Comp/MP



Socket Comp/Comp

### 50mm

DISCOUNT CODE/ PRODUCT CODE	DESCRIPTION	PRICE EACH
C2 FPF105	25m Roll of Flexfit Pipe	£168.50
C2 FPF106	50m Roll of Flexfit Pipe	£306.36
C2 FPF110	Tee Piece (Comp - Comp - Comp)	£25.60
C2 FPF115	Tee Piece (Comp - 1.5" F/P - 1.5" F/P)	£11.10
C2 FPF120	90° (Comp - Comp)	£15.20
C2 FPF125	90° (Comp - 1.5" F/P)	£10.50
C2 FPF130	90° (Comp - 1.5" M/T)	£10.50
C2 FPF135	Socket (Comp - 1.5" F/P)	£10.50
C2 FPF140	Socket (Comp - 1.5" M/T)	£11.60
C2 FPF145	Socket (Comp - 1.5" M/P)	£9.90
C2 FPF150	Socket (Comp - Comp)	£16.90
C2 FPF155	Installation Key	£3.40

### 63mm

DISCOUNT CODE/ PRODUCT CODE	DESCRIPTION	PRICE EACH
C2 FPF205	25m Roll of Flexfit Pipe	£244.38
C2 FPF210	Tee Piece (Comp - Comp - Comp)	£39.00
C2 FPF220	90° (Comp - Comp)	£28.00
C2 FPF225	90° (Comp - 2" F/P)	£18.06
C2 FPF235	Socket (Comp - 2" F/P)	£16.00
C2 FPF240	Socket (Comp - 2" M/T)	£16.00
C2 FPF245	Socket (Comp - 2" M/P)	£15.00
C2 FPF250	Socket (Comp - Comp)	£28.00
C2 FPF255	Installation Key	£3.40

### Adaptors

DISCOUNT CODE/ PRODUCT CODE	DESCRIPTION	PRICE EACH
K FPF001	1.5" M/P - 50mm F/P Adaptor*	£6.15
K FPF002	1.5" F/P - 50mm F/P Straight Connector**	£6.77
K FPF003	50mm - 50mm Straight Connector***	£7.20



Installation Key

\*For connecting Flexfit pipe to a socket  
 \*\*For connecting Flexfit pipe to 1.5" ABS pipe  
 \*\*\*For connecting Flexfit pipe to Flexfit pipe

**Note:** Flexfit Pipe and fittings are not suitable for use on automatic pool cleaner pressure lines. We do not recommend that the adaptors FPF001, FPF002, FPF003 are used below ground level.

## Flexible Rubber Connectors

- Reduce stress and vibration
- Ideal for pipe repairs and for use as temporary fittings
- Removable and re-usable
- Supplied with stainless steel clips

LIGHTING & POOL FLOW

### Rubber Connectors

DISCOUNT CODE/ PRODUCT CODE	DESCRIPTION	PRICE EACH
K FRC005	1.5" Flexible Rubber Connector	£4.10
K FRC010	2" Flexible Rubber Connector	£4.50
K FRC015	2" to 1.5" Flexible Rubber Reducing Connector	£4.50
K FRC020	1.5" Flexible Rubber Bend	£8.95
K FRC025	2" Flexible Rubber Bend	£9.70
K FRC030	1.5" Flexible Rubber Tee	£10.40
K FRC035	2" Flexible Rubber Tee	£11.85
K FRC040	1.5" Flexible End Cap	£2.50
K FRC045	2" Flexible End Cap	£2.80

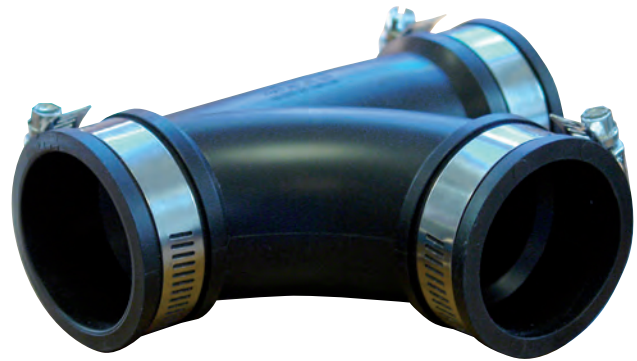

# NEED SPARES? NO *Problem*

Contact our Customer Service team for your copy of our 2022 Spares Price List (see p.8)

A5 *Size*



# 1.5" Pipe & Fittings

LIGHTING & POOL FLOW

## Class C Pipe

DISCOUNT CODE/ PRODUCT CODE	DESCRIPTION	NO. IN PACK	PRICE EACH
C PPF1015	1.5in Class C Pipe 3m length White	5	£149.65
C PPF1038	1.5in Class C Pipe 1.5m length	8	£119.40
C PPF0015	1in Class C Pipe 3 Metre length White	5	£78.30

## Sockets

DISCOUNT CODE/ PRODUCT CODE	DESCRIPTION	NO. IN PACK	PRICE EACH
C PPF10510	1.5in Socket PP White (A)	10	£27.45
C PPF105C10	1.5in to 50mm Socket Reducer PP White	10	£35.50
C PPF10610	1.5in Socket P FT White (B)	10	£37.50

## T Joint & Elbows

DISCOUNT CODE/ PRODUCT CODE	DESCRIPTION	NO. IN PACK	PRICE EACH
C PPF10710	1.5in T Joint P P P White (C)	10	£50.00
C PPF10810	1.5in 90° Deg Elbow P P White (D)	10	£30.15
C PPF10910	1.5in 45° Deg Elbow P P White (E)	10	£29.40

## Nipples

DISCOUNT CODE/ PRODUCT CODE	DESCRIPTION	NO. IN PACK	PRICE EACH
C PPF11010	1.5in Socket Nipple P MT White (F)	10	£26.15
C PPF11110	1.5in Nipple MP MT White (G)	10	£35.00

## Unions

DISCOUNT CODE/ PRODUCT CODE	DESCRIPTION	NO. IN PACK	PRICE EACH
C PPF1125	1.5in Socket Union P P White (H)	5	£49.90
C PPF1135	1.5in Socket Union MT P 50mm White (J)	5	£48.30
C PPF1365	1.5in Socket Union MT P 30mm Length White (K)	5	£49.95
C PPF1335	1.5in Socket Union P FT White (L)	5	£50.90
C PPF115	1.5in Composite Union P MT White Single	1	£41.85
C PPF116	1.5in Composite Union P FT White Single	1	£37.05

## Hosetails

DISCOUNT CODE/ PRODUCT CODE	DESCRIPTION	NO. IN PACK	PRICE EACH
C PPF12110	1.5in Hosetail Plain White (Q)	10	£19.65
C PPF13810	1.5in Hosetail Plain 65mm Length White (Q)	10	£25.00
C PPF12210	1.5in Hosetail Threaded 50mm White (R)	10	£22.75
C PPF13710	1.5in Hosetail Threaded 65mm Length White (R)	10	£24.95

## Reducers

DISCOUNT CODE/ PRODUCT CODE	DESCRIPTION	NO. IN PACK	PRICE EACH
K PPF100	50mm to 1.5in Reducer Plain Black (T)	1	£1.70
C PPF12310	2in to 1.5in Threaded Reducer White (S)	10	£30.65
C PPF12410	2in to 1.5in Plain Reducer White (T)	10	£26.80
C PPF32510	63mm to 50mm Plain Reducer White	10	£23.85
C PPF32610	2in to 50mm Plain Reducer White	10	£23.85
C PPF32710	63mm to 1.5in Plain Reducer White	10	£23.85

## Miscellaneous

DISCOUNT CODE/ PRODUCT CODE	DESCRIPTION	NO. IN PACK	PRICE EACH
C PPF11410	1.5in End Cap White	10	£31.25
C PPF11710	1.5in Threaded Plug White (M)	10	£20.75
C PPF11810	1.5in MP FT Adaptor White (N)	10	£31.80
C PPF11950	1.5in Pipe Clip White (P)	50	£83.75
E PPF120	Double Union Ball Valve	1	£21.00
H PPF296	1.25in Threaded Hose Tail - 40mm lengths (R)	1	£5.00

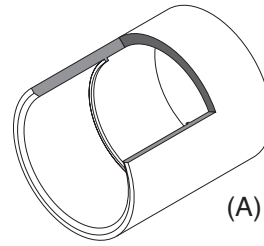

Socket P/P

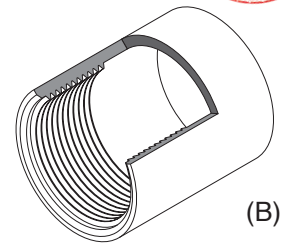

Socket P/FT

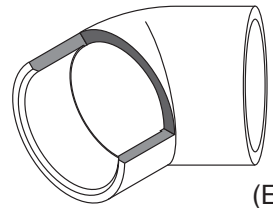

45° Elbow P/P

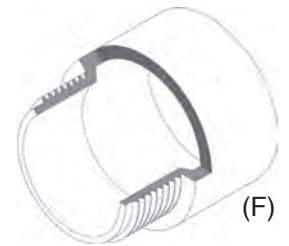

Socket Nipple P/MT

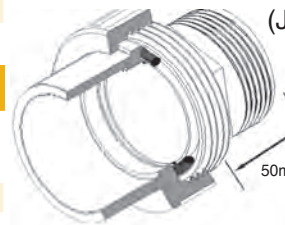

Socket Union P/MT

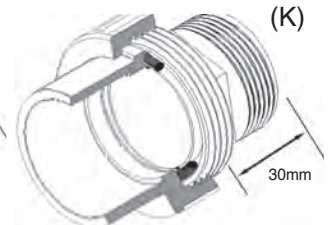

Socket Union P/MT

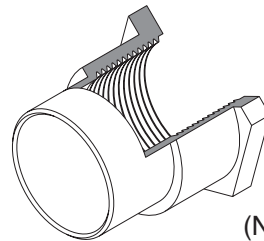

MP/FT Adaptor

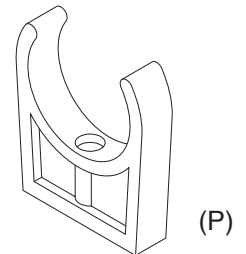

Pipe Clip

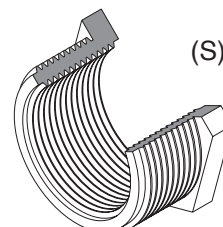

Threaded Reducer

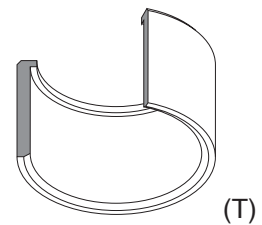

Plain Reducer



## 2" Pipe & Fittings

LIGHTING & POOL FLOW

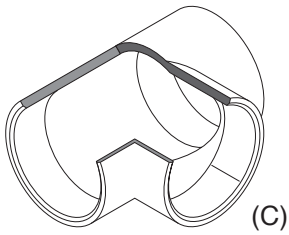

'T' P/P/P

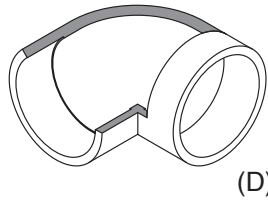

90° Elbow P/P

### Class C Pipe

DISCOUNT CODE/ PRODUCT CODE	DESCRIPTION	NO. IN PACK	PRICE EACH
C PPF2015	2in Class C Pipe 3 m length White	5	£222.30

### Sockets

DISCOUNT CODE/ PRODUCT CODE	DESCRIPTION	NO. IN PACK	PRICE EACH
C PPF20510	2in Socket P P White (A)	10	£44.55
C PPF205C10	2in to 63mm Socket Reducer P P White	10	£46.15
C PPF20610	2in Socket P FT White (B)	10	£57.90

### T Joint & Elbows

DISCOUNT CODE/ PRODUCT CODE	DESCRIPTION	NO. IN PACK	PRICE EACH
C PPF20710	2in T Joint P P P White (C)	10	£81.70
C PPF20810	2in 90° Deg Elbow P P White (D)	10	£66.15
C PPF20910	2in 45° Deg Elbow P P White (E)	10	£60.05

### Nipples

DISCOUNT CODE/ PRODUCT CODE	DESCRIPTION	NO. IN PACK	PRICE EACH
C PPF21010	2in Socket Nipple P MT White (F)	10	£43.35
C PPF21110	Nipple P/MT (G)	10	£41.95

### Socket Unions

DISCOUNT CODE/ PRODUCT CODE	DESCRIPTION	NO. IN PACK	PRICE EACH
C PPF2125	2in Socket Union P P White (H)	5	£74.00
C PPF2135	2in Socket Union P MT White (J)	5	£74.95
C PPF2335	2in Socket Union P FT White (L)	5	£69.85
C PPF215	2in Composite Union P MT White	1	£57.65
C PPF216	2in Composite Union P FT White	1	£49.85

### Miscellaneous

DISCOUNT CODE/ PRODUCT CODE	DESCRIPTION	NO. IN PACK	PRICE EACH
C PPF25025	2in Pipe Clip White (P)	25	£48.10
E MPF504	Double Union Ball Valve	1	£39.00

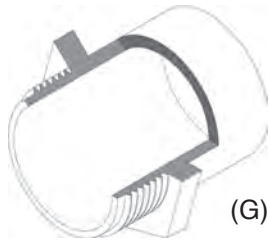

Nipple MP/MT

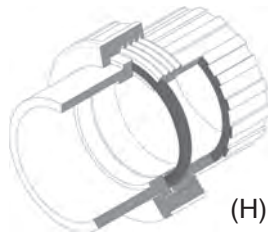

Socket Union P/P

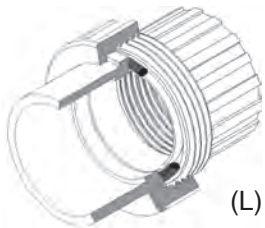

Socket Union P/FT

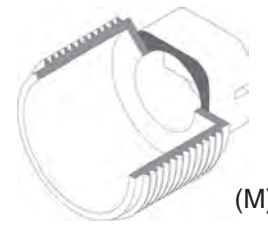

Threaded Plug

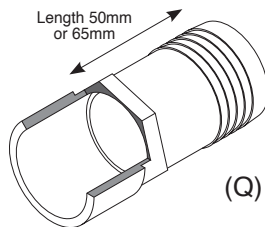

Hosetail Plain

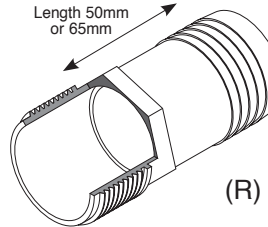

Hosetail Threaded

MOQ = Contact Customer Services for quote and minimum order requirement  
 Note: ABS pipe should not be used where ozone is present  
 ABS Pipe and Pipe Fittings are sold in pack sizes only

Maximum temperature 70°C (158°F)

P = Pipe Socket MP = Male Plain FT = Female Thread MT = Male Thread

## PVC Pipe & Fittings

### Pipe (3m lengths)

DISCOUNT CODE/ PRODUCT CODE	DESCRIPTION	PRICE EACH
H PVC005	0.5"	£5.99
H PVC010	0.75"	£8.54
H PVC015	1"	£10.98
H PVC020	1.25"	£17.42
H PVC025	1.5"	£22.34
H PVC030	2"	£32.13
H PVC035	3"	£70.27

### 0.5"

DISCOUNT CODE/ PRODUCT CODE	DESCRIPTION	PRICE EACH
H PVC105	90° Elbow P/P (A)	£0.80
H PVC110	45° Elbow P/P (B)	£1.50
H PVC115	Socket P/P (L)	£0.59
H PVC120	Socket Union P/P (C)	£3.50
H PVC125	'T' Joint P/P/P (G)	£0.91
H PVC130	End Cap (H)	£0.56
H PVC135	Barrel Nipple P/T (D)	£1.74
H PVC140	Socket Nipple P/T (M)	£1.43
H PVC990	Pipe Clip (J)	£1.41

### 0.75"

DISCOUNT CODE/ PRODUCT CODE	DESCRIPTION	PRICE EACH
H PVC205	90° Elbow P/P (A)	£0.93
H PVC210	45° Elbow P/P (B)	£1.57
H PVC215	Socket P/P (L)	£0.67
H PVC220	Socket Union P/P (C)	£3.99
H PVC225	'T' Joint P/P/P (G)	£1.16
H PVC230	End Cap (H)	£0.67
H PVC235	Barrel Nipple P/T (D)	£2.09
H PVC240	Socket Nipple P/T (M)	£1.65
H PVC991	Pipe Clip (J)	£1.67

### 1"

DISCOUNT CODE/ PRODUCT CODE	DESCRIPTION	PRICE EACH
H PVC305	90° Elbow P/P (A)	£1.30
H PVC310	45° Elbow P/P (B)	£1.93
H PVC315	Socket P/P (L)	£0.77
H PVC320	Socket Union P/P (C)	£5.17
H PVC325	'T' Joint P/P/P (G)	£1.72
H PVC330	End Cap (H)	£0.73
H PVC335	Barrel Nipple P/T (D)	£2.77
H PVC340	Socket Nipple P/T (M)	£2.59
H PVC992	Pipe Clip (J)	£1.93

### 1.25"

DISCOUNT CODE/ PRODUCT CODE	DESCRIPTION	PRICE EACH
H PVC405	90° Elbow P/P (A)	£2.27
H PVC410	45° Elbow P/P (B)	£2.77
H PVC415	Socket P/P (L)	£1.37
H PVC420	Socket Union P/P (C)	£6.45
H PVC425	'T' Joint P/P/P (G)	£2.45
H PVC430	End Cap (H)	£1.16
H PVC435	Barrel Nipple P/T (D)	£3.79
H PVC440	Socket Nipple P/T (M)	£2.52
H PVC993	Pipe Clip (J)	£2.42

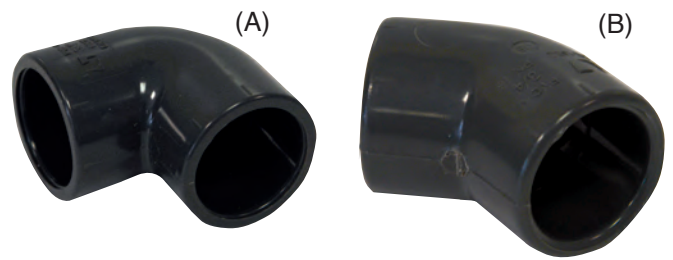

90° Elbow

45° Elbow

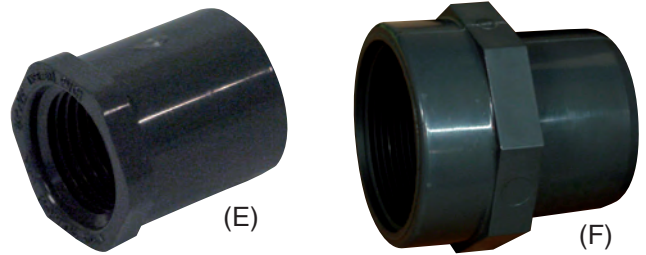

Reducing Bush P/T

Adaptor MP/FT

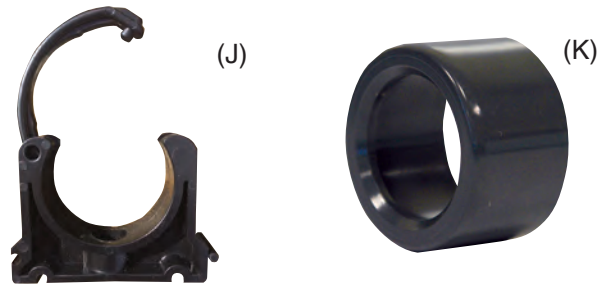

Pipe Clip

Reducing Bush P/P

### 1.5"

DISCOUNT CODE/ PRODUCT CODE	DESCRIPTION	PRICE EACH
H PVC505	90° Elbow P/P (A)	£2.93
H PVC510	45° Elbow P/P (B)	£3.47
H PVC515	Socket P/P (L)	£1.60
H PVC520	Socket Union P/P (C)	£8.81
H PVC525	'T' Joint P/P/P (G)	£3.53
H PVC530	End Cap (H)	£1.93
H PVC535	Barrel Nipple P/T (D)	£3.79
H PVC540	Socket Nipple P/T (M)	£4.55
H PVC994	Pipe Clip (J)	£2.75

### 2"

DISCOUNT CODE/ PRODUCT CODE	DESCRIPTION	PRICE EACH
H PVC605	90° Elbow P/P (A)	£4.37
H PVC610	45° Elbow P/P (B)	£4.87
H PVC615	Socket P/P (L)	£2.27
H PVC620	Socket Union P/P (C)	£11.41
H PVC625	'T' Joint P/P/P (G)	£5.60
H PVC630	End Cap (H)	£2.34
H PVC635	Barrel Nipple P/T (D)	£5.30
H PVC640	Socket Nipple P/T (M)	£6.16
H PVC995	Pipe Clip (J)	£3.49

## PVC Pipe & Fittings



Socket Union P/P

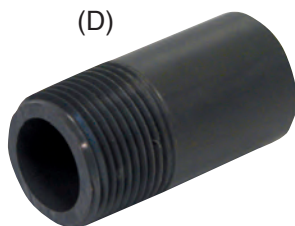

Barrel Nipple P/T



'T' Joint P/P/P

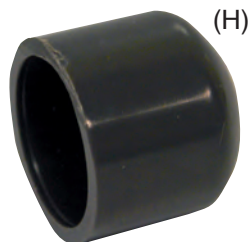

End Cap



Socket



Socket Nipple P/T

3"

DISCOUNT CODE/ PRODUCT CODE	DESCRIPTION	PRICE EACH
H PVC705	90° Elbow P/P (A)	£12.60
H PVC710	45° Elbow P/P (B)	£11.47
H PVC715	Socket P/P (L)	£8.70
H PVC720	Socket Union P/P (C)	£43.95
H PVC725	'T' Joint P/P/P (G)	£16.20
H PVC730	End Cap (H)	£7.24
H PVC735	Barrel Nipple P/T (D)	£13.86
H PVC740	3in Grey PVC Socket Nipple P T	£15.33
H PVC996	Pipe Clip (J)	£6.33

### Bushes

DISCOUNT CODE/ PRODUCT CODE	DESCRIPTION	PRICE EACH
H PVC905	0.75" to 0.5" P/P (K)	£0.68
H PVC910	1" to 0.75" P/P (K)	£0.89
H PVC915	1.25" to 1" P/P (K)	£1.18
H PVC920	1.5" to 1.25" P/P (K)	£1.42
H PVC925	1.5" to 1" P/P (K)	£1.42
H PVC930	1.5" to 0.75" P/P (K)	£1.42
H PVC935	2" to 1.5" P/P (K)	£1.96
H PVC940	3" to 2" P/P (K)	£5.60
H PVC955	0.75" Plain to 0.5" Threaded (E)	£1.93
H PVC956	1.25" Male Threaded to 0.75" Female Threaded Reducing Brush	£3.53
H PVC957	1" Plain to 0.75" Threaded (E)	£2.64
H PVC959	1.5" Male Threaded to 0.75" Female Threaded Reducing Brush	£4.37

### Male Plain to Female Thread Adaptors

DISCOUNT CODE/ PRODUCT CODE	DESCRIPTION	PRICE EACH
H PVC960	0.5" (F)	£2.37
H PVC965	0.75" (F)	£2.64
H PVC970	1" (F)	£3.26
H PVC975	1.25" (F)	£5.08
H PVC980	1.5" (F)	£5.88
H PVC985	2" (F)	£7.66

LIGHTING &  
POOL FLOW

## Pipe & Fitting Saver

- Reams old pipe material out of fittings for re-use
- Requires a drill with a 12mm size chuck

### Pipe & Fitting Saver

DISCOUNT CODE/ PRODUCT CODE	DESCRIPTION	PRICE EACH
NETT PFS-150	1.5" Fitting Saver	£88.85
NETT PFS-200	2" Fitting Saver	£90.87

**Note:** The above are nett prices



## Adhesives

LIGHTING & POOL FLOW

### Adhesives

DISCOUNT CODE/ PRODUCT CODE	DESCRIPTION	PACK SIZE	PRICE EACH
B PPF125-500	ABS & PVC Pipe Cement (500ml) Grey	20	£18.34
B PPF127-500	Pipe Cleaner (500ml)	20	£17.90
B PPF128	Clear Silicone Sealant (310ml)	12	£16.65
B PPF130	Pack of 10 PTFE Tape (12mm x 12m)	10	£9.00
B PPF132	Wet 'R' Dry Fast Cure Cement with Brush (500g)	12	£26.97
B PPF135	Wet 'R' Dry Fast Cure Cement with Brush (250g)	24	£16.99
B PPF134	Cleaning Fluid (500g)	12	£17.67

**Note:** Pack sizes shown for information purposes only



## 3-Way Valves

- Ideal for diverting flow on solar heating kits

### 3-Way Valves

DISCOUNT CODE/ PRODUCT CODE	DESCRIPTION	PRICE EACH
E MVA333	1.5"	£23.00
E TWV002	2"	£34.20

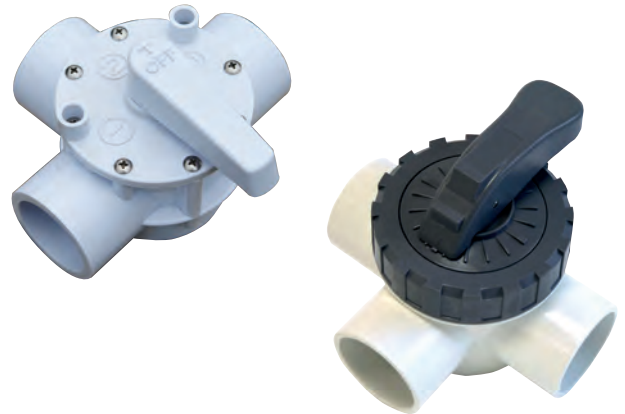

## Non-Return Valves

- These fittings are glue slip fit

### Non-Return Valves

DISCOUNT CODE/ PRODUCT CODE	DESCRIPTION	PACK SIZE	PRICE EACH
K H-RA-172288	1.5"-2" Corrosion Resistant	1	£58.00
K WCV001	Black 1.5" Serviceable Non-Return Valve	20	£54.00
K WCV002	Black 2" Serviceable Non-Return Valve	20	£54.00
K NRV015	1.5" White Serviceable Non-Return Valve	12	£42.00
K NRV020	2" White Serviceable Non-Return Valve	12	£45.00

**Note:** Pack sizes shown for information purposes only

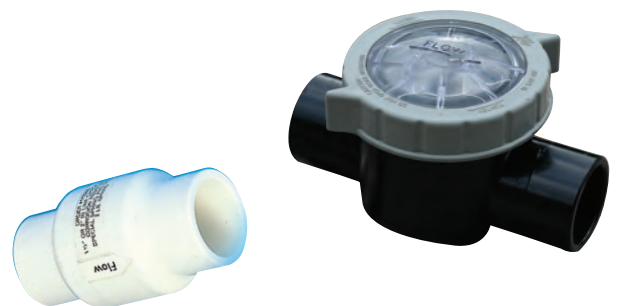

NRV015/020

# Counter Current Jet with White LED Light Kit

PALLET

LIGHTING & POOL FLOW

Perfect for small sized pools where space is limited. Also ideal for fitness training, underwater massage and endless no-lap swimming.

- Powerful counter current
- Product can be used as a single or double jet system with one or two pumps
- Counter current face plate with white LED Light
- On/Off light switch mounted on the jet face plate, easy access when you're in the water
- Adjust the valve to control the bubble effect
- Water flow can be changed through the rotating jet
- Suitable for concrete and liner pools
- Made from durable ABS structure
- For a complete installation you will need one pump, one front jet kit and a plumbing kit



## Front Jet Kit with White LED Light

DISCOUNT CODE/ PRODUCT CODE	DESCRIPTION	PRICE EACH
K CCU001K	Single Phase Kit with Control Box	£730.00

## Nadorself Pump

DISCOUNT CODE/ PRODUCT CODE	DESCRIPTION	PRICE EACH
K NCP300	Single Phase 3hp	£1,268.00

**Note:** Each kit includes a faceplate kit and electric control panel.

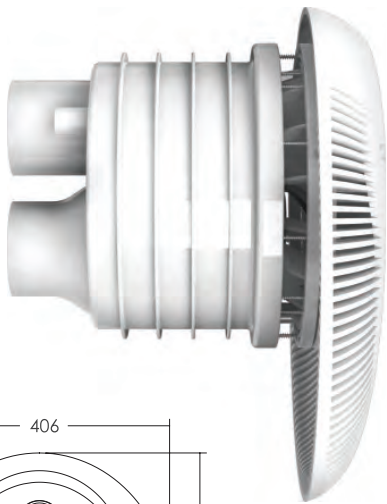

- Powerful performance
- Flow rates challenge all swimmers
- Single phase pump: 3hp (2.3kW) provides 60m³/h
- Self priming up to 4m
- Can be installed up to 3m from pool

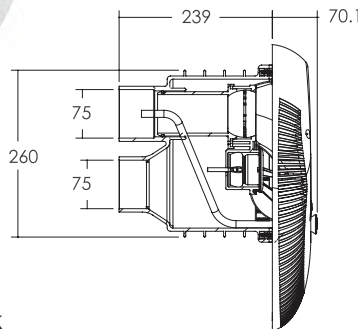
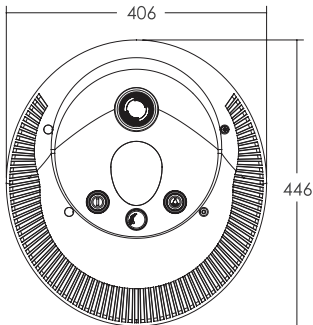

CCU001K



## Plumbing Kit

DISCOUNT CODE/ PRODUCT CODE	DESCRIPTION	PRICE EACH
K PPK006K	Plumbing Kit to suit Nadorself Pump	£219.00

**Flexible Plumbing Kit contains:**

- 2 x PPF620 75mm Socket P/FT
- 2 x PPF653 75mm Socket P/P
- 4 x PPF621 75mm-63mm reducer
- 2 x PPF622 63mm double union ball valve
- 2 x FPF633 3m 63mm Flexfit pipe
- 1 x PPF132 500g Wet R Dry



CCCB01 - 220V Counter Current Controller

## Badu Jet Smart

PALLET

LIGHTING & POOL FLOW



### Pre-Assembly Kit

DISCOUNT CODE/ PRODUCT CODE	DESCRIPTION	PRICE EACH
K BAD001	Pre-Assembly Kit	£500.00

- For all types of pool (excluding above ground)
- Delivers continuously variable flow rate up to 40m<sup>3</sup> per hour
- Massage pressure of 1.8 bar
- Air switch operation

**Note:** For a complete installation you will need one pre-assembly kit and one Final Assembly Kit.

### Final Assembly Kit

DISCOUNT CODE/ PRODUCT CODE	DESCRIPTION	PRICE EACH
K BAD002	Final Assembly Kit Single Phase 2.20kW *	£1,987.00



## Badu Jet Vogue

PALLET



### Pre-Assembly Kit

DISCOUNT CODE/ PRODUCT CODE	DESCRIPTION	PRICE EACH
K BAD001	Pre-Assembly Kit	£500.00

- Manufactured from stainless steel
- Integrated LED light
- Suitable for all pool types
- Air switch operation
- Adjustable nozzle

**Note:** For a complete installation you will need one pre-assembly kit and one Final Assembly Kit.

### Final Assembly Kit

DISCOUNT CODE/ PRODUCT CODE	DESCRIPTION	PRICE EACH
K BAD500	Final Assembly Kit Single Phase 2.20kW *	£3,494.00



# Espa Counter Current System

PALLET



LIGHTING & POOL FLOW

## Front Jet Kit

DISCOUNT CODE/ PRODUCT CODE	DESCRIPTION	PRICE EACH
K NCC001K	Single Phase Kit with Control Box	£852.00

## Nadorself Pump

DISCOUNT CODE/ PRODUCT CODE	DESCRIPTION	PRICE EACH
K NCP300	Single Phase 3hp	£1,268.00

- Directional outlet nozzle
- Adjustable water flow rate and air/water mix
- Liner and concrete pools
- Operated by air switch from inside the pool
- Use 75mm when over 3m

- Powerful performance
- Flow rates challenge all swimmers
- Single phase pump: 3hp (2.3kW) provides 60m<sup>3</sup>/h
- Self priming up to 4m
- Can be installed up to 3m from pool

**Note:** For a complete installation you will need one pump, one front jet kit and a plumbing kit.

## 63mm Metric PVC Pipe & Fittings

DISCOUNT CODE/ PRODUCT CODE	DESCRIPTION	PRICE EACH
H PPF660	Pipe per 5m Length	£62.71
H PPF656	90° Elbow P/P	£3.57
H PPF657	45° Elbow P/P	£3.99
H PPF658	Socket Union P/P	£8.50
H PPF659	Socket P/P	£1.85
H PPF622	Double Union Ballvalve	£48.25

## 75mm Metric PVC Pipe & Fittings

DISCOUNT CODE/ PRODUCT CODE	DESCRIPTION	PRICE EACH
H PPF654	Pipe per 5m Length	£89.57
H PPF650	90° Elbow P/P	£8.23
H PPF651	45° Elbow P/P	£7.67
H PPF652	Socket Union P/P	£30.25
H PPF653	Socket P/P	£4.82
H PPF655	Double Union Ballvalve	£199.68
H PPF620	Socket P/FT	£16.53
C2 FPF405/1	75mm flex pipe per metre	£15.00

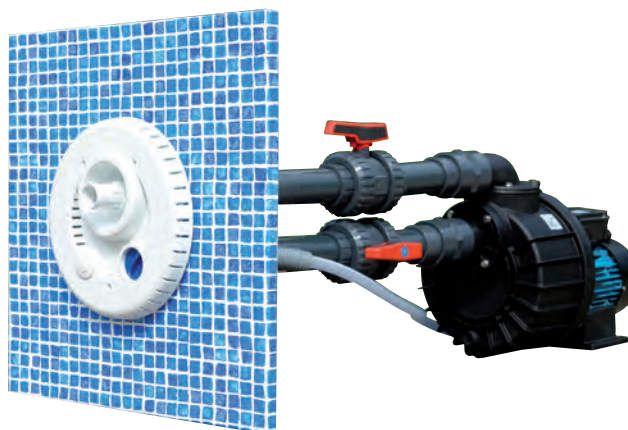

## Plumbing Kit

DISCOUNT CODE/ PRODUCT CODE	DESCRIPTION	PRICE EACH
K PPK005K	Kit	£206.00

### Flexible Pipe Plumbing Kit contains:

- PPF620 75mm Female Threaded Plain Socket x 2
- PPF621 75mm to 63mm Reducing Bushes x 2
- PPF622 63mm Double Union Ballvalve x 2
- FPF633 3m 63mm Flexfit Pipe x 2
- PPF132 500g Wet R Dry Fast Cure Cement with Brush x 1



## X-Stream Counter Current Unit

- 316 Stainless Steel
- One pneumatic air switch
- Two pump operation
- Two water jets
- Stainless Steel handrail as standard
- 2 1/2" BSP/F threaded suction



### X-Stream Counter Current Unit

DISCOUNT CODE/ PRODUCT CODE	DESCRIPTION	PRICE EACH
K XST002	X-Stream with SS grabrail per dual pump installation *	£2,545.00

### X-Stream Plumbing Kit

DISCOUNT CODE/ PRODUCT CODE	DESCRIPTION	PRICE EACH
H XST002PK	X-Stream Plumbing Kit for XST002	£454.00

#### XST021PK X-Stream Duo Plumbing Kit 63mm contains:

- PPF130S PTFE x 2
- PPF132 Wet R Dry 473ml x 1
- PPF623 Sockets Nipple P/MT x 1
- PPF621 75mm - 63mm Reducing Bush x 1
- PPF622 Double Union Ballvalves x 4
- PPF661 Equal Tee PPP x 2
- PPF659 Socket PP x 2
- PPF657 45° Elbow x 5
- PPF662 90° Short Radius Bend (swept) x 4
- 50782 63mm Wall Suction Fitting x 1
- PPF660 5m PVC Pipe x 1

### Dual Pump X-Stream Kit (Duo)

DISCOUNT CODE/ PRODUCT CODE	DESCRIPTION	PRICE EACH
K XST002K	X-Stream Kit for XST002	£4,699.00

Dual Pump X-Stream Kit contains:

- XST002
- PINCCDUO
- XST002 pk X-Stream Plumbing Kit
- WIP300 x 2 Pumps
- 100m<sup>3</sup>/h

## Counter Current Controllers

- Operate with air switch button (not supplied)
- PINCC17 - Controls 1 x 3hp pump (13.4amp)
- PINCCDUO - Controls 2 x 3hp pumps (11amp) with one press of air switch, time delay between pumps to reduce start-up current
- Compact enclosure

### Counter Current Controllers

DISCOUNT CODE/ PRODUCT CODE	DESCRIPTION	PRICE EACH
K PINCC17	⚠ Counter Current Controller (single pump 13.4 amp)	£152.00
K PINCCDUO	⚠ Counter Current Controller (dual pump 11amp)	£316.00



# ESPA Pumps



LIGHTING & POOL FLOW

- Counter current swimming in public or private swimming-pools
- Shaft in stainless steel AISI 431
- 10.000 hours P2 capacitor with aluminium casing
- 75mm threaded connections
- Mechanical seal in graphite
- Single phase with built-in thermal protection

## ESPA Nadorself

DISCOUNT CODE/ PRODUCT CODE	DESCRIPTION	PRICE EACH
K NCP300	Nadorself 300 Pump	£1,268.00

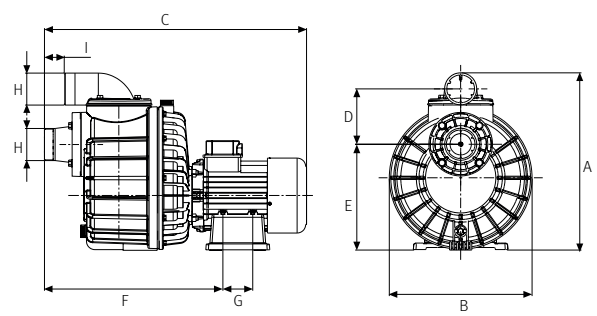
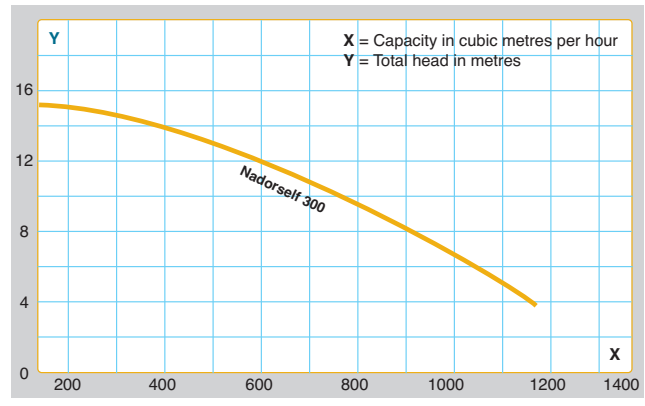

Model	A	B	C	D	E	F	G	H	I	Kg
Nadorself 300	416	335	615	130	248,5	418,5	70	2 1/2	46,5	25

- Water recirculation in spas and private pools
- Suction cover and discharge body in tecnopolymer
- Impeller and pump foot in tecnopolymer
- Mechanical seal in graphite and steatite
- 63mm suction and discharge
- Shaft in stainless steel AISI 431
- Motor housing in aluminium
- O'rings in NBR

## ESPA Wiper 3

DISCOUNT CODE/ PRODUCT CODE	DESCRIPTION	PRICE EACH
K WIP300	Wiper 3 300 Single Phase 3HP	£766.00

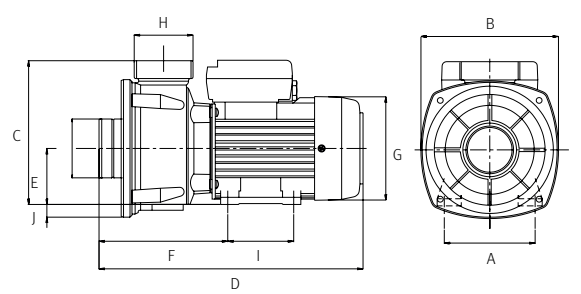
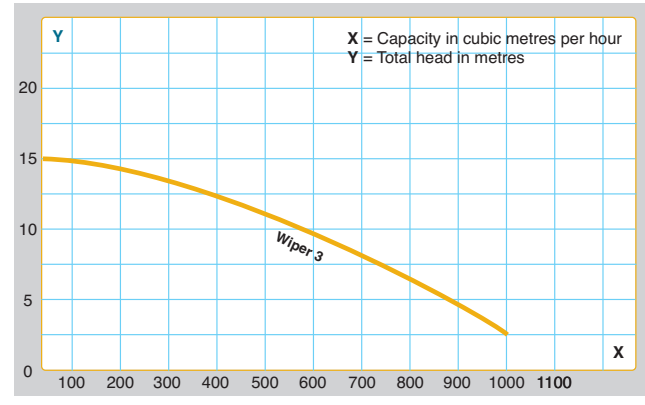

Model	A	B	C	D	E	F	G	H	I	Kg
Wiper 300	130	298,7	230	160	120	108	63	162	124	18,8

## SwimMaster™ Counter Current

PALLET



LIGHTING & POOL FLOW

The SwimMaster™ counter current unit has been specifically chosen to complement our range of Premium wooden pools, however it is not restricted to just wooden pools. The SwimMaster™ counter current unit is suitable for most conventional pool structures. Its sleek, minimalist design means it can be situated perfectly into our wooden pools but we can also supply stainless steel extensions to allow simple installation into concrete pool structures.

Coupled to the Nadorsel 3hp jet pump, this unit is capable of flowing up to 60m<sup>3</sup>/hr.

Our plumbing kit caters for a close proximity installation on our wooden pools. The kit can also be used for other applications but extra fittings may be required.

The CCU003K is a complete comprehensive kit containing 1 x CCU003 SwimMaster™ CC unit, 1 x PPK007K plumbing kit, 1 x NCP 300 Nadorsel pump and 1 x PINNC17 controller. The CCU004 Concrete kit will be required for concrete/block and liner pools.

### Plumbing kit contents

- 2 x PPF620 75mm socket P/FT
- 2 x PPF623 75mm socket nipple
- 2 x PPF664 75mm Single union ball valve
- 4 x PPF663 75mm swept 90 bend
- 1 x PPF654 75mm rigid PVC pipe
- 1 x PPF132 Wet R Dry Fast Cure Cement w brush
- 2 x PPF130S PTFE



- Simple to install
- Plumbing kit available
- 316 stainless steel construction
- Unique jet nozzle with adjustable flow
- Compact - ultra modern, yet minimalistic design
- Suitable for use with the Nadorsel 3hp jet pump

## SwimMaster™ Counter Current

DISCOUNT CODE/ PRODUCT CODE	DESCRIPTION	PRICE EACH
K CCU003K	SwimMaster™ CC Unit complete kit	£3,203.00
K CCU003	SwimMaster™ CC Unit Jet front only	£1,339.00
K CCU004	SwimMaster™ CC Concrete pool 225mm ext.	£412.00
H PPK007K	SwimMaster™ CC Plumbing Kit	£504.00
K NCP300	SwimMaster™ CC Complete kit plus Nadorsel pump	£1,268.00
K PINCC17	Counter Current Controller (single pump 13.4 amp)	£152.00

## Badu Jet

PALLET

The BADU JET range offer a powerful counter current, for endless no-turn swimming, even in the smallest pool. Thanks to the adjustable flow rate you can adapt the system to your specific needs and to the size of your pool.

Water is drawn in through the suction inlet at the bottom of the unit using a powerful pump and led back into the pool through a strong jet via an adjustable nozzle.

- Three versions available to best suit swimming ability
- Omnidirectional swivel nozzles with 60° range
- Support leg for above ground pool installations
- Adjustable flow rate system to adapt to your specific needs and to the size of your pool
- Colour changing LED ambient lighting for night exercise or an atmospheric and relaxing swim



Badu Jet Perla

Badu Jet Stella comes with two swivelling nozzles

### Badu Jet

DISCOUNT CODE/ PRODUCT CODE	DESCRIPTION	PRICE EACH
K BAD015	Perla Single Phase 1.6kW *	£2,455.00
K BAD006	Riva Single Phase 2.2kW *	£3,084.00
K BAD010	Stella Single Phase 3kW White LED	£3,525.00
K BAD012	Stella Single Phase 3kW RGB LED	£3,695.00
K BAD004	Telescopic Support Leg (777 to 1390mm)	£198.00

Badu Jet	Voltage	Power Input	Power Output	m <sup>3</sup> /h	Supply Required
Perla	230v	2300W	1.6kW	40	16a C rated fuse
Riva	230v	2900W	2.2kW	54	20a C rated fuse
Stella	230v	3000W	3kW	75	20a C rated fuse

# Liners

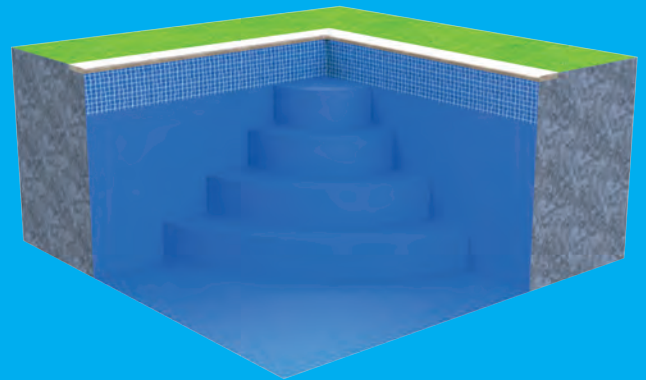
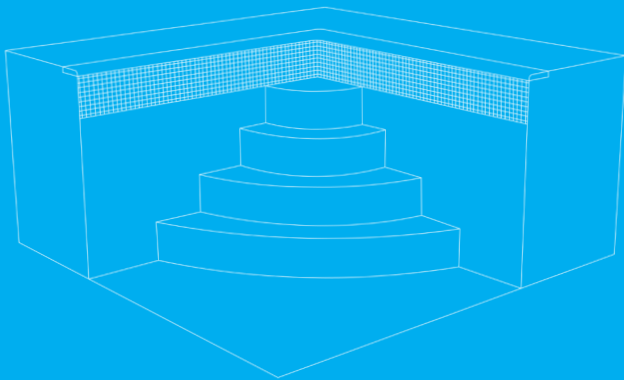



## Domestic Liners

- 5 year pro rata warranty on all 20 thou and 30 thou liners
- Material is impregnated with algicide
- Material samples available
- Each liner is now supplied with a serial number for hassle free replacement



Points common to all liners:

- Ensure the pool structure is compatible with being in contact with PVC materials.
- 29°C maximum pool water temperature.
- Do not install in air temperatures of less than 10°C as the material will become stiff and difficult to fit evenly.
- Due to the material being flexible during the printing and cutting processes, patterns cannot be made to match along the weld lines or cut edges.
- Issues with the aesthetic finish are not accepted as a warranty issue.
- Occasional vertical weld joints in the wall are unavoidable and placed at our discretion unless instructed at time of order.
- Patterned materials may show a thin white line along the weld edge. This is due to the white base material flowing during the weld process and is a normal part of a good weld (this is not accepted as a warranty issue).
- Liner colours shown in print may vary slightly from materials received.
- Every effort is made to match patterned material colours but these naturally vary, even within the same batch.
- Liners requiring complex drawing or manufacturing may be subject to additional lead time.

### Coloured Beading:

Plastica offer a selection of different colour beading other than white to suit the pool surroundings and/or the liner colour. Also available is Adriatic Blue, Green, Light Blue, Grey and Black. Please enquire when placing your order if you require a specific colour of bead. As standard, Plastica will fit the colour that best matches the particular colour/pattern liner.

**Note:** The Kafko Posilock beading that Plastica stock is only available in Adriatic Blue.



## Domestic Liners

The following prices are a guide for rectangular hopper/wedge liners with a 3'4" wall height

### Plain - 20 thou (0.5mm)

DISCOUNT CODE/ PRODUCT CODE	DESCRIPTION
A	▲ 10' x 20' (43m <sup>2</sup> )
A	▲ 12' x 24' (57m <sup>2</sup> )
A	▲ 14' x 28' (73m <sup>2</sup> )
A	▲ 14' x 30' (78m <sup>2</sup> )
A	▲ 15' x 30' (82m <sup>2</sup> )
A	▲ 16' x 32' (92m <sup>2</sup> )
A	▲ 16' x 38' (107m <sup>2</sup> )
A	▲ 18' x 36' (112m <sup>2</sup> )
A	▲ 20' x 40' (134m <sup>2</sup> )

### Plain - 30 thou (0.75mm)

DISCOUNT CODE/ PRODUCT CODE	DESCRIPTION
A	▲ 10' x 20' (43m <sup>2</sup> )
A	▲ 12' x 24' (57m <sup>2</sup> )
A	▲ 14' x 28' (73m <sup>2</sup> )
A	▲ 14' x 30' (78m <sup>2</sup> )
A	▲ 15' x 30' (82m <sup>2</sup> )
A	▲ 16' x 32' (92m <sup>2</sup> )
A	▲ 16' x 38' (107m <sup>2</sup> )
A	▲ 18' x 36' (112m <sup>2</sup> )
A	▲ 20' x 40' (134m <sup>2</sup> )

### Patterned - 20 (0.5mm)

DISCOUNT CODE/ PRODUCT CODE	DESCRIPTION
A	▲ 10' x 20' (43m <sup>2</sup> )
A	▲ 12' x 24' (57m <sup>2</sup> )
A	▲ 14' x 28' (73m <sup>2</sup> )
A	▲ 14' x 30' (78m <sup>2</sup> )
A	▲ 15' x 30' (82m <sup>2</sup> )
A	▲ 16' x 32' (92m <sup>2</sup> )
A	▲ 16' x 38' (107m <sup>2</sup> )
A	▲ 18' x 36' (112m <sup>2</sup> )
A	▲ 20' x 40' (134m <sup>2</sup> )

### Patterned - 30 thou (0.75mm)

DISCOUNT CODE/ PRODUCT CODE	DESCRIPTION
A	▲ 10' x 20' (43m <sup>2</sup> )
A	▲ 12' x 24' (57m <sup>2</sup> )
A	▲ 14' x 28' (73m <sup>2</sup> )
A	▲ 14' x 30' (78m <sup>2</sup> )
A	▲ 15' x 30' (82m <sup>2</sup> )
A	▲ 16' x 32' (92m <sup>2</sup> )
A	▲ 16' x 38' (107m <sup>2</sup> )
A	▲ 18' x 36' (112m <sup>2</sup> )
A	▲ 20' x 40' (134m <sup>2</sup> )

### Plain with Tileband - 20 thou (0.5mm)

DISCOUNT CODE/ PRODUCT CODE	DESCRIPTION
A	▲ 10' x 20' (43m <sup>2</sup> )
A	▲ 12' x 24' (57m <sup>2</sup> )
A	▲ 14' x 28' (73m <sup>2</sup> )
A	▲ 14' x 30' (78m <sup>2</sup> )
A	▲ 15' x 30' (82m <sup>2</sup> )
A	▲ 16' x 32' (92m <sup>2</sup> )
A	▲ 16' x 38' (107m <sup>2</sup> )
A	▲ 18' x 36' (112m <sup>2</sup> )
A	▲ 20' x 40' (134m <sup>2</sup> )



LINERS

### Plain with Tileband - 30 thou (0.75mm)

DISCOUNT CODE/ PRODUCT CODE	DESCRIPTION
A	▲ 10' x 20' (43m <sup>2</sup> )
A	▲ 12' x 24' (57m <sup>2</sup> )
A	▲ 14' x 28' (73m <sup>2</sup> )
A	▲ 14' x 30' (78m <sup>2</sup> )
A	▲ 15' x 30' (82m <sup>2</sup> )
A	▲ 16' x 32' (92m <sup>2</sup> )
A	▲ 16' x 38' (107m <sup>2</sup> )
A	▲ 18' x 36' (112m <sup>2</sup> )
A	▲ 20' x 40' (134m <sup>2</sup> )

### Combination - 20 thou (0.5mm)

DISCOUNT CODE/ PRODUCT CODE	DESCRIPTION
A	▲ 10' x 20' (43m <sup>2</sup> )
A	▲ 12' x 24' (57m <sup>2</sup> )
A	▲ 14' x 28' (73m <sup>2</sup> )
A	▲ 14' x 30' (78m <sup>2</sup> )
A	▲ 15' x 30' (82m <sup>2</sup> )
A	▲ 16' x 32' (92m <sup>2</sup> )
A	▲ 16' x 38' (107m <sup>2</sup> )
A	▲ 18' x 36' (112m <sup>2</sup> )
A	▲ 20' x 40' (134m <sup>2</sup> )

### Combination - 30 thou (0.75mm)

DISCOUNT CODE/ PRODUCT CODE	DESCRIPTION
A	▲ 10' x 20' (43m <sup>2</sup> )
A	▲ 12' x 24' (57m <sup>2</sup> )
A	▲ 14' x 28' (73m <sup>2</sup> )
A	▲ 14' x 30' (78m <sup>2</sup> )
A	▲ 15' x 30' (82m <sup>2</sup> )
A	▲ 16' x 32' (92m <sup>2</sup> )
A	▲ 16' x 38' (107m <sup>2</sup> )
A	▲ 18' x 36' (112m <sup>2</sup> )
A	▲ 20' x 40' (134m <sup>2</sup> )

**Note:** Combination Liners have patterned floor, plain wall & mosaic tileband.  
Liners 40sqm and over incur a flat rate delivery charge per liner, see page 4 for rates.

## Patterned Liner Materials

LINERS

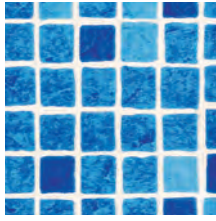

Persia Blue

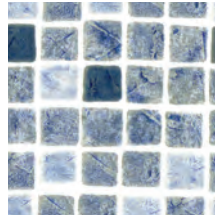

Persia Grey

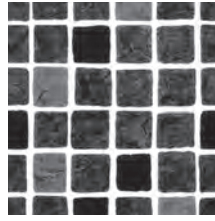

Persia Grey-Black

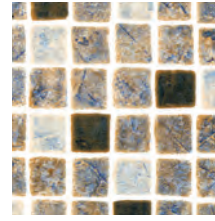

Persia Sand



Byzance

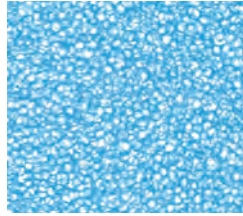

Gemstone Light Blue

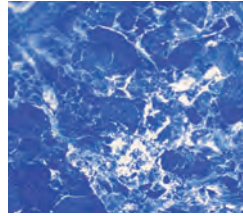

Classic Marble

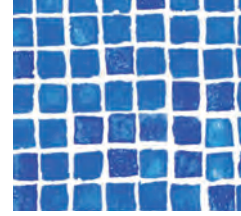

Mosaic Tile (30 Thou)

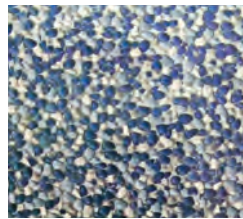

Fine Lapis ★★★

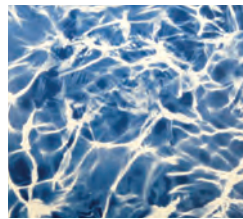

Diffusion ★★★

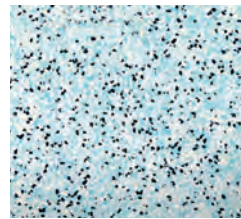

Terrazzo ★★★

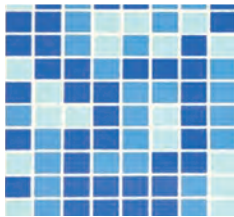

● Portofino ★★★

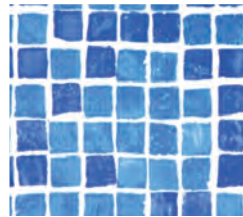

● Sanremo ★★★



● Elba ★★★



● Amalfi ★★★



Adriatic Blue ★★



● Sanremo ★★★

★ Only available while stocks last    ★★ Also available in 0.5mm (20thou)    ★★★ Exclusive to Plastica    ● New to Plastica

**Note:** Colours may vary between material gauges. If in doubt, phone Customer Services for an up-to-date sample.

## Non-Slip Liner

1mm Anti Slip Material for step treads, Diving Blocks and Shallow areas of the pool. The material conforms to the European Standard EN 13451 -1 and achieves the highest safety classification (Class C) for slip resistance.

Two colours available



White



Adriatic Blue

**Please note:** colours may vary between material gauges. If in doubt, phone Customer Services for an up-to-date sample.

## Liner Tilebands

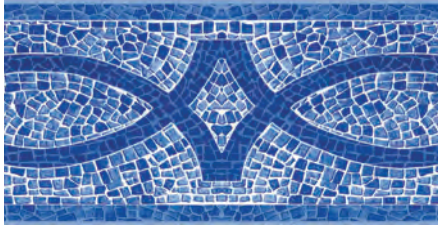

Lisboa Blue ★



Balmoral ★ £

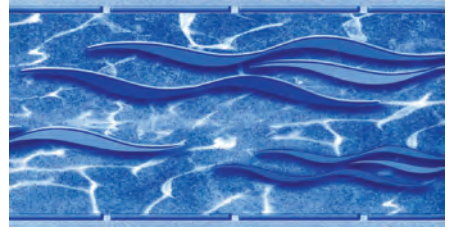

Ibiza Blue ★



Pompei Blue ★



Pompei Plus Grey-Blue ★



Carthage Blue ★

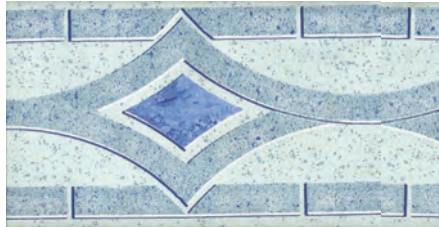

Mallorca Blue ★



Mykonos Blue ★

★ Only available while stocks last    ★★ Also available in 0.5mm (20thou)    £ Special price available



LINERS

## Plain Liner Materials

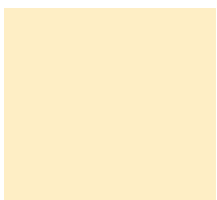

Sand

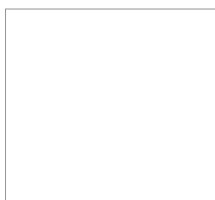

White

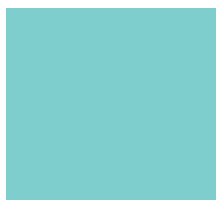

Green



Grey

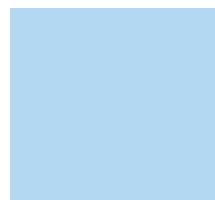

Light Blue

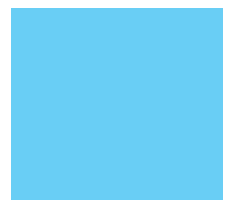

Adriatic Blue ★★

## Bespoke Domestic Liners

LINERS



### 0.5mm (20 thou)

DISCOUNT CODE/ PRODUCT CODE	DESCRIPTION	PRICE EACH
A PLI210	▲ Plain m <sup>2</sup>	£25.10
A PLI220	▲ With Tileband m <sup>2</sup> *	£27.60
A PLI230	▲ Patterned m <sup>2</sup>	£32.30
A PLI240	▲ Combination m <sup>2</sup>	£31.30

\* **Note:** all 20 thou liners will come with a 30 thou tileband

### 0.75mm (30 thou)

DISCOUNT CODE/ PRODUCT CODE	DESCRIPTION	PRICE EACH
A PLI310	▲ Plain m <sup>2</sup>	£36.55
A PLI320	▲ Plain & Tileband m <sup>2</sup>	£42.40
A PLI330	▲ Patterned m <sup>2</sup>	£50.90
A PLI340	▲ Combination m <sup>2</sup>	£47.95

### Liner Surcharges

DISCOUNT CODE/ PRODUCT CODE	DESCRIPTION	PRICE EACH
MINIHFSW	Surcharge for Liner Under 40m <sup>2</sup>	£211.23

**Note:** Prices are per chargeable metre.  
Refer to page 51 for details of how to calculate this.



### Unique Serial Numbers

All liners are now embossed with a serial number along with the Plastica logo which easily identifies that it is a Plastica liner. This will be situated in the centre of the width just below the beading on deep end walls unless an alternative position is requested in writing at time of order. Please quote this number to customer services when ordering a replacement liner for this pool and we will have the exact dimensions.

## Motifs

- Dolphin design or your own bespoke motif
- Cut out of plain vinyl and welded to liner
- Individualise your pool

**Note:** When ordering motifs please give a diagram with precise dimensions and location on liner.

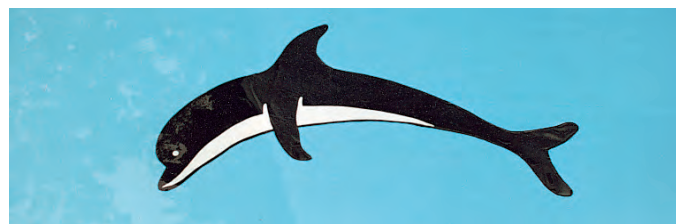

### Motifs

DISCOUNT CODE/ PRODUCT CODE	DESCRIPTION	PRICE EACH
A PLI600S	▲ Dolphin Motif Standard 7' Length	£493.00
A PLI602S	▲ Dolphin Motif Standard 4' Length	£448.00

**Note:** Liners 40sqm and over incur a flat rate delivery charge per liner, see page 4 for rates.



# Bespoke Liner Calculation

- Liners are priced per chargeable metre and calculated as below
- Dimensions are converted to the nearest square metre for invoicing purposes
- 0.5mm (20 thou) or 0.75mm (30 thou) thickness available
- Wall heights should include 150mm for overlap if required

- Quotes should be obtained for irregularly shaped or pools under 40m<sup>2</sup> as these can incur surcharges
- Small liners charged at flat sheet price (plus surcharge of £211.23)
- Complex liners may require up to 5 days extra lead time.
- Complicated liners and those with small detailed areas can be prone to small tension lines or creases

INCHES	1"	2"	3"	4"	5"	6"	7"	8"	9"	10"	11"
FEET	0.083	0.167	0.25	0.333	0.417	0.5	0.583	0.667	0.75	0.833	0.917

These figures are a guide on shaped pools. See the following for irregular shaped pools.

## Rectangular constant depth type liners

Surface area of floor = length x width  
 Surface area of wall = perimeter x wall height  
 Example: Pool size 16' x 32' with constant depth of 4' 6"  
 Surface area of floor = 16' x 32' = 512ft<sup>2</sup>  
 Surface area of wall = (16' + 32') x 2 x 4.50 = 432ft<sup>2</sup>  
 Total surface area = 944 x 0.0929 = 88m<sup>2</sup>

## Shaped walled type liners

Surface area of floor = length x width.  
 Surface area of wall = perimeter x maximum depth  
 Example: Pool size 16' x 32' with maximum depth of 7'  
 Surface area of floor = 16' x 32' = 512ft<sup>2</sup>  
 Surface area of wall = (16' + 32') x 2 x 7 = 672ft<sup>2</sup>  
 Total surface area = 512 + 672 = 1184 ft<sup>2</sup> x 0.0929 = 110m<sup>2</sup>  
 Note: Maximum wall height is used as the factor in calculating surface area of wall.

## Hopper and Wedge type Liners including constant depth pools with wall-to-floor reveal

Surface area of floor = length x width x 1.3\*  
 Surface area of wall = perimeter x wall height  
 Example: Pool size 16' x 32' with a wall height of 3' 4"  
 Surface area of floor = 16' x 32' x 1.3 = 665.6ft<sup>2</sup>  
 Surface area of wall = 96 x 3.333 = 319.97  
 Total area = 985.57 x 0.0929 = 92m<sup>2</sup>  
 \*1.6 to calculate for oval type liners.  
 1.7 to calculate for kidney type liners.  
 2.25 to calculate for dished and kidney Capri type liners.

## Round constant depth type liners

Surface area of floor = the diameter of the pool squared  
 Surface area of wall = (3.14 x diameter) x height of wall  
 Example: Pool diameter 20' x 4' wall height  
 Surface area of floor = 20' x 20' = 400ft<sup>2</sup>  
 Surface area of wall = (3.14 x 20') x 4' = 251.2ft<sup>2</sup>  
 Total surface area = 400 + 251.2 = 651.2 x 0.0929 = 60m<sup>2</sup>

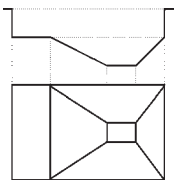

HOPPER

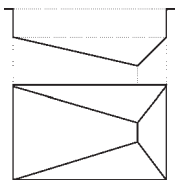

WEDGE

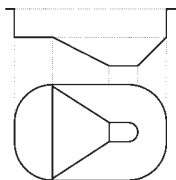

OVAL HOPPER

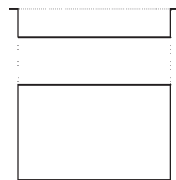

CONSTANT DEPTH

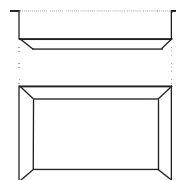

CONSTANT DEPTH with REVEALS

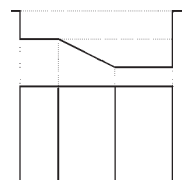

SHAPED WALL

# Surveys for Complicated Liners

We offer a Surveying Service for complicated pool shapes – see page 6 for details.

**Note:** Pools being surveyed for domestic liners must have the old liner completely removed and be empty of water to allow the Surveyor good access or a rescheduled visit and extra costs will be incurred.



## Bespoke Domestic Liner Step Options

Built in walk-in-stairs and bays of any size can be fully lined as an integrated part of the main liner. With careful measuring and attention to detail when fitting, old concrete or even fibreglass stairs can have the vinyl liner tailored to fit their shape making them perfectly waterproof again at the fraction of the price.

- Non-slip material available in Adriatic Blue and White
- Conforms to Class C slip resistance classification the highest European Standard
- Aesthetically pleasing and safer to use
- 15cm (6") water depth covering the top step is essential to minimise liner slip and creasing

If you are unsure about the careful surveying required for the steps to be lined, please call our Liner Department in the Production Office.

1mm Anti Slip Material for step treads, Diving Blocks and Shallow areas of the pool. The material conforms to the European Standard EN 13451 -1 and achieves the highest safety classification (Class C) for slip resistance.

These sketches give an idea of the selection of step designs that are possible. Step edges should be finished with a very small "pencil" radius to prevent sharp edges and sand bags or other ballast should be used during filling to help keep the liner in position.

### Bespoke Domestic Liner Step Options

DISCOUNT CODE/ PRODUCT CODE	DESCRIPTION	PRICE EACH
STEPS1	▲ Internal Straight Corner Steps (1)	£395.00
STEPS2	▲ Internal Curved Corner Steps (2)	£430.00
STEPS3	▲ External Straight Steps (3)	£450.00
STEPS4	▲ External Roman Steps (4)	£475.00
STEPS5	▲ Full Width Steps (5)	£475.00
STEPS6	▲ Inside Steps (6)	£450.00
PITHFWS	▲ Liner with Reel Pit (7)	£404.00

The above prices are NETT.

1

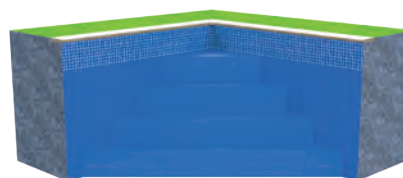

2

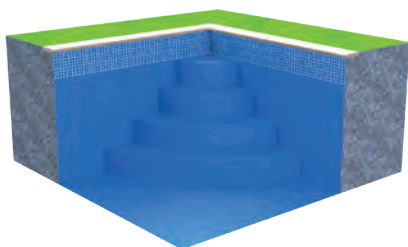

3



4

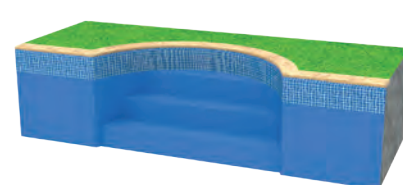

5

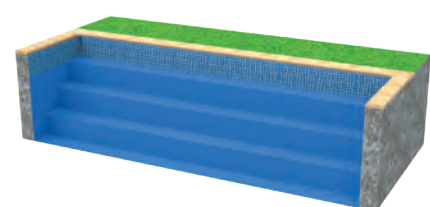

6



7



## Non-Slip Liner

1mm Anti Slip Material for step treads, Diving Blocks and Shallow areas of the pool. The material conforms to the European Standard EN 13451 -1 and achieves the highest safety classification (Class C) for slip resistance.

Two colours available

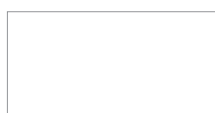

White



Adriatic Blue

**Please note:** colours may vary between material gauges. If in doubt, phone Customer Services for an up-to-date sample.

## EPS Easy Build In-pool Corner Steps

PALLET HEAVY MADE TO ORDER

Made from a 25kg/m<sup>3</sup> density EPS block which is covered in shaped non-corrosive Magnelis steel sheeting, the units are lightweight and easy to handle. No concreting or rendering is needed, and with adhesives included and no specialist tools required the build time is approximately one hour.

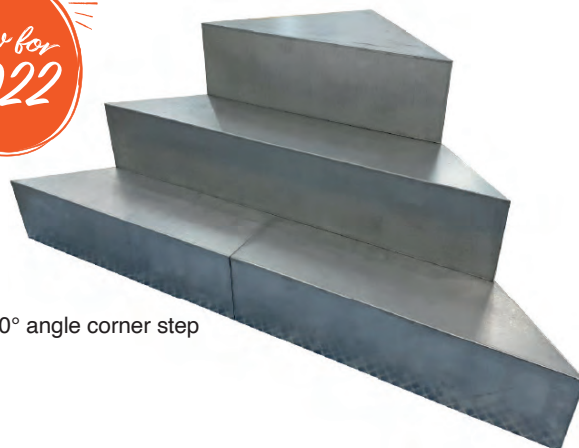

90° angle corner step

- Quick and easy to assemble – 1hour approximate build time
- No concreting or rendering required
- No specialist tools needed
- Includes the required contact adhesive and liner protection tape
- Lightweight and easy to handle
- Delivered on a single pallet
- Suitable for factory made and site applied vinyl linings
- 4 different size options available
- All sizes of step are suitable for 90° and 6" radius corner pools

### Specifications

25kg/m<sup>3</sup> EPS step body with 2mm cut and shaped, non-corrosive, Magnelis steel covering.

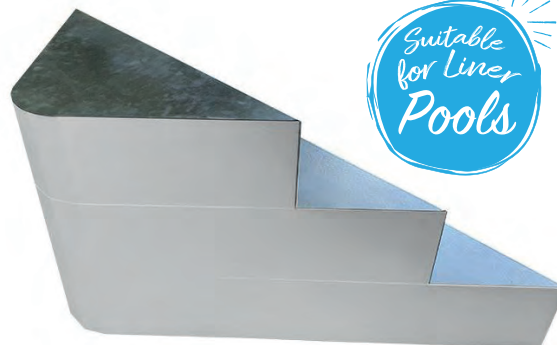

6" radius corner step

**Note:** Please do not order a liner to suit these steps until you have fitted the unit securely in place and have checked the overall dimensions, this will ensure the best fit of the liner.

### EPS Easy Build In-pool Corner Steps

DISCOUNT CODE/ PRODUCT CODE	DESCRIPTION	PRICE EACH
D ECS1386720	⊗ ▲ EPS Corner Steps 1386 X 720 90°	£1,276.00
D ECS1386720R	⊗ ▲ EPS Corner Steps 1386 X 720 6" Radius corner	£1,276.00
D ECS15751200	⊗ ▲ EPS Corner Steps 1575 X 1200 90°	£2,255.00
D ECS15751200R	⊗ ▲ EPS Corner Steps 1575 X 1200 6" Radius corner	£2,255.00
D ECS1575900	⊗ ▲ EPS Corner Steps 1575 X 900 90°	£1,727.00
D ECS1575900R	⊗ ▲ EPS Corner Step 1575 X 900 6" Radius corner	£1,727.00
D ECS20001200	⊗ ▲ EPS Corner Step 2000 X 1200 90°	£2,431.00
D ECS20001200R	⊗ ▲ EPS Corner Step 2000 X 1200 6" Radius corner	£2,431.00

## Black Pond Liners

MADE TO ORDER



- 0.5mm (20 thou) – weighs 0.63kg per sq.m.
- Strong black vinyl

### Black Pond Liners

DISCOUNT CODE/ PRODUCT CODE	DESCRIPTION	PRICE EACH
A2 PLP200	⊗ ▲ Flat Sheet 0.5mm (20 thou) per m <sup>2</sup>	£13.57
A2 PLP210	⊗ ▲ Bespoke 0.5mm (20 thou) per m <sup>2</sup>	£15.62



**Note:** For sheets over 40m<sup>2</sup> obtain a written quotation.

**Note:** Liners 40m<sup>2</sup> and over incur a flat rate delivery charge per liner, see page 4 for rates.

LINERS



## Linerlock Corner

- For rounded corners between 140mm-165mm radius
- Secure using a minimum of four fixings spaced at approx 90mm

### Corner

DISCOUNT CODE/ PRODUCT CODE	DESCRIPTION	PRICE EACH
A PLL075	Corner	£4.71

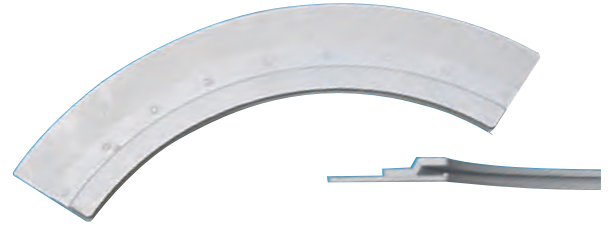

LINERS

## Top Mount Linerlock



- High impact PVC cut into 3m lengths
- Compatible with most beaded liners
- Top mount Linerlock (51mm)
- Multicut Corner (500mm x 51mm)

### Top Mount

DISCOUNT CODE/ PRODUCT CODE	DESCRIPTION	PRICE EACH
A PLL101	3m Length of 2"	£15.74
A PLL230	Multicut 6" Radius Corner	£9.30



Multicut Corner

**Note:** Ensure the Linerlock is fully supported where applicable and not compressed by coping stones.

Fixings for Linerlock should be between 20cm and 30cm apart.

See page 56 for fixings.

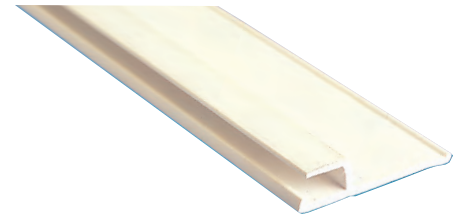

Top Mount Linerlock

## Side Mount Linerlock



- Fixings should be spaced at approx 150mm (depending on strength of wall)

### Side Mount

DISCOUNT CODE/ PRODUCT CODE	DESCRIPTION	PRICE EACH
A LLO201	3m Length	£20.01

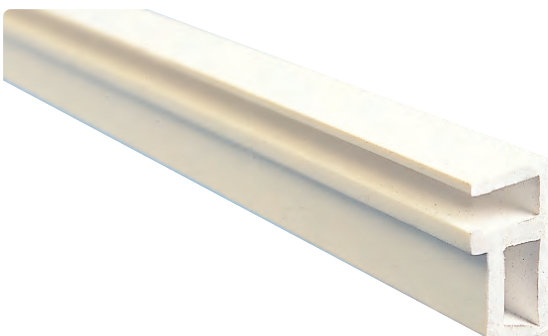

NUMBER OF 3M LENGTHS	MAXIMUM POOL PERIMETER WITH SQUARE CORNERS	COMPATIBLE POOLS (Square Corners)
6	18m (59')	3m x 6m
7	21m (68'6")	10' x 20'
8	24m (78'6")	4m x 8m - 12' x 24'
9	27m (88'6")	4.5m x 7m - 14' x 28'
10	30m (98')	5m x 10m 15' x 30' - 16' x 32'
11	33m (108')	16' x 38' - 18' x 36'
12	36m (118')	6m x 12m
13	39m (127'6")	20' x 40'



## Corner Inserts

- Preformed radius corner 150mm

### Corner Inserts (4 pack)

DISCOUNT CODE/ PRODUCT CODE	DESCRIPTION	PRICE EACH
NETT PCI400	⚙️ ▲ 1.07m	£60.06
NETT PCI450	⚙️ ▲ 1.5m	£73.16

The above prices are NETT.



## Underlay

BULKY

- 4mm thick Felt
- 2m width
- 50m<sup>2</sup>
- For floors
- One 25m roll covers a 4m x 8m floor
- 8mm foam (56m<sup>2</sup>)
- 1.00m width Dark Grey
- 1.5m width (75m<sup>2</sup>) Natural
- For walls

### Felt

DISCOUNT CODE/ PRODUCT CODE	DESCRIPTION	PRICE EACH
B FEL025	⚙️ ▲ 25m Roll	£414.00

Use the chart below to estimate rolls – Add 10% for wastage

STANDARD HOPPER	FLOOR AREA M <sup>2</sup>	WALL AREA M <sup>2</sup>
10' x 20'	24.2	18.6
12' x 24'	34.8	22.3
14' x 28'	47.3	26.0
14' x 30'	50.7	27.2
15' x 30'	54.3	27.9
16' x 32'	61.8	29.7
16' x 38'	73.4	33.4
18' x 36'	78.3	33.4
20' x 40'	96.6	37.2

### Foam

DISCOUNT CODE/ PRODUCT CODE	DESCRIPTION	PRICE EACH
B FOA093DG	⚙️ ▲ 56m x 1.00m Roll	£545.00
B FOA091	⚙️ ▲ 50m x 1.50m Roll	£697.00

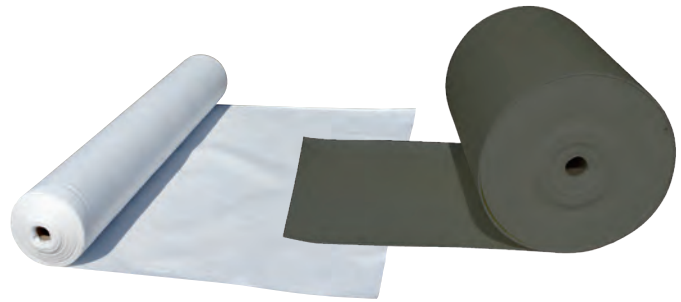

Foam underlay is not recommended in high water table areas.

## Liner Adhesives & Repair

### Adhesives

DISCOUNT CODE/ PRODUCT CODE	DESCRIPTION	SUITABLE FOR	PRICE EACH
NETT GLU001	⚙️ Thixotropic Glue (5 litre)	Felt & Foam Underlay	£59.27
NETT TAP003	⚙️ Filament Tape 50mm x 50m	Felt & Foam Underlay	£11.90
NETT ADH002	⚙️ Box of 12 x 500ml Spray Adhesive	Felt & Foam Underlay	£54.50
NETT PLR210	⚙️ Professional PVC Adhesive (1 litre)	Liners	£44.05

### Repair

DISCOUNT CODE/ PRODUCT CODE	DESCRIPTION	SUITABLE FOR	PRICE EACH
NETT LRK102	⚙️ Repair Kit (2oz)	Liner Repair	£5.60
NETT ZAP380	⚙️ Self Adhesive Patch Kit	Liner Repair	£3.50

**Note:** LRK102 can be used underwater.

The above prices are NETT



Thixotropic Glue – GLU001



## Linerlock "Cover Up" Wedge

- Covers up grout/cement between coping and linerlock
- White or stone colour
- UV stabilised
- Box of 25 contains enough to cover up approx three average domestic pools

### "Cover Up" Wedge

DISCOUNT CODE/ PRODUCT CODE	DESCRIPTION	PRICE EACH
NETT LBW003	Box of 25 x 3m Stone	£73.50
NETT LBW004	Box of 25 x 3m White	£73.50

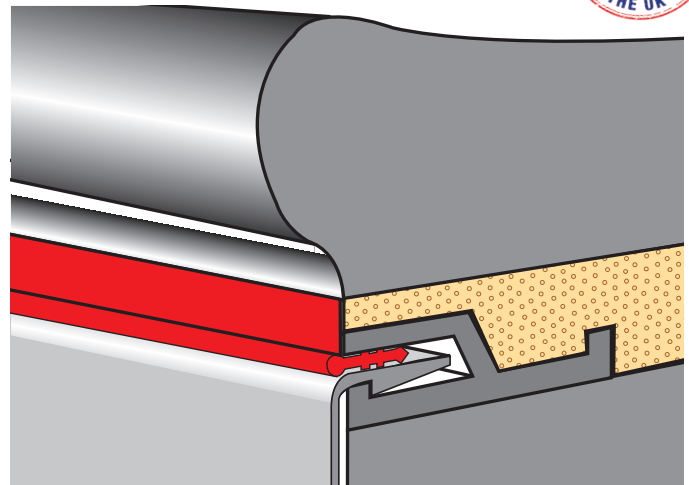
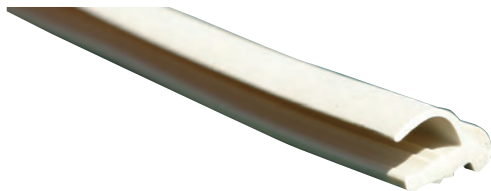

LINERS

## Linerlock Wedge



- Holds liner beading in place
- Tidy finish
- Keeps stone and grout out of Linerlock
- UV stabilised

### Wedge

DISCOUNT CODE/ PRODUCT CODE	DESCRIPTION	PRICE EACH
NETT LBW001	50m Roll	£46.00

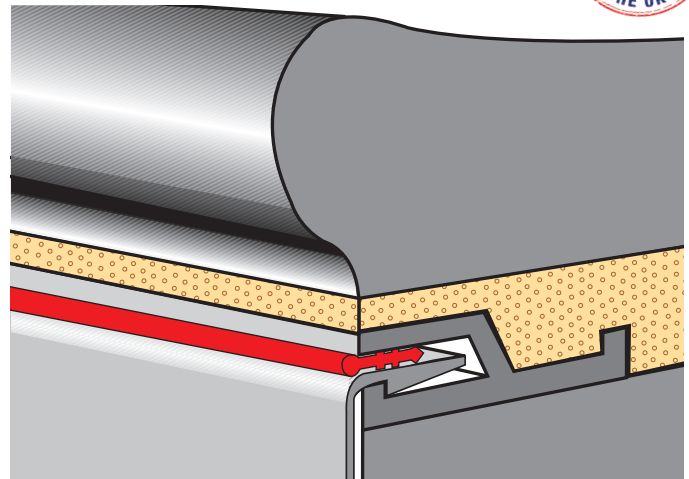

## Linerlock Fixings

### Linerlock Screws (pack of 100)

DISCOUNT CODE/ PRODUCT CODE	DESCRIPTION	PRICE EACH
NETT PLL515	⊗ No. 10 x 1"	£20.40
NETT PLL560	⊗ No. 8 x 1" for Wideback Linerlock	£9.50
NETT PLL510	⊗ No. 10 x 2" for Slide Mount Linerlock	£17.70

### Linerlock Fixings (pack of 100)

DISCOUNT CODE/ PRODUCT CODE	DESCRIPTION	PRICE EACH
NETT PLL530	⊗ Masonry Nails (25mm) for Wideback Linerlock	£8.80
NETT PLL540	⊗ No. 10 x 5/8" Hex Headed Self Drilling Screws	£10.70
NETT PLL550	⊗ 23.5mm x 4.8mm Drive Rivets - 5mm drill	£26.50

**Note:** Fixing prices shown are nett – no discount is applicable



Liner Screws – PLL560



Linerlock Fixings – PLL530



Linerlock Fixings – PLL540



Linerlock Fixings – PLL550

**Note:** All screws are stainless and self tapping.

The above prices are NETT

# Extreme® Pool Lining

SPECIAL ORDER

On-Site  
Lining Since  
**1988**

Ideal for:

- Schools
- Domestic Pools
- Hotels
- Holiday Camps
- Health Clubs
- Hydrotherapy Pools
- Deck Level Pools

Moormead Leisure

## EXTREME® POOL LINING SYSTEM

LINERS

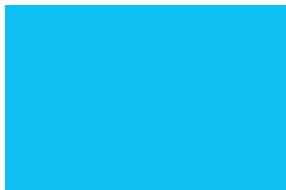

Mid Blue

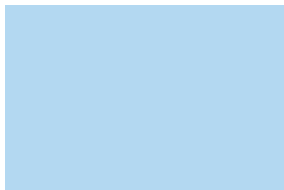

Ice Blue



Sand



White \*



Dark Grey \*



Aqua \*

- Flexible membrane, will not crack
- Unaffected by frost and ice
- No drying or curing time
- Linerlock or Profile fitting
- No need to lift copings
- All seams overlapped, tested & sealed
- Easy to clean and maintain
- Stain, abrasion and scratch resistant
- Ideal for renovating old leaking pools
- Perfect for complex shapes & designs
- Non-slip available for steps
- Racing lanes and motifs available

\* Special Order

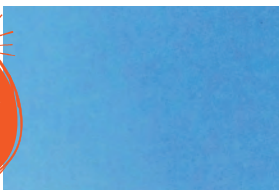

Azure

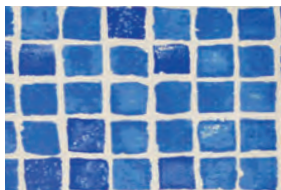

Malmoa

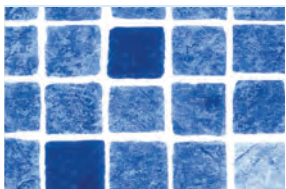

Persia Blue

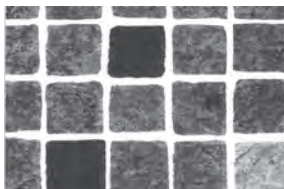

Persia Black \*

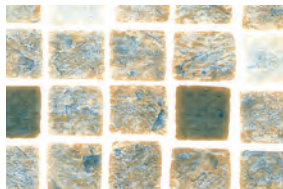

Persia Sand

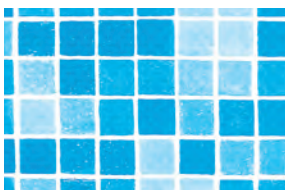

Byzance

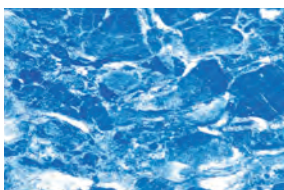

Marble

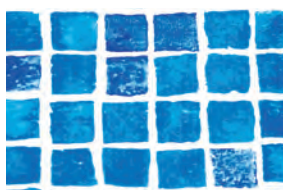

Mosaic

In addition to our In-House installation service, we now offer a material supply only. Please contact us for a competitive quotation at [pat@plasticpools.net](mailto:pat@plasticpools.net)

**Note:** colours may vary between material batches and look slightly different in our price list. For an accurate guide, contact Pat Devaney for a sample swatch and more information about the Extreme® Pool Lining System on 01424 857741 or email: [pat@plasticpools.net](mailto:pat@plasticpools.net)

## Extreme® Pool Lining

SPECIAL  
ORDER

LINERS

- 1.5mm thick with reinforcing
- Excellent UV stability
- Non slip available for steps & shallow areas  
(7 plain colours available)
- Tough, hard wearing and flexible
- Cut and tailored on site to suit the contours of the pool
- Cost effective and proven system for lining both  
new and existing pools
- Guaranteed for 10 years
- Stain, abrasion and scratch resistant  
lacquered top coating
- Perfect for complex shapes and designs
- No drying or curing time
- Easy to clean and maintain
- All seams overlapped, hot air welded and tested
- Can be run at temperatures up to 32°C
- Hydrotherapy pools up to 35°C  
(guarantee reduced to 5 years)
- Normal domestic pool typically completed in 3- 4 days
- Can be installed at any time of the year

**EXTREME®** is a registered trademark of Plastica Limited

Top: Persia Blue  
Middle: Persia Sand  
Bottom: Blue Marble



On-Site  
Lining Since  
**1988**



**Note:** colours may vary between material batches and look slightly different in our price list. For an accurate guide, contact Pat Devaney for a sample swatch and more information about the Extreme® Pool Lining System on 01424 857741 or email: [pat@plasticapools.net](mailto:pat@plasticapools.net)

# Extreme® Ceramic Look Liner

SPECIAL ORDER

The Ceramic range of reinforced pool linings has the look and appearance of traditional Ceramic tiles. In order to achieve the stunning effect the material is thicker than the traditional range of Extreme® materials. The Ceramic range patterns have been created to give a 3D effect to look like tiles but with all the advantages of a traditional reinforced liner.

- Guaranteed watertight
- Quick and easy installation compared to glass mosaic tiling
- No fallen tiles or crumbling grout
- Minimum maintenance
- 2mm thick
- Ideal for new pools and for renovations!
- Looks like traditional tiles
- Guaranteed for 10 years
- Slip Resistance Class C

**EXTREME®** is a registered trademark of Plastica Limited

\* Special Order



Ceramic Light Grey \*



Ceramic Black \*



Ceramic Blue \*

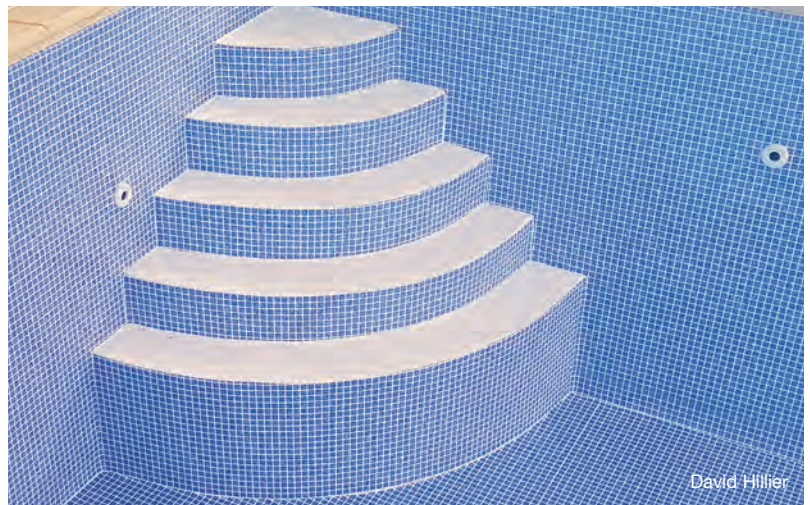

Top: Ceramic Blue  
Bottom: Ceramic Light Grey

David Hillier



**EXTREME®**  
POOL LINING SYSTEM

Martin Clark

**Note** colours may vary between material batches and look slightly different in our price list. For an accurate guide, contact Pat Devaney for a sample swatch and more information about the Extreme® Pool Lining System on 01424 857741 or email: pat@plasticapools.net

LINERS

# Extreme® 3D Pool Lining

SPECIAL ORDER

LINERS

An addition to the Extreme® range of lining is the 3D range of patterns. Manufactured in 2mm thick reinforced material incorporating a natural looking textured surface that makes it feel totally unique.

The 3D patterns are designed to give you a completely different swimming experience and give the effect of swimming in a natural environment. As you would expect from an Extreme lining, the material has multiple layers of protective lacquer to keep the liner looking as good as new from day one, whilst resisting the ageing and challenging conditions of a swimming pool.

The Extreme 3D range is available in five distinctive patterns, 3D White Marble, 3D Slate, 3D Sandstone, 3D Rustic and 3D Granite and are all manufactured and designed to make swimming in your pool a pleasure for years to come.

**EXTREME®** is a registered trademark of Plastica Limited



3D White Marble \*

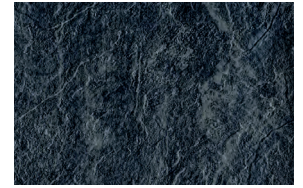

3D Slate \*



3D Sandstone \*

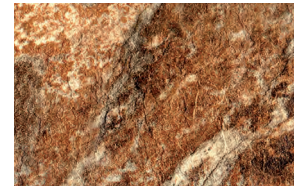

3D Rustic \*

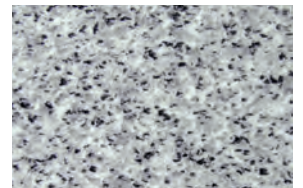

3D Granite \*

**Please note:**  
All are certified to Class C slip resistance.

\* Special Order



Panache Pools

Left: 3D Slate  
Bottom: 3D Rustic



**3D EXTREME® POOL LINING SYSTEM**

ABS Pools

**Note:** colours may vary between material batches and look slightly different in our price list. For an accurate guide, contact Pat Devaney for a sample swatch and more information about the Extreme® Pool Lining System on 01424 857741 or email: pat@plasticapools.net

# Extreme® Elite Pool Lining

SPECIAL ORDER

The first Chlorine resistant reinforced lining material for swimming pools. Thanks to a powerful protective shield both on its upper and lower surface, this coating is ideal for pools with aggressive water treatments or with a large influx of bathers.

- 5 year Guarantee on Colour
- 5 year Guarantee against staining
- **Non toxic material** – compatible with plants & fish
- Ideal for Public pools with heavy bathing loads
- Non slip available for steps and shallow areas
- High resistance to UV light so ideal for outdoor pools
- Protective lacquer prevents attack from chemicals and bacteria

**EXTREME®** is a registered trademark of Plastica Limited

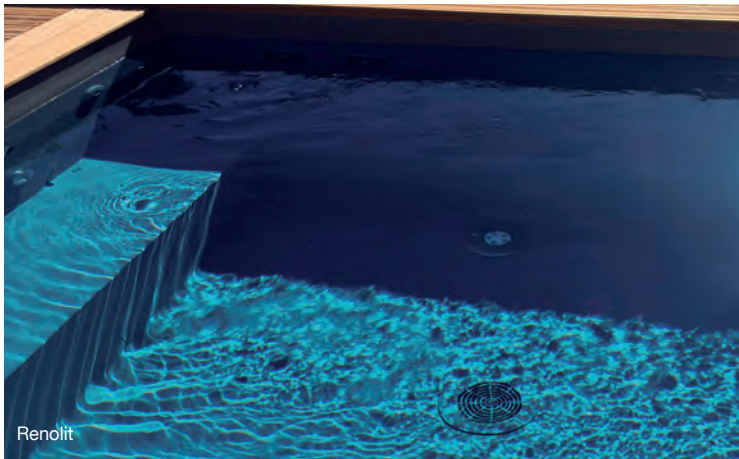

ELITE Ice \*



ELITE Sahara \*



ELITE Blue Fresh \*



ELITE Azur \*



ELITE Silver \*



ELITE Volcano \*

\* Special Order



ELITE Onyx \*

Left: ELITE Volcano  
Bottom: ELITE Ice

LINERS



**Note:** colours may vary between material batches and look slightly different in our price list. For an accurate guide, contact Pat Devaney for a sample swatch and more information about the Extreme® Pool Lining System on 01424 857741 or email: pat@plasticapools.net

# Extreme® Fixings and Accessories

SPECIAL ORDER

LINERS

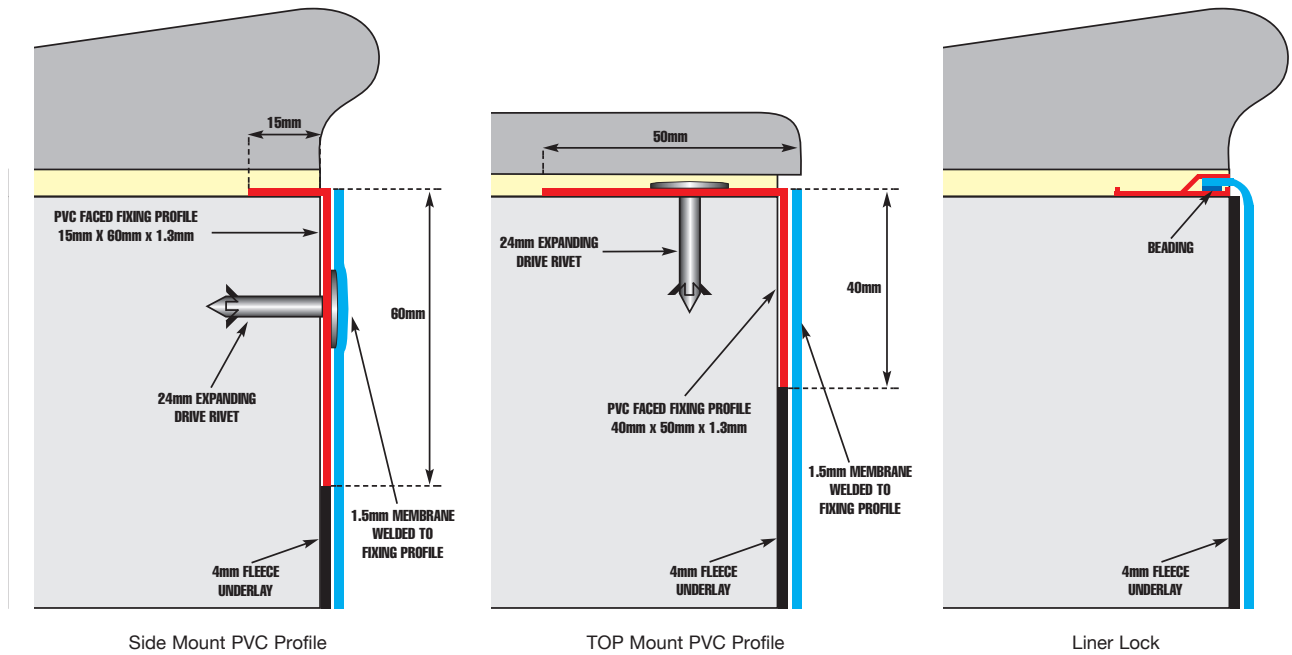

Side Mount PVC Profile

TOP Mount PVC Profile

Liner Lock

## Accessories available

- ⊗ Seam sealant for standard 1.5mm Reinforced material – 1Kg tin
- ⊗ Seam sealant for 2mm Extreme material – 1Kg tin
- ⊗ Seam sealant for 2mm Elite material – 950gm tin
- ⊗ Sealant application bottle with cap and nozzle
- ⊗ Beading – 9mm x 25m lg roll
- ⊗ Contact adhesive – Bostick 1782 – 5L tin
- ⊗ Side mount profile 65mm x 15mm x 2m Lg
- ⊗ Top mount profile 50mm x 40mm x 2m Lg
- ⊗ Flat profile 55m wide x 2m Lg

For prices of linerlock, fixing rivets and linerlock wedge see Page 54 & 56

**EXTREME®** is a registered trademark of Plastica Limited

Contact Plastica for details and prices

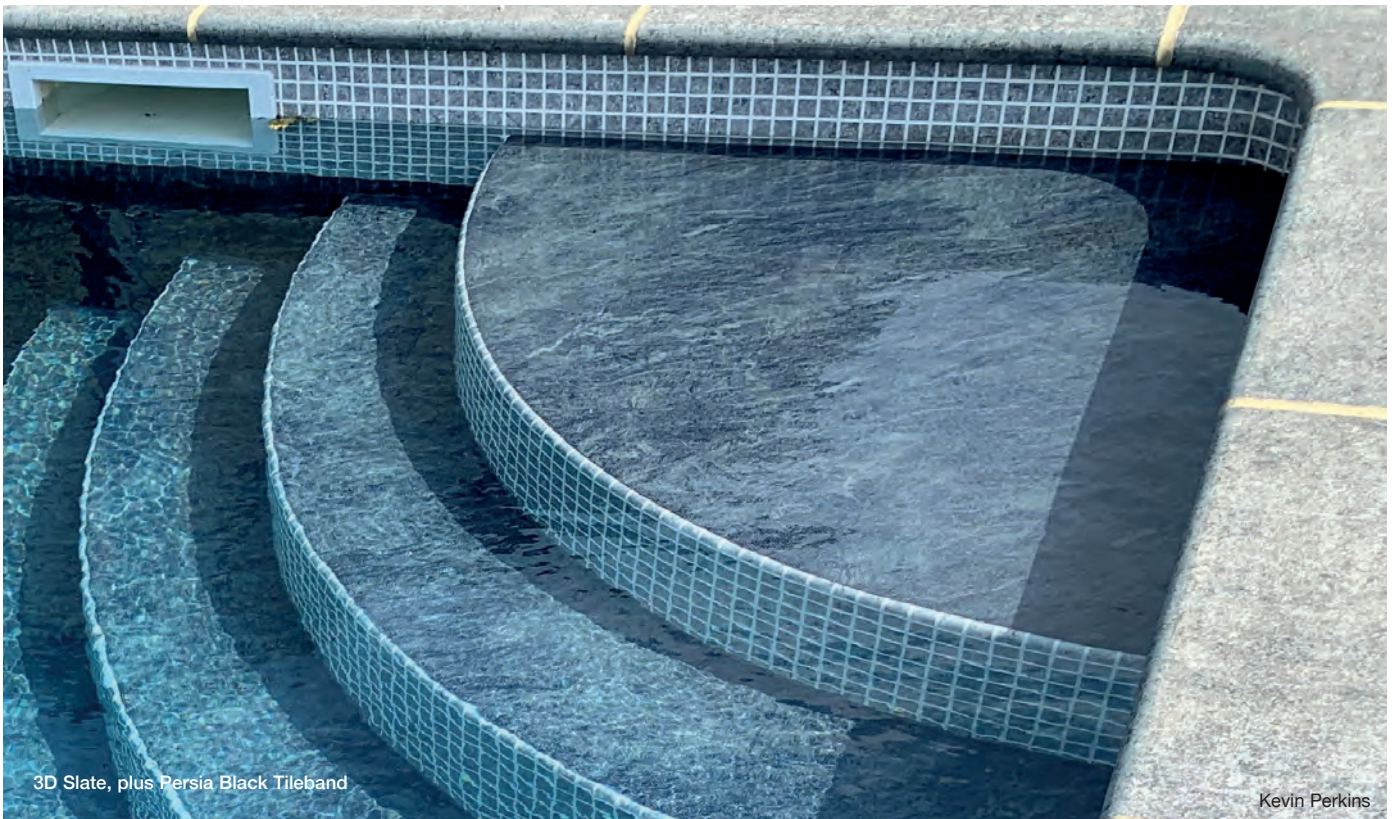

**Please note:** colours may vary between material batches and look slightly different in our price list. For an accurate guide, contact Pat Devaney for a sample swatch and more information about the Extreme® Pool Lining System on 01424 857741 or email: pat@plasticapools.net

# Pumps, Filters & Heating

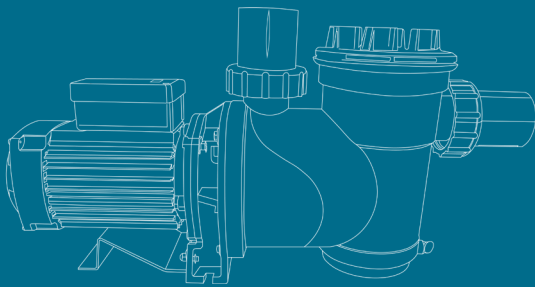

## Clever-Pool Pump Inverter

- Four default settings:  
Low RPM (1200)  
Medium RPM (1800)  
High RPM (2100)  
Backwash (2800)
- Manual mode allows finer adjustment of pump speed
- Four timing periods allow different pump speeds to be automatically used at different times of day
- LCD screen showing motor speed and timings
- 2.5m cable to pump / 90cm cable to plug
- Suitable for single phase pumps
- 2 year warranty
- 13amp plug fitted



### Clever-Pool Pump Inverter

DISCOUNT CODE/ PRODUCT CODE	DESCRIPTION	PRICE EACH
K CPI001	Clever-Pool Inverter	£405.00

- Up to 80% savings on pool pump energy consumption
- Simple installation
- Manual and Auto Mode
- Compatible with 95% of single speed pumps up to 2.0hp
- User friendly Control Panel

- Compatible with Argonaut Pumps
- Reduced wear and tear on your pool pump
- Reduced noise levels
- Improved filtration
- Set reduced speeds on your pump

## Capital outlay payback in just over 6 months

### Typical cost of running a 1hp pool pump continually for 1 month (30 days)

Energy consumption per month.....732kWh  
Price per kWh of electricity..... 25p per kWh  
**Monthly expenditure ..... £183.00**

### Typical monthly running cost for the same pool with same pump linked to a Clever-Pool

Energy consumption per month.....281.03kWh  
Price per kWh of electricity..... 25p per kWh  
**Monthly expenditure ..... £70.25**

## Savings per month = £112.75

Approximate capital outlay for Clever-Pool supplied and installed by a professional pool company ..... £600.00

The calculations shown are based on the following assumptions:  
Pool Pump is 1.0hp (0.75kW) Output  
1.02kW Input at 73% efficiency.

Illustrated calculation is based on Clever-Pool operating at the following parameters:

19 hours per day at  
1,200rpm pump speed .....173.91kWh per month  
1 hour per day at  
1,700rpm pool pump speed ..... 17.63kWh per month  
4 hours per day at  
2,100rpm pool pump speed ..... 89.50kWh per month

Figures may differ due to variable parameters, e.g. cost of kWh of energy, efficiency of pool circulation pump etc.  
Above figures based on a 30 day month.

All costs quoted include VAT

## Frost Protection

- Switches pump on when the water falls below set temperature
- Supplied complete with temperature probe
- Digital display of temperature
- Low and high set point are adjustable (on/off)
- Can be used with Clever-Pool Pump Inverter

### Frost Stat

DISCOUNT CODE/ PRODUCT CODE	DESCRIPTION	PRICE EACH
K DHG-2	Frost Protection Thermostat Controller	£124.00



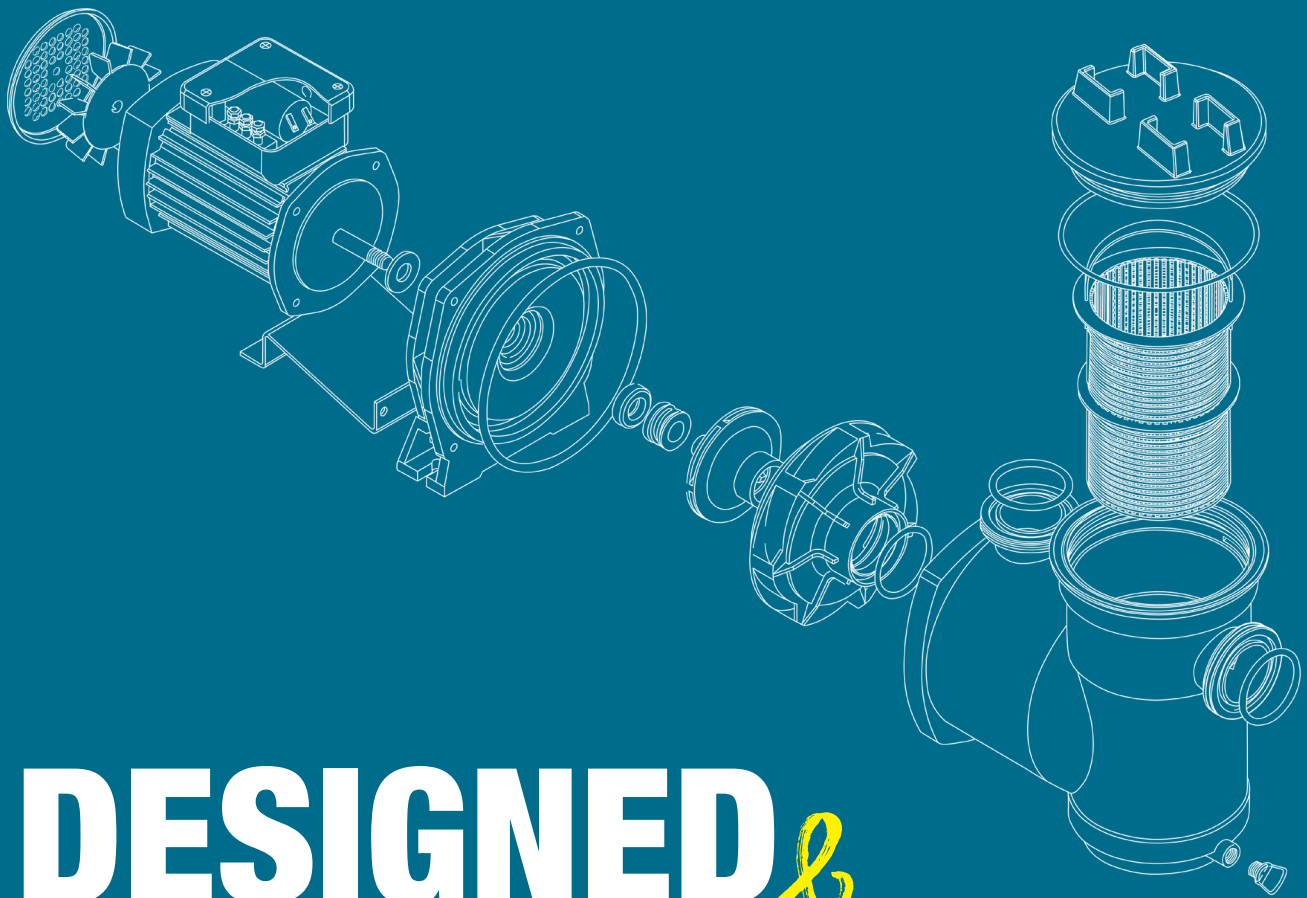

**DESIGNED &  
ENGINEERED**

*To outperform the rest*

**ARGONAUT<sup>®</sup>  
PUMP** 

**AG<sup>®</sup>  
PUMP** 



# Plastica Argonaut®

- Self priming to 3 metres
- Heavy duty long life IP55 rated motor
- Quiet running 60dB rating
- Glass filled polypropylene tank has a high chemical resistance
- High-grade stainless steel motor shaft
- AISI 316 carbon/ceramic mechanical seal
- Large 1.75 litre strainer basket and clear body lid or easy inspection
- Can be used with high salt water concentration
- ABS solvent weld unions 63mm/2" supplied with reducers for 50mm/1.5"

Performance Curve

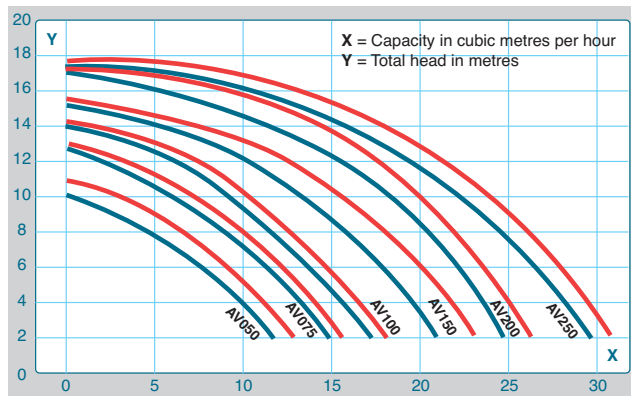

0.33HP = 0.24KW      0.75hp = 0.56kW      1.5hp = 1.12kW  
 0.5hp = 0.375kW      1hp = 0.75kW      2hp = 1.5kW

— Single phase  
 — Three phase

Three phase 1 H.P | 1.5 H.P |  
 2 H.P supplied with 1E3 motors.

3 years warranty on pump body, 2 years on motor,  
 1 year on pump seal.

**Note:** A non-return valve should be fitted after the pump to prevent the impeller from unwinding if strong backflow occurs.

## Plastica Argonaut® Single Phase

DISCOUNT CODE/ PRODUCT CODE	DESCRIPTION	PRICE EACH
O3 AV50-2DN-S	0.33hp 5.8m³/h at 9m head. 10m head max	£563.00
O3 AV75-2DN-S	0.5hp 8.2m³/h at 9m head. 13m head max	£577.00
O3 AV100-2DN-S	0.75hp 11m³/h at 9m head. 14m head max	£590.00
O3 AV150-2DN-S	1.0hp 14m³/h at 9m head. 15m head max	£656.00
O3 AV200-2DN-S	1.5hp 17m³/h at 9m head. 16m head max	£744.00
O3 AV250-2DN-S	2.0hp 22m³/h at 9m head. 17m head max	£896.00

## Plastica Argonaut® Three Phase

DISCOUNT CODE/ PRODUCT CODE	DESCRIPTION	PRICE EACH
O3 AV50-3DN-S	0.33hp 4.6m³/h at 9m head. 10m head max	£569.00
O3 AV75-3DN-S	0.5hp 7.8m³/h at 9m head. 13m head max	£590.00
O3 AV100-3DN-S	0.75hp 10m³/h at 9m head. 14m head max	£608.00
O3 AV150-3DN-2	1.0hp 15m³/h at 9m head. 15m head max	£878.00
O3 AV200-3DN-2	1.5hp 18m³/h at 9m head. 16m head max	£961.00
O3 AV250-3DN-2	2.0hp 24m³/h at 9m head. 17m head max	£1,129.00

Argonaut is a registered trademark of Plastica Limited



1-Phase	A	B	INPUT kW
AV50-2DN-S	144	533	0.45
AV75-2DN-S	145-180	533	0.60
AV100-2DNS-S	145-180	533	0.70
AV150-2DNS-S	145-180	561	1.00
AV200-2DNS-S	145-180	561	1.30
AV250-2DNS-S	145-180	564	1.80

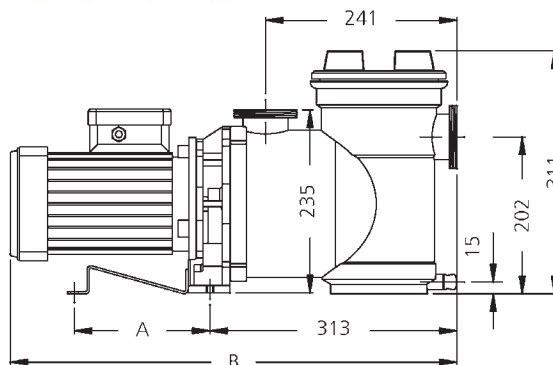
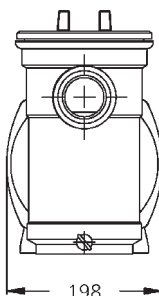



# Plastica AG Pump Series

- Self priming to 1.8 metres
- Heavy duty long life IP55 rated motor
- Quiet running 55dB rating
- Glass filled polypropylene tank has a high chemical resistance
- High-grade stainless steel motor shaft
- AISI 316 carbon/ceramic mechanical seal
- 1.65 Litre strainer basket and clear body lid for easy inspection
- Can be used with high salt water concentration
- ABS solvent weld unions 50mm/1.5"

Performance Curve

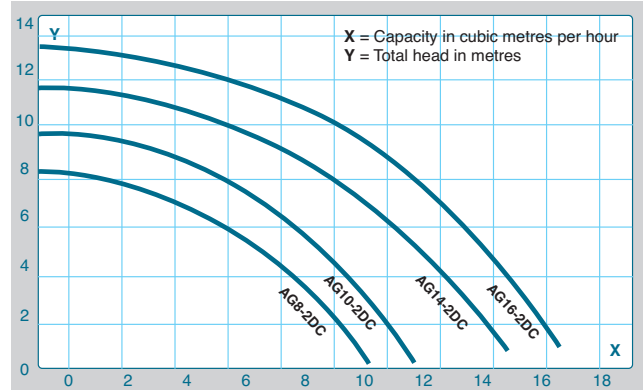

0.25hp = 0.19kW      0.33hp = 0.25kW  
 0.50hp = 0.37kW      0.66hp = 0.49kW

## Plastica AG Pumps

DISCOUNT CODE/ PRODUCT CODE	DESCRIPTION	PRICE EACH
O4 AG8-2DC	0.25hp - 5.8m³/h at 6m head. 8m head max	£354.00
O4 AG10-2DC	0.33hp - 6.3m³/h at 6m head. 10m head max	£356.00
O4 AG14-2DC	0.50hp - 10m³/h at 6m head. 12m head max	£358.00
O4 AG16-2DC	0.66hp - 11m³/h at 6m head. 13m head max	£360.00



3 years warranty on pump body, 2 years on motor,  
 1 year on pump seal.

**Note:** A non-return valve should be fitted after the pump to prevent the impeller from unwinding if strong backflow occurs.

1-Phase	INPUT kW
AG8-2DC	0.29
AG10-2DC	0.36
AG14-2DC	0.49
AG16-2DC	0.67

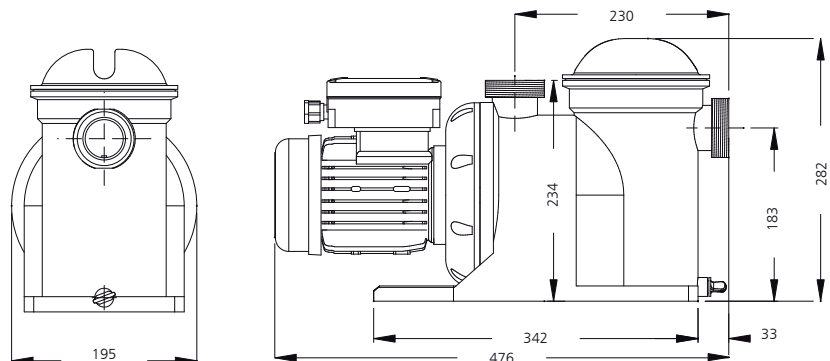

PUMPS, FILTERS & HEATING

- Proven reliability
- Outstanding value
- Simple to install
- Ultra quiet
- 1.5" suction, 1.5" delivery

iFlo®

DISCOUNT CODE/ PRODUCT CODE	DESCRIPTION	PRICE EACH
O2 SFP030	0.75hp 8.5m³/h at 8m head. 10m head max.	£339.00
O2 SFP100	1hp 12.5m³/h at 8m head. 15m head max.	£360.00
O2 SFP150	1.5hp 18.5m³/h at 8m head. 17m head max.	£376.00

**Note:** A non-return valve should be fitted after the pump to prevent the impeller from unwinding if strong backflow occurs.

Performance Curve

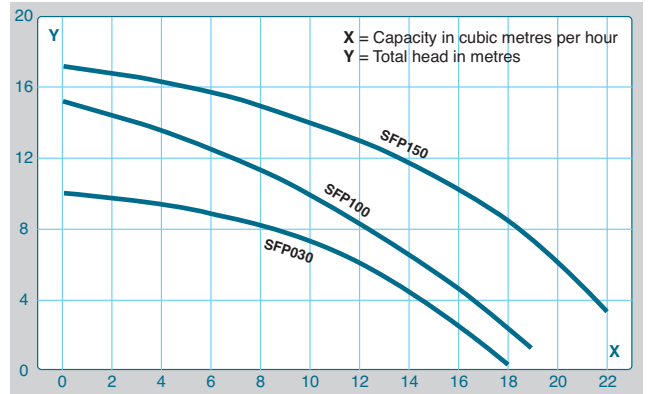

0.75hp = 0.56kW

1.0hp = 0.75kW

1.5hp = 1.12kW



iFlo® is a registered trademark of Plastica Ltd.

# Pentair Freeflo

- Drop-in replacement for Swimmey Pump
- Transparent lid for easy inspection of strainer basket
- Large self-aligning basket
- 50mm swivel union fittings for better sealing
- Discharge is 90° rotatable
- Additional drain plug for servicing pump housing
- Heavy duty long life IP55 rated motor
- Warranty: 2 years motor and motor components
- 1 year mechanical seal and related damages

Performance Curve

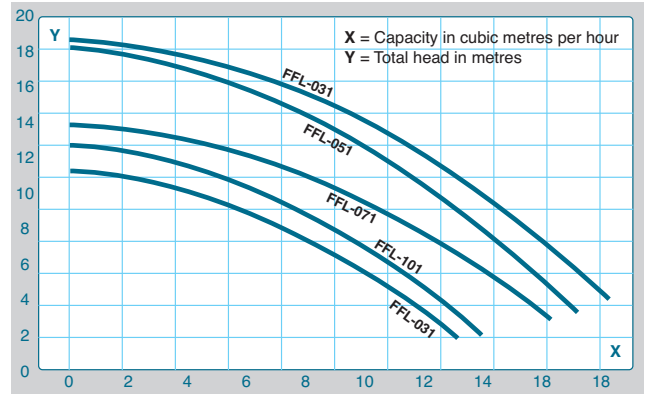

0.33hp = 0.25kW      0.75hp = 0.55kW      1.5hp = 1.1kW  
0.50hp = 0.375kW      1.0hp = 0.75kW

## Pentair Freeflo

DISCOUNT CODE/ PRODUCT CODE	DESCRIPTION	PRICE EACH
O FFL-031	0.33hp	£401.10
O FFL-051	0.50hp	£413.70
O FFL-071	0.75hp	£446.25
O FFL-101	1.0hp	£460.95
O FFL-151	1.5hp	£513.45

**Note:** A non-return valve should be fitted after the pump to prevent the impeller from unwinding if strong backflow occurs.

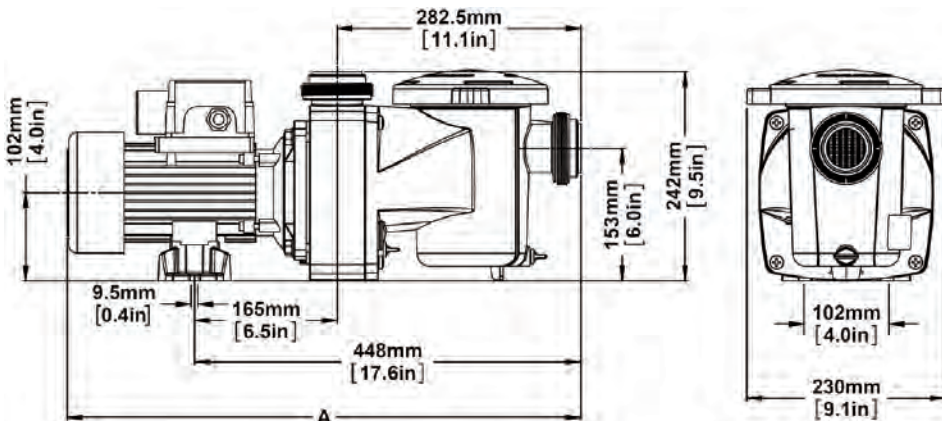

OUTPUT POWER		DIMENSION "A"
WATTS	HP	
250W	1/3	540 mm (21.3 in)
370W	1/2	540 mm (21.3 in)
550W	3/4	562 mm (22.2 in)
750W	1	562 mm (22.2 in)
1100W	1.5	600 mm (23.6 in)

# ESPA Multipool N

## Materials

Pump body, base and diffusers in polymeric materials.  
 Shaft in stainless steel AISI 431. Wet end with AISI 431 metallic components. Mechanical seal in graphite and alumine. Motor housing in aluminium L-2521. Windings impregnated with polyester resin.

## Motor

Asynchronous, two poles.  
 IP 55 protection.  
 Class F insulation.  
 Continuous operation.  
 Single-phase with built-in thermal protection.

- Multi-stage booster pumps for pool cleaners.
- Designed for operation with chlorinated and, salt water

Warranty: 2 years motor and motor components. 1 year mechanical seal and related damages.

Performance Curve

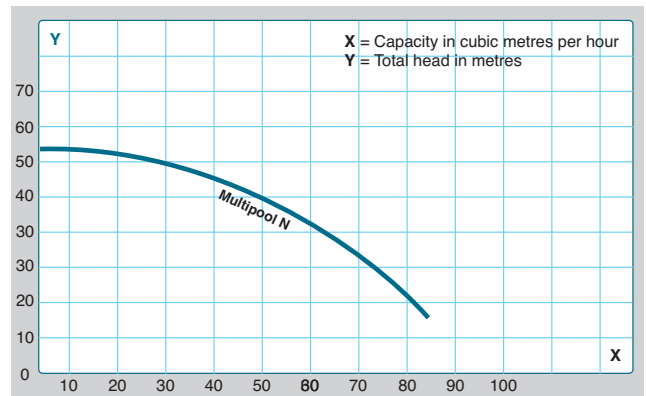

1hp = 0.75kW



**Note:** A non-return valve should be fitted after the pump to prevent the impeller from unwinding if strong backflow occurs.

## ESPA Multipool N

DISCOUNT CODE/ PRODUCT CODE	DESCRIPTION	PRICE EACH
O MPN100	Multipool N 1.00hp	£464.00

To connect to 1.5" pipework please use two of each of the below fittings:

## Installation Accessories

DISCOUNT CODE/ PRODUCT CODE	DESCRIPTION	PRICE EACH
H PVC335	1" Barrel Nipple P/T	£2.77
H PVC925	1.5" - 1" P/P Bush	£1.42

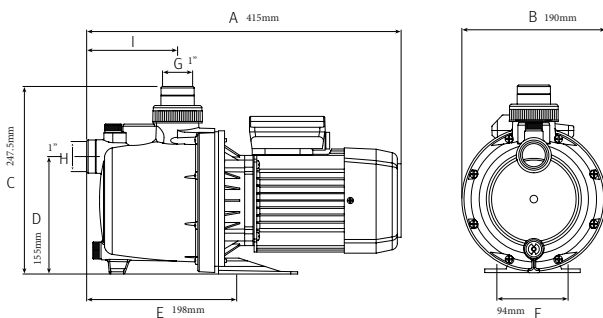

Model	A	B	C	D	E	F	G	H	I
Multipool N	415	190	247.5	155	198	94	1"	1"	120
Weight	10.5kg								

# Side Mount Endurance® Filters

PALLET

Gelcoat filter tank has been well-received by the industry due to the durability, trustworthy performance and smooth gelcoat fiberglass finish. With prolonged UV-resistant material used, it is able to operate under sunlight for years of reliability. "SMG" Series side mount filters are equipped with a six-position, side mount multiport valve and ABS laterals.

- Non corrosive gel coat fiberglass tank
- Smooth finishing
- Curved valve connecting elbow to reduce heat loss
- Transparent lid provides clear view of filter media
- Air release valve
- 6 way multiport side mount valve included



## Side Mount Endurance Filters

DISCOUNT CODE/ PRODUCT CODE	DESCRIPTION	PRICE EACH
O2 ENDG500	Gelcoat Filter 20" c/w 1.5" multiport valve	£505.00
O2 ENDG650	Gelcoat Filter 25" c/w 1.5" multiport valve	£682.00
O2 ENDG750	Gelcoat Filter 30" c/w 2" multiport valve	£780.00
O2 ENDG900	Gelcoat Filter 36" c/w 2" multiport valve	£1,030.00

### Features

- Suggested installations: Domestic pools, Commercial pools, Above-ground pools and Spa pools
- Max operating pressure 36 psi / 2.5bar
- Max temperature of 43°C (109°F)
- Universal standard of union connection provided
- Suggested size of media: 0.5mm-0.8mm

Side Mount filter is equipped with:

- 6-way multiport valve
- Universal standard of union connection
- Pressure gauge
- ABS lateral system
- Piping kit

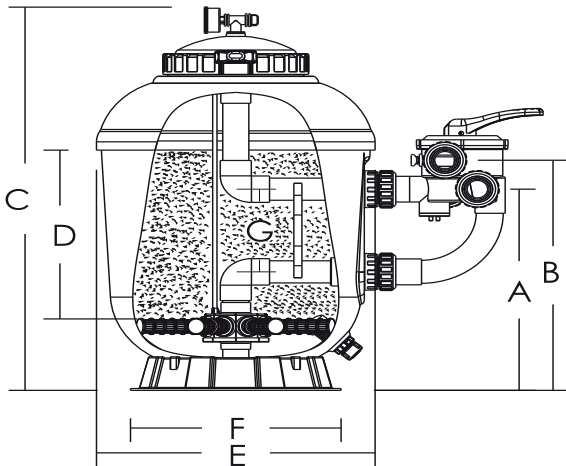

### Product Dimensions

Model No.	A mm	B mm	C mm	D mm	E mm	F mm	G mm
ENDG500	438	501	835	360	516	390	180
ENDG650	453	516	926	380	666	390	180
ENDG750	517	603	1023	440	770	500	220
ENDG900	570	656	1163	480	920	780	220

### Technical Information

Model No.	Filter Area	Value Connections	Max Flow Rate	Sand (kg)
ENDG500	0.20	1.5inch 50mm	167lpm 10.00m³/h	100
ENDG650	0.33	1.5inch 50mm	275lpm 16.050m³/h	150
ENDG750	0.44	2.0inch 63mm	369lpm 22.10m³/h	250
ENDG900	0.64	2.0inch 63mm	531lpm 31.80m³/h	375

**Note:** Suggested weight varies with differences in filter media size, for reference only.

**Warranty:** Tank 5 years, Service parts 90 days.

PUMPS, FILTERS  
& HEATING

# Lacron SureFlow LSR Sand Filter

PALLET

- 18" to 30" models held in stock
- High quality construction
- Complete with valve and pressure gauge
- Warranty: 10 years (5 years full + 5 years pro rata warranty) tank warranty. Other components, 1 year.



## Lacron SureFlow LSR

DISCOUNT CODE/ PRODUCT CODE	DESCRIPTION	PRICE EACH
O LDF018	18" with 1.5" MPV	£803.25
O LDF024	24" with 1.5" MPV	£1,004.85
O LDF030	30" with 2" MPV	£1,684.20

Model	Tank Diameter (mm)	Bed Depth (mm)	Filter Area (m <sup>3</sup> )	Valve Size (mm/inch)	Pea Gravel (kg)	Sand (kg)	EcoPure (kg)	Glass Pearl (kg)	Max. Flow (m <sup>3</sup> /h)	Max. Pool Size (m <sup>3</sup> /h)
LDF-018	460	350	0.160	50/1.5"	NR	75	60	82	8.5	50
LDF-024	610	380	0.300	50/1.5"	NR	125	100	138	14.5	85
LDF-030	760	400	0.460	63/2"	50	150	125	165	22.5	130

### Measurements

Model	A	B	C	D	E	F	G	H	I	J	K	J	J
LDF-018	78	457	475	230	54	204	240	630	65	70	372	790	350
LDF-024	78	610	620	230	54	204	291	733	65	88	485	945	380
LDF-030	70	762	784	230	81	214	290	767	85	90	620	1100	400

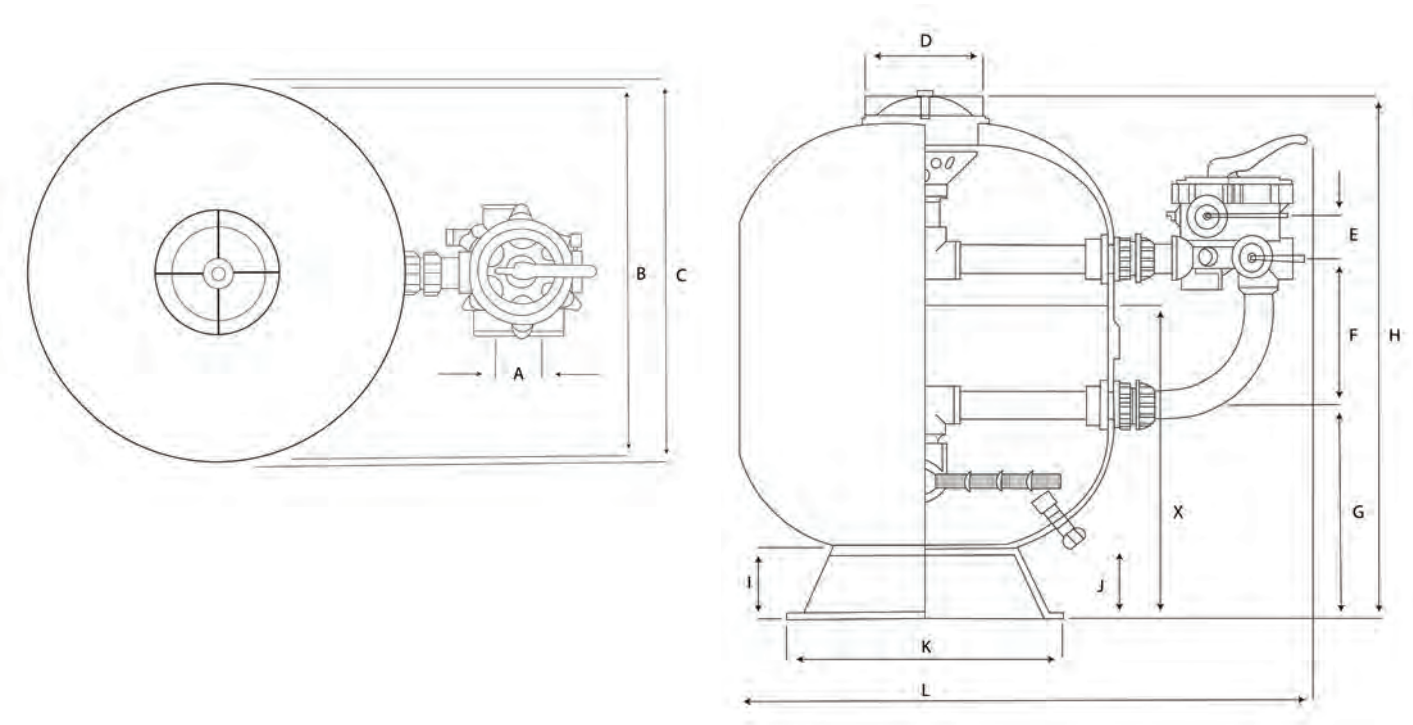

PUMPS, FILTERS & HEATING

# Tagelus®

PALLET

- One piece reinforced fibreglass tank
- Valve can be fitted in any position
- Easy drainage
- Complete with valve and gauge
- One piece reinforced tank
- 6-Way multiport valve
- 3.5 bar maximum operating pressure
- 50°C maximum operating temperature
- Warranty: 10 years shell only. 90 days for service parts.

## Tagelus®

DISCOUNT CODE/ PRODUCT CODE	DESCRIPTION	PRICE EACH
O F-19T6-TAG	19" TA40	£554.40
O F-24T6-TAG	24" TA60	£646.80
O F-30T8-TAG	30" TA100	£854.70



PUMPS, FILTERS  
& HEATING

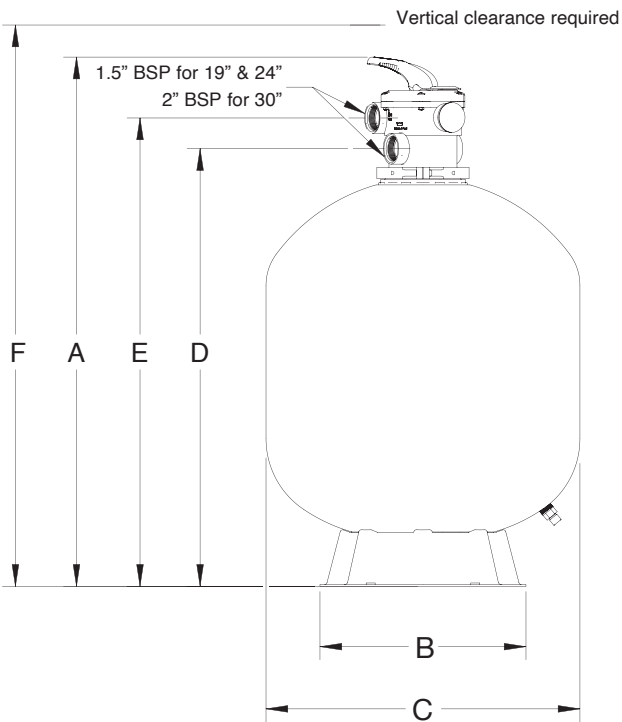

	F-19T6-TAG	F-24T6-TAG	F-30T6-TAG
A	878	1009	1170
B	400	400	610
C	480	610	762
D	715	847	1026
E	774	904	1108
F	1194	1448	1664

MODEL	Filter (mm)	Recommended flow rate (m <sup>3</sup> /h)	Filter Area (m <sup>2</sup> )	Flange Connection	Sand 0.4 - 0.8 mm (kg)	Gravel 3-5mm (kg)	Clearance distance (mm)	Maximum working pressure (bar)	Valve
F-19T6-TAG	480	8,5	0,17	1.5"	70	15	985	3,5	6-way
F-24T6-TAG	610	14	0,29	1.5"	150	17	1115	3,5	6-way
F-30T8-TAG	762	22	0,45	2"	235	50	1286	3,5	6-way

- 360° diffuser
- Clear lid for observation
- Easy to use water drain
- Complete with valve and gauge
- One piece reinforced tank
- UV resistant
- 8.5" closure
- 3.5 bar maximum operating pressure
- 50°C maximum operating temperature
- Manufactured in Europe
- Warranty: 10 years shell only. 90 days for service parts.

Triton®

DISCOUNT CODE/ PRODUCT CODE	DESCRIPTION	PRICE EACH
O F-19S8-TRV	19" TR40 c/w 1.5" multiport valve e gauge	£678.30
O F-24S8-TRV	24" TR60 c/w 1.5" multiport valve e gauge	£774.90
O F-30S8-TRV	30" TR100 c/w 2" multiport valve e gauge	£1,034.25
O F-36S8-TRV	36" TR140 c/w 2" multiport valve e gauge	£1,478.40



PUMPS, FILTERS  
& HEATING

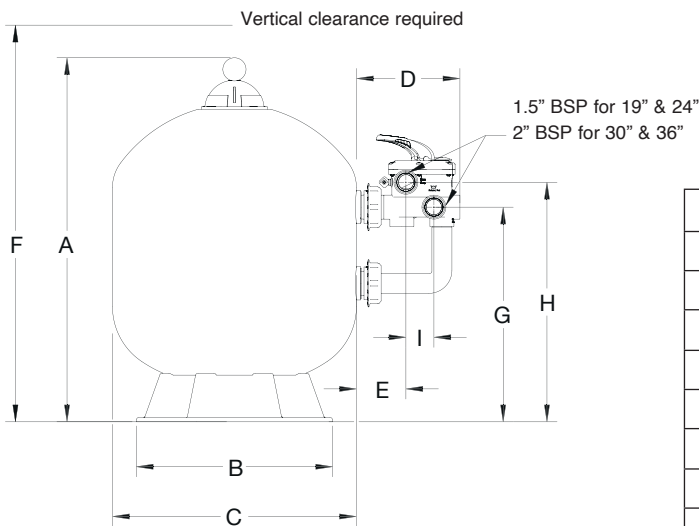

	F-19S8-TRV	F-24S8-TRV	F-30S8-TRV	F-36S8-TRV
A	825	955	1095	1200
B	400	400	610	610
C	480	610	762	914
D	252	252	302	302
E	120	120	160	160
F	876	1006	1146	1251
G	463	530	590	657
H	524	592	671	738
I	70	70	70	70

MODEL	Filter (mm)	Recommended flow rate (m³/h)	Filter Area (m²)	Flange Connection	Sand 0.4 - 0.8mm (kg)	Gravel 3-5mm (kg)	Clearance Distance (mm)	Maximum Working Pressure (bar)	Valve
F-19S8-TRV	480	8.5	0.17	1.5"	52	20	825	3.5	6-way
F-23S8-TRV	610	14	0.29	1.5"	108	40	955	3.5	6-way
F-30S8-TRV	762	22	0.45	2"	200	80	1005	3.5	6-way
F-36S8-TRV	914	32	0.64	2"	310	120	1200	3.5	6-way

## iFlo® 500 Filter Pump Pack

- Outstanding value 550kW 0.75hp pump
- Quality 6-way multi-port valve, connecting hose, pressure gauge and base plate
- 500mm filter tank
- Simple to install
- Ultra quiet self priming pump with pre-filter

### iFlo 500

DISCOUNT CODE/ PRODUCT CODE	DESCRIPTION	PRICE EACH
O2 SFP500	Filter Pump Pack	£408.50

The max flow rate of the filter is 17m<sup>3</sup> per hour.  
(This is limited by site specific factors including size of pipe work, bends, other items installed that the water is passed through.)



PUMPS, FILTERS  
& HEATING

MODEL	TANK VOLUME	TANK DIAMETER	PRODUCT HEIGHT	BUILT-IN	INLETS & OUTLETS	MAX. WORKING PRESSURE	GROSS WEIGHT	MEDIA REQUIRED
iFlo 500	75L	500mm	840mm	7-way valves	50mm	1.5bar	19kg	75kg (3 bags)

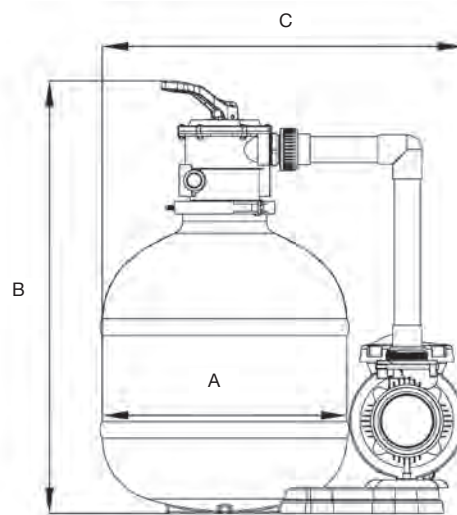

MODEL	A	B	C
iFlo 500	485mm	840mm	720mm

## iFlo Junior 310 Filter Pump Pack

- An excellent value 250kW 0.33hp pump
- Quality 7-way multi-port valve, connecting hose, pressure gauge and base plate
- 310mm filter tank
- Adaptors for pool hoses 32-38mm connection
- Simple to install
- Ultra quiet self priming pump with pre-filter



### iFlo Junior 310 Filter Pump Pack

DISCOUNT CODE/ PRODUCT CODE	DESCRIPTION	PRICE EACH
O2 SFP310	iFlo Junior 310 Filter Pump Pack	£277.00

**Note:** The max flow rate of the filter is 5.2m<sup>3</sup> per hour.  
(This is limited by site specific factors including size of pipe work, bends, other items installed that the water is passed through).

PUMPS, FILTERS  
& HEATING

MODEL	TANK VOLUME	TANK DIAMETER	PRODUCT HEIGHT	BUILT-IN	INLETS & OUTLETS	MAX. WORKING PRESSURE	GROSS WEIGHT	MEDIA REQUIRED
JUNIOR 310	20L	310mm	605mm	7-way valves	32-38mm	1.5bar	11.7kg	20kg (1 bag)

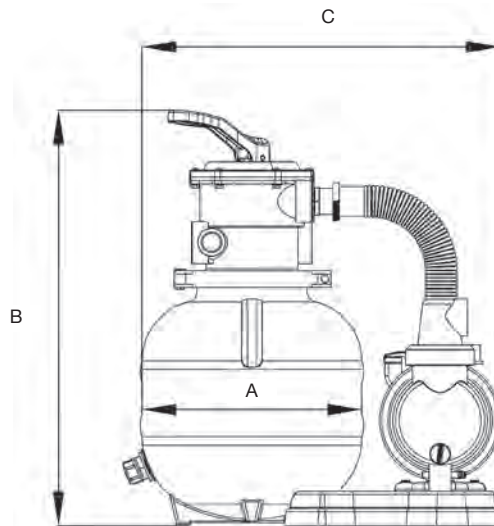

MODEL	A	B	C
310	485mm	605mm	525mm

# Sta-Rite Azur/FreeFlo™ Filter Pump Pack

- Fast and easy set up
- Single piece thermoplastic moulded tank
- Large strainer basket reduces emptying frequency
- Union connections for quick installation and servicing
- Unified pump/filter base for secure system installation

## Azur/FreeFlo™ Filter Pump Pack

DISCOUNT CODE/ PRODUCT CODE	DESCRIPTION	PRICE EACH
O FS-15A6-FF10	0.33hp Pump, 375mm Filter, 6-way Valve	£787.50
O FS-19A6-FF12	0.50hp Pump, 475mm Filter, 6-way Valve	£813.75
O FS-22A6-FF15	0.75hp Pump, 560mm Filter, 6-way Valve	£850.50

Model	Size	Media Required
FS-15A6-FF10	15"	2 bags
FS-15A6-FF12	19"	3 bags
FS-14A6-FF15	22"	4 bags

(for guidance only)



PUMPS, FILTERS  
& HEATING

**Warranty:** Filter 2 years, Service parts 90 days, Pump motor and main components 2 years, Mechanical seal & related damages 1 year.

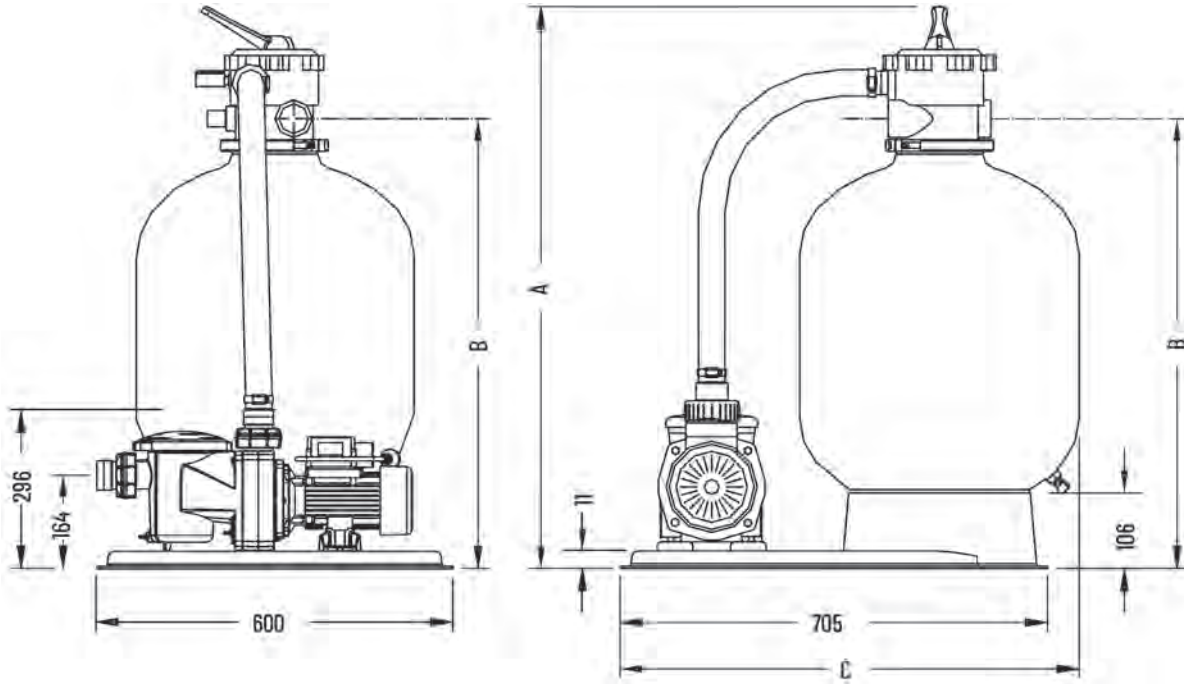

MODEL	A	B	C
FS-15A6-FF10	870mm	640mm	710mm
FS-15A6-FF12	870mm	640mm	710mm
FS-14A6-FF15	900mm	720mm	760mm

# Krystal Clear® Sand Filter Pump Packs

- Suitable for above ground pools
- 6-way multiport valve
- 24 hour automatic timer
- Pressure gauge
- Complete with connectors and flexible pipe for Intex pool

### 26644 Specification

- 4m³ per hour flow rate
- 10" (254mm) diameter tank
- 0.25hp pump
- 12kg sand capacity



Krystal Clear – 26644

## Krystal Clear

	DISCOUNT CODE/ PRODUCT CODE	DESCRIPTION	PRICE EACH
L	26644	0.25hp 4m³ per hour filter pump pack	£259.00

## Rigid Pipe Conversion Kit

	DISCOUNT CODE/ PRODUCT CODE	DESCRIPTION	PRICE EACH
L	AFP071	Rigid pipe conversion kit	£38.95

Converts to 1.5" rigid ABS pipe



Rigid Pipe Conversion Kit – AFP071



Connectors and flexible pipe included

PUMPS, FILTERS  
& HEATING

# Relax

## family of filters



WE'VE ADDED  
EVEN MORE TO  
OUR RANGE!

See full range  
on pages 211-212

Great Value! Great Performance! Order Yours Now!

# Krystal Clear® Sand Filter Pump Packs

- Suitable for above ground pools
- 6-way multiport valve
- 24 hour automatic timer
- Pressure gauge
- Complete with connectors and flexible pipe for Intex pool

### 26646 Specification

- 6m³ per hour flow rate
- 12" (305mm) diameter tank
- 0.30hp pump
- 23kg sand capacity
- Basket included on pump

### 26648 Specification

- 8m³ per hour flow rate
- 14" (360mm) diameter tank
- 0.60hp pump
- 35kg sand capacity
- Basket included on pump

### 26652 Specification

- 9.2m³ per hour flow rate
- 16" (410mm) diameter tank
- 0.75hp pump
- 55kg sand capacity
- Basket included on pump

## Krystal Clear

DISCOUNT CODE/ PRODUCT CODE	DESCRIPTION	PRICE EACH
L 26646	0.3hp 6m³ per hour filter pump pack	£309.00
L 26648	0.60hp 8m³ per hour filter pump pack	£377.00
L 26652	0.75hp Pump, 9.2m³ per hour filter pump pack	£399.00



6-way valve



Pressure Gauge



Krystal Clear – 26646 Filter pump pack



Heavy Duty Tank



Strainer Basket



Built-in Timer



Powerful Motor

## Cartridge Filter Pump Units

- Easy installation
- Double insulated with air release valve
- Automatic timer

28602BS suitable for 10' Metal Frame, 8' & 10' Easy Set Pool  
 28604BS suitable for 12' Metal Frame, 8' & 12' Easy Set Pool  
 28638BS suitable for 15' Metal Frame & 15' Easy Set Pool  
 28636BS suitable for 18' Metal Frame Pool

### Cartridge Filter Pump Units

DISCOUNT CODE/ PRODUCT CODE	DESCRIPTION	PRICE EACH
L 28602BS	1,136 litres per hour	£50.00
L 28604BS	1,798 litres per hour	£55.00
L 28638BS	2,839 litres per hour	£70.00
L 28636BS	4,466 litres per hour	£130.00
L 29059	Accessory Hose 1.5m x 32mm (1.25")	£15.00
L 29060	Accessory Hose 1.5m x 38mm (1.5")	£16.30



28604BS



28638BS

Type H filter cartridge fits filter model 28602

Plastica's Relax Pool filter cartridges are compatible with filter models 28604, 28638 and 28636

Type B filter cartridge fits filter model 28634

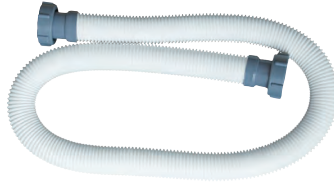

Accessory Hose – 29060

### Intex Cartridge for Above Ground Filter Pump Units

DISCOUNT CODE/ PRODUCT CODE	DESCRIPTION	PRICE EACH
S1 29007	Intex Type H Filter Cartridge	£4.95
S1 29005	Intex Type B Filter Cartridge	£11.40

### Relax Cartridge for Above Ground Filter Pump Units

DISCOUNT CODE/ PRODUCT CODE	DESCRIPTION	PRICE EACH
RFINTA	Relax Filter Cartridge	£2.90
RFINTAPK2	Relax Filter Cartridge Pack of 2	£5.70

### Pleatco Filter Wash

DISCOUNT CODE/ PRODUCT CODE	DESCRIPTION	PRICE EACH
NETT PWASH-POOL	Pleatco Pool Filterwash Tablet Single	£5.00
NETT PWASH-POOL-PAK	Pleatco Pool Filterwash Display Box of 30	£130.00

The above prices are nett



Pleatco Pool Filterwash Single Tablet  
PWASH-POOL



x30 Pleatco Pool Filterwash Display Box  
PWASH-POOL-PAK

## Waterco Cartridge Filters

- 1.5" connections
- 11.4m<sup>3</sup>/hour maximum flow
- 3.5 bar working pressure

### Waterco Cartridge Filters

DISCOUNT CODE/ PRODUCT CODE	DESCRIPTION	PRICE EACH
K WCF100	Top Load Filter (50 sq ft)	£168.00
KK AF1062	Base for above	£9.98

### Replacement Cartridge

DISCOUNT CODE/ PRODUCT CODE	DESCRIPTION	PRICE EACH
S3 62010	50sq ft Cartridge for WCF-100	£100.45



Plastica  
www.plasticapools.net



## Multiport Valves

### 1.5in Multiport Valve 6 Way Lacron Type

DISCOUNT CODE/ PRODUCT CODE	DESCRIPTION	PRICE EACH
K MVA024	6-Way Lacron - 1.5" (white pre 2004)	£97.34



### 1.5in Multiport Valve 6 Way 3D Max Type

DISCOUNT CODE/ PRODUCT CODE	DESCRIPTION	PRICE EACH
K MVA025	6-Way 3D / Max 1.5"	£93.00



### 2in Multiport Valve 6 Way Lacron Type

DISCOUNT CODE/ PRODUCT CODE	DESCRIPTION	PRICE EACH
K MVA027	6-Way Lacron - 2" (white pre 2004)	£154.35



### 1.5in Allport Open Multiport Valve

DISCOUNT CODE/ PRODUCT CODE	DESCRIPTION	PRICE EACH
K MVA150	Allport	£125.00



## Multiport Valves

### 1.5in Plastica Top Mount Multiport Valve

DISCOUNT CODE/ PRODUCT CODE	DESCRIPTION	PRICE EACH
K MVA250	Plastica Top Mount - 1.5"	£113.00



### 1.5in Onga MPV 6 Way

DISCOUNT CODE/ PRODUCT CODE	DESCRIPTION	PRICE EACH
K R14965TM10	6-Way Onga - 1.5"	£187.95



### 1.5in Triton Plumbed Multiport Valve

DISCOUNT CODE/ PRODUCT CODE	DESCRIPTION	PRICE EACH
K RE261070ND	Triton - 1.5" TRV40/TRV60	£202.65



### 2in Triton Plumbed Multiport Valve

DISCOUNT CODE/ PRODUCT CODE	DESCRIPTION	PRICE EACH
K RE261071ND	Triton - 2" TRV100/TRV140	£292.95



## Multiport Valves

### 1.5in Valve 6-way Top Mount BSP

DISCOUNT CODE/ PRODUCT CODE	DESCRIPTION	PRICE EACH
K RE272026ND	Azur / Tagelus - 1.5" TAG40/60	£171.68



### 2in Tagelus MPV

DISCOUNT CODE/ PRODUCT CODE	DESCRIPTION	PRICE EACH
K RE272029ND	Tagelus - 2" TAG100	£288.75



### 1.5in Hayward 710 Multiport Valve Sidemount

DISCOUNT CODE/ PRODUCT CODE	DESCRIPTION	PRICE EACH
K MVA710	Hayward 710 - 1.5"	£185.00



### 2in Hayward 715 Variflo Multiport Valve Sidemount

DISCOUNT CODE/ PRODUCT CODE	DESCRIPTION	PRICE EACH
K MVA715	Hayward 715 - 2"	£349.00



## Multiport Valves

### 1.5in IFlo MPV 6way

DISCOUNT CODE/ PRODUCT CODE	DESCRIPTION	PRICE EACH
K SFP010	iFlo 500	£84.00



### 2"/63mm Multiport Valve Post 2004 Lacron

DISCOUNT CODE/ PRODUCT CODE	DESCRIPTION	PRICE EACH
KK 2290512	6-Way Lacron/Waterco 2"/63mm (black post 2004)	£233.10



### 1.5" Lacron Multiport Valve

DISCOUNT CODE/ PRODUCT CODE	DESCRIPTION	PRICE EACH
K MVA034	6-Way Lacron - 1.5" (black post 2004)	£168.00



### 1.5" 6-Way Top Mount (for Waterco Filter Pump)

DISCOUNT CODE/ PRODUCT CODE	DESCRIPTION	PRICE EACH
K MVA228	6-Way Top Mount (for Waterco Filter Pump Pack) - 1.5"	£211.05



## Glass Filter Media

HEAVY ITEM PALLET

- Improves water clarity
- Removes particles as small as 5 microns
- Pay back period of less than 12 months
- Reduced chemical usage
- Less wastage of heated and treated water
- Resists bacterial contamination



- Longer lasting (no need to replace every 5 years)
- Chloramines greatly reduced
- 50% less water required to backwash
- 10% less media required than sand

### 25kg Bags

DISCOUNT CODE/ PRODUCT CODE	DESCRIPTION	PRICE EACH
K GFM001	Grade 1 filter media (0.5 - 1mm)	£15.60
K GFM003	Grade 3 filter media (3 - 6mm)	£15.60
K GFM001P	Grade 1 filter media (0.5 - 1mm) 40 bags *	£570.00

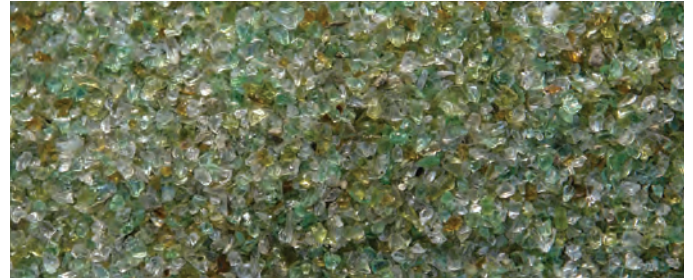

\*One pallet equals 40 bags of glass filter media.

## Silica Sand Filter Media

HEAVY ITEM PALLET

### Silica Sand - 25kg Bags

DISCOUNT CODE/ PRODUCT CODE	DESCRIPTION	PRICE EACH
K MVA750	16/30 grade filter media	£14.00
K MVA750P	16/30 grade filter media 40 bags *	£520.00



\*One pallet equals 40 bags of sand filter media.

## Glass Pearls Media

HEAVY ITEM PALLET

Manufactured from 100% virgin glass, Waterco glass pearls are a new generation of filter media, capable of providing water of superior clarity and requiring less water for backwashing.

- Advanced Filtration
- Superior Water Clarity
- Reduced Backwashing Times
- Energy and Water Saving
- Media Longevity
- 0.6mm to 0.8mm in size
- Chemically inert and free from contaminants

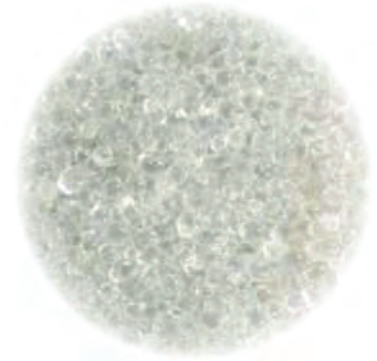

### Glass Pearls Media 20kg Bags

DISCOUNT CODE/ PRODUCT CODE	DESCRIPTION	PRICE EACH
K GPM001	Grade 1 Glass Pearls Media	£45.50
K GPM001P	Grade 1 Glass Pearls Media 50 bags	£2,160.00

**Note:** Filter media is excluded from free delivery.

## Multi Cyclone Cartridges

### Multi Cyclone Cartridges

DISCOUNT CODE/ PRODUCT CODE	DESCRIPTION	PRICE EACH
K 62451	40 Sq Ft Cartridge	£102.90
K 62453	75 Sq Ft Cartridge	£130.20



## Pressure Gauges

### Pressure Gauges

DISCOUNT CODE/ PRODUCT CODE	DESCRIPTION	PRICE EACH
K MVA402	50mm Side Mount 0-90psi - 0.25" BSPT	£13.00
K MVA404	50mm Side Mount 0-30psi - 0.125" BSPT	£13.00
K TFT10003	50mm Back Mount 0-60psi - 0.25" BSPT	£13.00
K EFI010	50mm Back Mount - 0.125" BSPT	£13.00
K GAU002	Deluxe Back Mount Glycerine Filled - 0.25" BSPT	£19.50



## Reinforced Backwash Hoses

### 1.5" Reinforced Backwash Hose

DISCOUNT CODE/ PRODUCT CODE	DESCRIPTION	PRICE EACH
H RBW015	15m Reel	£52.60
H RBW030	30m Reel	£105.00



PUMPS, FILTERS  
& HEATING

## Backwash Hose

### 1.5" Backwash Hose

DISCOUNT CODE/ PRODUCT CODE	DESCRIPTION	PRICE EACH
M PBW050	15m Reel	£19.50



## Hose Clips

### Hose Clip

DISCOUNT CODE/ PRODUCT CODE	DESCRIPTION	PRICE EACH
K JUB087	Small (13-20mm)	£4.00
K JUB162	Medium (30-40mm)	£4.00
K JUB212	Large (45-60mm)	£5.90





# Heat Exchangers

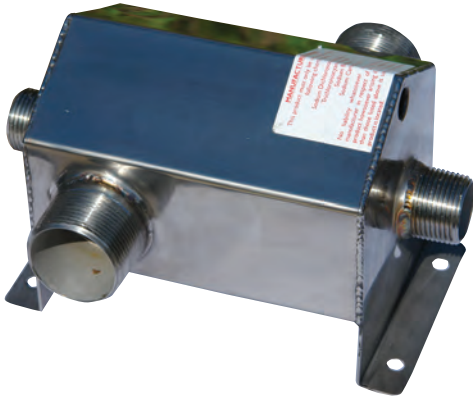

Heat Exchanger 17.5kW – WHE060

- Ideal for installation on a household heating system
- Stainless steel
- Built in 0.5" Probe Pocket
- One year warranty

**Note:** The value of the unit should be matched to or below the heat value of the household heater. Not suitable for use with salt water.



Heat Exchanger 50kW – WHE170

## Stainless Steel Heat Exchangers

DISCOUNT CODE/ PRODUCT CODE	DESCRIPTION	PRICE EACH
O WHE060	17.5kW (60,000 Btu) 1.5" M/T	£412.00
O WHE100	30kW (100,000 Btu) 1.5" M/T	£454.00
O WHE130	38kW (130,000 Btu) 1.5" M/T	£496.00
O WHE170	50kW (170,000 Btu) 1.5" M/T	£526.00
O WHE230	67kW (230,000 Btu) 2" M/T	£610.00
C PPF116	1.5" Composite Union	£37.05
C PPF216	2" Composite Union	£49.85

PUMPS, FILTERS & HEATING

# Bowman Heat Exchangers



- Cupro-nickel tubes
- Plastic ends
- Non-threaded thermostat pocket
- 1.5" | 50mm unions supplied
- New EC80 model delivers up to 100kW heat transfer. 20kW is ideal for small pools and spas
- 12 month warranty

## Bowman Heat Exchangers

DISCOUNT CODE/ PRODUCT CODE	DESCRIPTION	PRICE EACH
K EC80-5113-1C	20kW (68,000 Btu)	£256.00
K EC120-5113-3C	70kW (240,000 Btu)	£403.00
K FC100-5114-2C	100kW (340,000 Btu)	£604.00

MODEL	POOL CAPACITY		HEAT TRANSFER 82°C Boiler Water		HEAT TRANSFER 60°C Boiler Water		BOILER WATER FLOW		MAXIMUM POOL WATER FLOW		WEIGHT kg
	m <sup>3</sup>	gal	kW	Btu/h	kW	Btu/h	m <sup>3</sup> /h	l/m	m <sup>3</sup> /h	l/m	
EC80-5113-1C	40	8,800	20	68,000	12	41,000	2.1	35	9.0	150	3.0
EC120-5113-3C	120	26,000	70	240,000	40	135,000	3.6	60	13.5	225	5.5
FC100-5114-2C	170	37,000	100	340,000	55	190,000	5.4	90	21.0	350	8.8



# Elecro Generation 2 Titanium Heat Exchangers



### Features and benefits

- Made in the UK
- Four models ranging from 30-kW to 122-kW
- Titanium tube bundle
- BS 316L Stainless Steel primary casing
- Salt and sea water compatible
- 4 bar pressure tolerance
- Low pressure drop
- With optional Smart Touchscreen Controller and Booster Pump
- Temperature and flow sensor port
- Floor and wall mountable
- 2 Year warranty

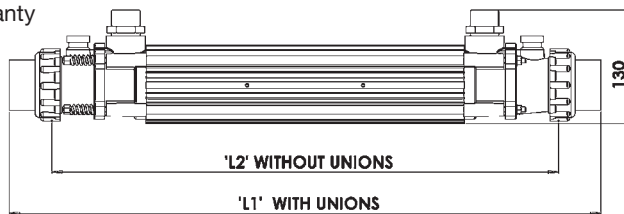

## Generation 2 Titanium Heat Exchangers

DISCOUNT CODE/ PRODUCT CODE	DESCRIPTION	PRICE EACH
H G2-HE-30T	30kW (102,000 Btu)	£363.59
H G2-HE-49T	49kW (167,000 Btu)	£449.08
H G2-HE-85T	85kW (290,000 Btu)	£550.02
H G2-HE-122T	122kW (416,000 Btu)	£768.38

Generation 2 Titanium Heat Exchangers Specifications	
<b>Flow Tube</b>	Primary Circuit: BS 316L stainless steel tube.
<b>Water Connections</b>	Primary Circuit: 1" BSP male fittings Secondary Circuit: 1.5"/50mm stepped ABS unions for rigid pipe connection.
<b>Working Pressure</b>	Primary Circuit: 4 bar maximum Secondary Circuit: 4 bar maximum

PUMPS, FILTERS & HEATING



Generation 2 Titanium Heat Exchangers Output and Dimensions			
Titanium Tube Bundle Product Code	Standard Power Output	Dimensions 'L1'	Dimensions 'L2'
G2-HE-30T	30kW (102,000 BTU)	540mm	426mm
G2-HE-49T	49kW (167,000 BTU)	710mm	596mm
G2-HE-85T	85kW (290,000 BTU)	840mm	726mm
G2-HE-122T	122kW (416,000 BTU)	1000mm	886mm

# HeatSmart Digital Controller



Elecro HeatSmart Digital Controller Data Sheet	
<b>Power Supply</b>	Single phase or 100-240V
<b>Available Models</b>	Heating Only, Cooling Only
<b>Control Thermostat</b>	Digital: 0 > 45°C (0.5°C differential)
<b>Temperature Sensor</b>	1 metre long (thermistor 103AT-2, R25=10K B=3435K)
<b>Flow Switch</b>	Gold tipped reed switch with titanium fulcrum pin
<b>Ingress Protection Rating</b>	IP44
<b>Frequency</b>	50/60 Hz
<b>Mounting</b>	Wall mounting
<b>Optional Accessories</b>	Grundfos Booster Pump

### Features and benefits

- Made in the UK
- The perfect controller for G2
- Smart touchscreen display
- BMS (Building Management System) Integration ready
- Multi-lingual interface
- Programmable-hour time clock (4 time zones)
- Flow and temperature sensor ports
- 0°C - 45°C range, accurate control to 0.5°C
- Diagnostic display
- WiFi Connectivity
- 2 Year Warranty



HeatSmart PSC-HE

## HeatSmart

DISCOUNT CODE/ PRODUCT CODE	DESCRIPTION	PRICE EACH
H PSC-HE	HeatSmart+ Touch Screen Controller w sensors	£370.80
H PSC-HE-GP	HeatSmart+ Touch Screen Controller w Grundfos Pump	£544.87

# Heat Exchanger Analogue Heating Controller



Analogue controller for heat exchanger, comes with flow switch and an optional booster pump.

## Analogue Heating Controller

DISCOUNT CODE/ PRODUCT CODE	DESCRIPTION	PRICE EACH
H HE-ANA	Supplied with 1m flow switch and 1m temp sensor 10-W	£214.24
H HE-ANA-GP	Supplied w 1m flow switch, 1m temp sensor & grundfos booster pump 90-W	£369.77



SPECIFICATIONS	
<b>Power Supply</b>	Single phase 220-240V
<b>Available Models</b>	Heating only
<b>Control Thermostat</b>	Analogue: 0 > 45°C (1.2°C differential)
<b>Temperature Sensor</b>	Capillary thermostat
<b>Flow Switch</b>	Gold tipped reed switch with titanium fulcrum pin
<b>Ingress Protection Rating</b>	IP44
<b>Frequency</b>	50/60HZ
<b>Mounting</b>	Wall Mounting

Model	Net Weight	Gross Weight	Volume	Height	Width	Depth
HE-ANA	1kg	1.6kg	0.016m³	176mm	165mm	61mm
HE-ANA-GP	2.7kg	3.5kg	0.016m³	176mm	165mm	61mm

PUMPS, FILTERS  
& HEATING

# PoolSmart Plus Digital Controller



### Features and benefits

- Made in the UK
- WiFi connectivity
- Smart touchscreen display
- BMS (Building Management System) Integration ready
- Multi-lingual interface
- Programmable 24-hour time clock (4 time zones)
- Flow and temperature sensor ports
- Accurate control to 0.5°C
- Diagnostic display
- 2 year warranty



PoolSmart PSpC-POOL

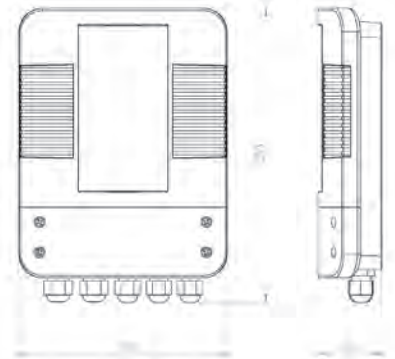

Elecro HeatSmart Digital Controller Data Sheet	
<b>Power Supply</b>	Single phase or 100-240V
<b>Available Models</b>	Heating Only
<b>Control Thermostat</b>	Digital: 0 > 45°C (0.5°C differential)
<b>Temperature Sensor</b>	3 metre long (thermistors 103AT-2, R25=10K B=3435K)
<b>Flow Switch</b>	3 metre long with gold tipped reed switch with titanium fulcrum pin
<b>Ingress Protection Rating</b>	IP44
<b>Frequency</b>	50/60 Hz
<b>Mounting</b>	Wall mounting

## PoolSmart Plus

DISCOUNT CODE/ PRODUCT CODE	DESCRIPTION	PRICE EACH
H PSpC-POOL	PoolSmart+ Touch Screen Controller w sensors and T-piece	£391.40



# Electro Nano Splasher Plug & Play Heater



### Features and benefits

- Made in the UK
- Available as 2-kW & 3-kW “Plug & Play”
- Easy installation, fully equipped and pre-wired with UK plug
- Robust, durable construction
- Ultra-reliable flow switch allows safe operation
- Supplied with temperature thermostat and overheating sensor
- Compact, durable design
- Analogue control with 1.2°C differential
- Titanium flow tube and titanium heating element
- Can be floor or vertically wall mounted
- Vortex, long life, stay clean heating element technology
- 100% efficiency throughout the product life
- Silent operation
- Supplied with water connections for flexible or rigid piping
- 2 meter cord with UK plug.
- 2 year warranty



Note: Can be mounted horizontally or vertically.

## Electro Nano Splasher Plug & Play Heater

DISCOUNT CODE/ PRODUCT CODE	DESCRIPTION	PRICE EACH
H N-AGP-UK-T2	2kW Single phase	£372.86
H N-AGP-UK-T	3kW Single phase	£380.07

### Supplied connection options:

- 1.5" female threaded
- 50mm plain female socket unions
- 1.5" plain female socket unions
- 1.5" / 1.25" hosetail connectors

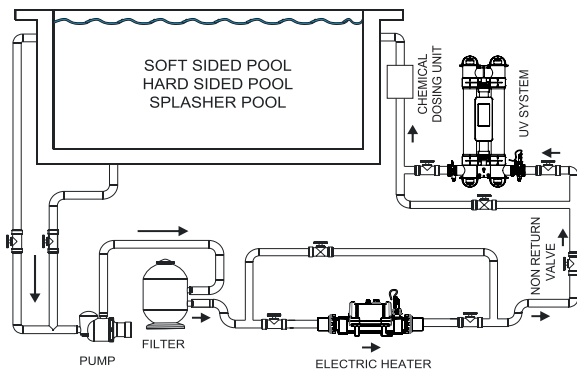

### Electro Nano Plug & Play Heater Data Sheet

Weight	50kg
Dimensions	296 x 142 x 176mm
Power Supply	220-2240V Single phase
Flow Requirements	Minimum flow: 1m³/h Maximum flow: 17m³/h
Heating Element	Grade 1 titanium
Flow Tube	Grade 1 titanium
Control Thermostat	Analogue: 0>45°C (1.2°C differential)
Safety Thermal Cut Out	60°C (manual reset)
Flow Switch	Gold tipped reed switch with titanium fulcrum pin
Relays	Surface mount DPDT Finder 66.82.8.230.0000
Seals	High temperature special formula EPDM ferrules, TPE end fitting gaskets
Water Connections	1.5" BSP female thread supplied with 1½" / 50mm stepped ABS unions for rigid pipe and 1½" / 1¼" stepped hose tails for flexible pipe
International Protection Marking	IP44
Frequency	50/60 Hz
Working Pressure	4 bar maximum
Mounting	Floor or wall mounting

PUMPS, FILTERS & HEATING

## Electro Nano Spa Heater

SPECIAL ORDER



Provides efficiency, safety and above all reliability to effortlessly heat your water to the desired temperature, the Nano Spa heater is an ideal solution for spas.

### Electro Nano Spa Heater

DISCOUNT CODE/ PRODUCT CODE	DESCRIPTION	PRICE EACH
H N-SPA-T3-R	3kW Single phase	£428.48

Note: Nano Spa models ranging from 1kW – 8kW available upon request.





# Analogue EVOLUTION 2 Heater Ti Elements



### Features and benefits

- Made in the UK
- 7 power options ranging from 3-kW to 18-kW
- Easy installation, fully equipped and pre-wired
- Robust, durable construction
- Ultra-reliable flow switch allows safe operation
- Temperature thermostat and overheating sensor
- Compact, durable design
- Analogue control with 1.2°C differential
- Titanium flow tube and titanium heating element
- Can be floor or vertically wall mounted
- Vortex, long life, stay clean heating element technology
- 100% efficiency throughout the product life
- Silent operation
- 2 year warranty
- L308 x W160 x H249mm



**Note:** This model is a direct replacement for the Evolution.

PUMPS, FILTERS & HEATING

## Analogue EVOLUTION 2 Heater Ti Elements

DISCOUNT CODE/ PRODUCT CODE	DESCRIPTION	PRICE EACH
H E2-1-3	▲ 3kW Single phase	£622.12
H E2-1-4	▲ 4.5kW Single phase	£629.33
H E2-1-6	▲ 6kW Single phase	£637.57
H E2-1-9	▲ 9kW Single phase	£687.01
H E2-1-12	▲ 12kW Single phase	£709.67
H E2-1-15	▲ 15kW Single phase	£805.46
H E2-1-18	▲ 18kW Single phase	£882.71

**Note: Larger 400v 3 Phase and digital display models available upon request.**

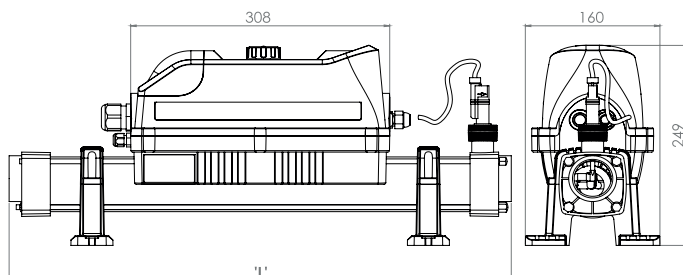
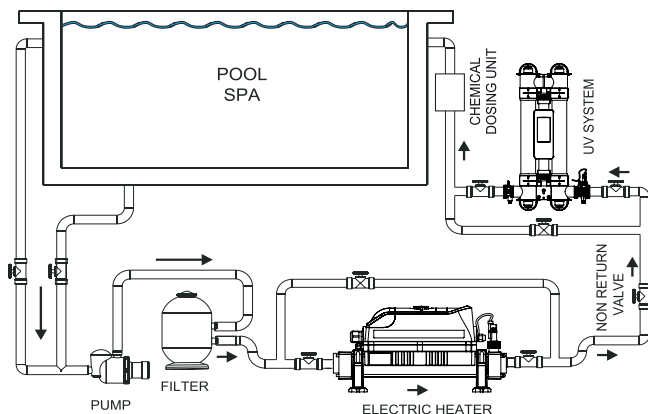

Elecro Analogue EVOLUTION 2 Heater Ti Elements Data Sheet	
<b>Power Supply</b>	Single phase or three phase
<b>Flow Requirements</b>	Minimum flow: 1-kW to 6-kW, 1m³/h Minimum flow: 9-kW to 24-kW, 4m³/h Maximum flow: 17m³/h
<b>Heating Element</b>	Grade 1 titanium
<b>Flow Tube</b>	Grade 1 titanium
<b>Control Thermostat</b>	Analogue: 0>45°C (1.2°C differential)
<b>Safety Thermal Cut Out</b>	60°C (manual reset)
<b>Flow Switch</b>	Gold tipped reed switch with titanium fulcrum pin
<b>Contactors</b>	Dual Siemens 3RT2023 or 3RT2027
<b>Seals</b>	High temperature special formula EPDM ferrules, TPE end fitting gaskets
<b>Water Connections</b>	1.5" BSP female thread supplied with 1½" / 50mm stepped ABS unions for rigid pipe and 1½" / 1¼" stepped hose tails for flexible pipe
<b>International Protection Marking</b>	IP44
<b>Frequency</b>	50/60 Hz
<b>Working Pressure</b>	4 bar maximum
<b>Mounting</b>	Floor or wall mounting

# Electro Touch Screen Optima Compact

SPECIAL ORDER



## Features and benefits

- Made in the UK
- 7 power options ranging from 3-kW to 24-kW
- Easy installation, fully equipped and pre-wired
- Robust, durable construction
- Ultra-reliable flow switch allows safe operation
- Fitted with temperature thermostat and overheating sensor
- Compact, durable design
- Touchscreen control with soft-start for power supply protection
- Titanium flow tube and titanium heating element(s)
- Can be floor or vertically wall mounted (bracket supplied)
- Vortex, long life, stay clean heating element technology
- 100% efficiency throughout the product life
- Silent operation
- 2 year warranty
- L594 x W200 x H222mm

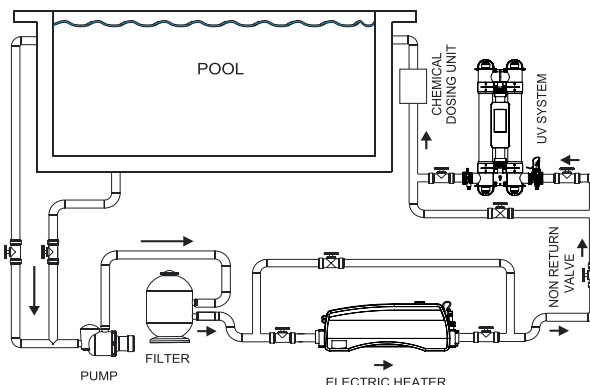

PUMPS, FILTERS & HEATING

## Touch Screen Optima Compact

DISCOUNT CODE/ PRODUCT CODE	DESCRIPTION	PRICE EACH
<b>Single phase models</b>		
H OCPD-1-3	3kW Single phase	£928.03
H OCPD-1-4	4.5kW Single phase	£947.60
H OCPD-1-6	6kW Single phase	£966.14
H OCPD-1-9	9kW Single phase	£1,013.52
H OCPD-1-12	12kW Single phase	£1,034.12
H OCPD-1-15	15kW Single phase	£1,220.55
H OCPD-1-18	18kW Single phase	£1,289.56

<b>Three phase models</b>		
H OCPD-V-6	6kW Versatile Single phase or 3 phase	£1,153.60
H OCPD-V-9	9kW Versatile Single phase or 3 phase	£1,176.26
H OCPD-V-12	12kW Versatile Single phase or 3 phase	£1,198.92
H OCPD-3-15	15kW 3 phase	£1,221.58
H OCPD-3-18	18kW 3 phase	£1,288.53
H OCPD-3-24	24kW 3 phase	£1,326.64



## Electro Touch Screen Optima Compact Data Sheet

<b>Power Supply</b>	Single phase or three phase
<b>Flow Requirements</b>	Minimum flow: 2-kW to 6-kW, 1m³/h Minimum flow: 9-kW to 24-kW, 4m³/h Maximum flow: 17m³/h
<b>Heating Element</b>	Grade 1 titanium
<b>Flow Tube</b>	Grade 1 titanium
<b>Control Thermostat</b>	Touch Screen 0 > 45°C (0.5°C differential)
<b>Safety Thermal Cut Out</b>	60°C (manual reset)
<b>Flow Switch</b>	Gold tipped reed switch with titanium fulcrum pin
<b>Contactors</b>	Dual Siemens 3RT2023 or 3RT2027
<b>Seals</b>	High temperature special formula EPDM ferrules, TPE end fitting gaskets
<b>Water Connections</b>	1.5" BSP female thread supplied with 1½" / 50mm stepped ABS unions for rigid pipe and 1½" / 1¼" stepped hose tails for flexible pipe
<b>International Protection Marking</b>	IP44
<b>Frequency</b>	50/60 Hz
<b>Working Pressure</b>	4 bar maximum
<b>Mounting</b>	Floor or wall mounting

## Electro Titan Optima

SPECIAL ORDER



Reliable accurate and efficient, the Titan Optima fully titanium heater is top of the range and comes with a touchscreen display. It is the ideal choice for a long-lasting heater for commercial pools. The design makes it highly robust and durable.

**Note: Titan Optima models ranging from 10kW – 18kW available upon request.**

# HeatSeeker® Inverter Heat Pumps

PALLET

- Durable ABS Shell
- R32 Refrigerant
- Low start up current
- No soft start required
- Ultra quiet operation
- Simple to use digital controller
- Quick and easy operation
- Fully programmable
- Titanium Heat exchanger



HSI210

The new 2020 HSI range of Heatseeker heatpumps have been developed to compete at the top end of the heatpump market.

From the same manufacturer as the original "Heatseeker" you can expect the same level of reliability and support associated with Plastica's well established brand/range.

The inverter technology increases efficiency, whilst drastically reducing start up current and will no longer require an additional soft start fitted.

Model	Voltage	Fuse (A)	Running Current	Noise	Net Weight	Optimum Flow	Rated Heating Capacities	Maximum Pool Volume
HSI078	220-240 (1ph)	13	5.5 - 2.6a	52-50-46dB	48kg	3.4m³/h	8.02 - 4.09kW	25m³
HSI125	220-240 (1ph)	16	11.18 - 4.99a	58-47dB	49kg	5.4m³/h	12.64 - 7.86kW	50m³
HSI170	220-240 (1ph)	25	15.41 - 5.15a	58-52dB	64kg	7.3m³/h	16.4 - 7.54kW	70m³
HSI210	220-240 (1ph)	32	17.82 - 7.5a	58-52dB	89kg	9.0m³/h	23.48 - 13.28kW	85m³

## HeatSeeker® Covers

DISCOUNT CODE/ PRODUCT CODE	DESCRIPTION	PRICE EACH
K HCH100	Winter Cover for Horizontal HeatSeeker for HSE Models	£85.00
K HCV100	Winter Cover for Vertical HeatSeeker for HSE Models	£88.00
K HCH078	Winter Cover for 7.8kW inverter Heatseeker	£85.00
K HCH112	Winter Cover 12.5kw Inverter HeatSeeker	£85.00
K HCH117	Winter Cover 17kw Inverter HeatSeeker	£85.00
K HCH121	Winter Cover 21kw Inverter HeatSeeker	£85.00
K HSE500	HeatSeeker Bypass Kit	£78.70

Recommended maximum pool volume for HeatSeekers.

This sizing chart assumes that a pool is being heated from May to September, the desired pool temperature is 29°C, the ambient air temperature is not less than 15°C and a heat retention cover is used. Although the HSI Range remains efficient down to 7°C.

**i** It is strongly recommended that checks are made in relation to starting amps and load requirements for these machines.



## HSI078 HeatSeeker®

DISCOUNT CODE/ PRODUCT CODE	DESCRIPTION	PRICE EACH
H2 HSI078	7.8kW Inverter Heat Pump	£1,428.00

### HSI078 Dimensions

Height	Width	Depth
585	990 (with controller)	320

## HSI125 HeatSeeker®

DISCOUNT CODE/ PRODUCT CODE	DESCRIPTION	PRICE EACH
H2 HSI125	12.5kW Inverter Heat Pump	£1,956.00

### HSI125 Dimensions

Height	Width	Depth
620	1035 (with controller)	330

# HeatSeeker® Inverter Heat Pumps

PALLET



## HSI170 HeatSeeker®

DISCOUNT CODE/ PRODUCT CODE	DESCRIPTION	PRICE EACH
H2   HSI170	17kW Inverter Heat Pump	£3,073.00

### HSI170 Dimensions

Height	Width	Depth
715	1100 (with controller)	380

## HSI210 HeatSeeker®

DISCOUNT CODE/ PRODUCT CODE	DESCRIPTION	PRICE EACH
H2   HSI210	21kW Inverter Heat Pump	£3,654.00

### HSI210 Dimensions

Height	Width	Depth
955	1100 (with controller)	420

PUMPS, FILTERS  
& HEATING

HeatSeekers come with a 2 year parts warranty. 5 years warranty on the Titanium Heat Exchanger. 12 months parts only warranty on all units sold out of the UK mainland.

HeatSeeker is a registered trademark of Plastica Ltd.

# HeatSeeker® AG Mini Heat Pump

## HeatSeeker® AG Mini Heat Pump

DISCOUNT CODE/ PRODUCT CODE	DESCRIPTION	PRICE EACH
H2   AGMINI	HeatSeeker AG Mini Swimming Pool Heater	£445.00
H2   AGMCK	Conversion Kit from 1" to 1.5" connection	£8.85
K   HCH101	Heat Pump Cover	£42.50

- AG Mini are the ideal choice for heating above ground pools up to 18 cubic metres
- They are light and easy to install being plug and play with an inline RCD breaker
- They are supplied with 1" connections and a conversion kit is available for 1.5"
- You get up to 2.9 Kw of Rated Heating Capacity for input power of only 0.59KW
- Weight 23kg

### AG MINI Dimensions

Height	Width	Depth
439	350	390



## Solar Pod™

- For above ground pools
- Compact size of 580mm x 580mm
- Coil made of strong polypropylene
- Strong transparent polycarbonate dome
- Easy connection
- Connect multiple units for larger pools
- Works with existing pool pump
- Minimal tools required (Philips screwdriver and silicon lubricant)
- Tilts to achieve best angle for sun
- No servicing required (other than winterising)



- Solar Pod includes:
- 1m and 0.36m hoses
  - Main base with stand
  - 1.25" to 1.5" hose reducer
  - Collared tube adaptor
  - Hose clamps
  - Side hose connector x2
  - Hose ID 38mm
  - Clear dome
  - Solar protection cover



PUMPS, FILTERS  
& HEATING

### Solar Pods™

DISCOUNT CODE/ PRODUCT CODE	DESCRIPTION	PRICE EACH
K POD001	• Solar Pod	£118.00
K POD051	• Solar Pod Accessories Kit	£16.00
K POD053	• Additional Hose (Short - 375mm x 1.5")	£8.50
K POD054	• Additional Hose (Long - 975mm x 1.5")	£17.80

**Note:** For use with Intex standard filtration you will need to purchase an Intex 1.5" hose 29060 (see page 76).

The heating efficiency of Solar Pods is directly related to climatic conditions. Plastica cannot guarantee that solar heating will maintain a constant pool temperature and recommend installation of a primary heat source.



Solar Pod Accessories Kit – POD051

**Note:** Any more than 3 Solar Pods should be plumbed in parallel.

## Solar Pod™ Plus

- For above ground pools up to 9,000 litres
- 780mm x 780mm x 450mm
- Coil made of strong polypropylene
- Strong transparent dual polycarbonate domes
- Easy connection
- Connect multiple units for larger pools
- Works with existing pool pump
- Minimal tools required (Philips screwdriver and silicon lubricant)
- Tilts to achieve best angle for sun
- No servicing required (other than winterising)
- Reflective underside for optimum heat gain



- Solar Pod Plus includes:
- Hose ID 38mm
  - Main base with stand
  - 1.25" to 1.5" hose reducer
  - Collared tube adaptor
  - Hose clamps
  - 1m and 0.36m hoses
  - Side hose connector x2
  - Clear dome
  - Solar protection cover



### Solar Pods™ Plus

DISCOUNT CODE/ PRODUCT CODE	DESCRIPTION	PRICE EACH
K POD002	• Solar Pod Plus	£278.00
K POD052	• Solar Pod Plus Accessories Kit	£16.00
K POD053	• Additional Hose (Short - 375mm x 1.5")	£8.50
K POD054	• Additional Hose (Long - 975mm x 1.5")	£17.80



Solar Pod Plus Accessories Kit – POD052

**Note:** The heating efficiency of Solar Pods is directly related to climatic conditions.

Plastica cannot guarantee that solar heating will maintain a constant pool temperature and recommend installation of a primary heat source.

# Pool Surround





# Hand Finished Bullnosed Copings

SPECIAL ORDER

HEAVY ITEM

- Kits or individual stones
- White or buff
- Joint mix included with kits

**Note:** Damaged stones must be reported within 24 hours of delivery.

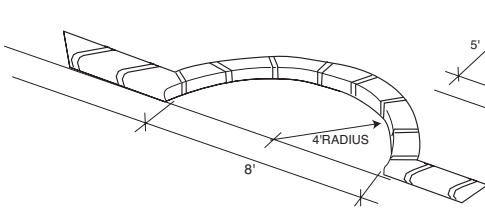
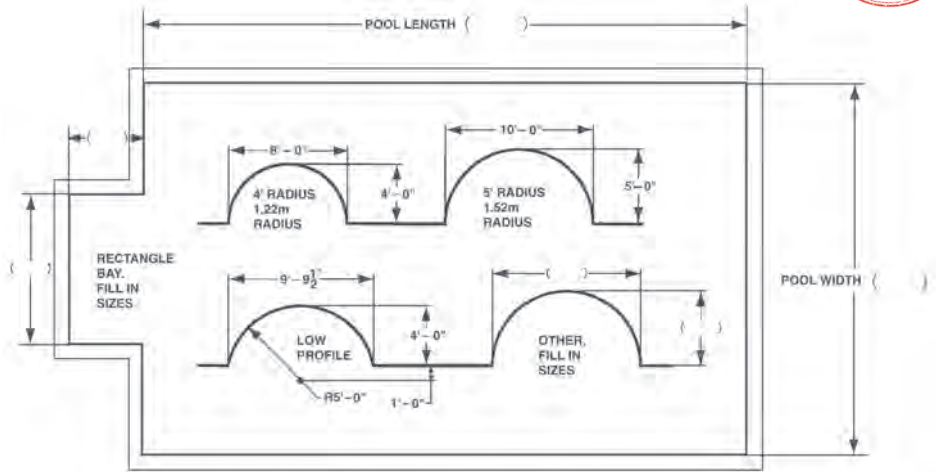

8FT ROMAN END

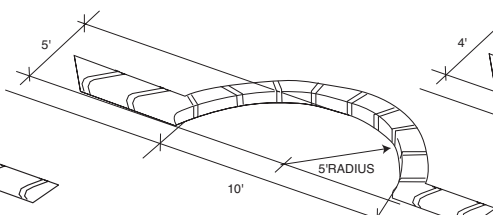

10FT ROMAN END

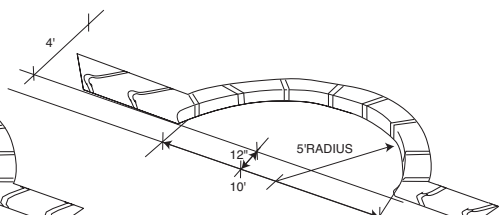

10FT LOW PROFILE ROMAN END

POOL SURROUND

**Delivery Charge:** £95.00 per pallet.

Kits 14' x 28' and over and kits with Roman Ends are delivered on 2 pallets.

For Individual stones or smaller quantities please obtain a quote from Customer Services.

**Note:** Damaged or missing stones must be reported within 24 hours of delivery.



# Hand Finished Bullnosed Copings

**SPECIAL ORDER** **HEAVY ITEM**

**Note:** Roman End and Stair Kit prices quoted are based on 4' x 6' Roman End.

**Note:** Please state square or radius corners when ordering Kits.

## 9" Bullnosed Coping Kits

DISCOUNT CODE/ PRODUCT CODE	DESCRIPTION	PRICE EACH
Q SCN210	▲ 10' x 20'	£805.63
Q SCN212	▲ 12' x 24'	£939.87
Q SCN214	▲ 14' x 28'	£1,074.11
Q SCN215	▲ 15' x 30'	£1,141.23
Q SCN216	▲ 16' x 32'	£1,208.35
Q SCN217	▲ 16' x 38'	£1,342.59
Q SCN218	▲ 18' x 36'	£1,342.59
Q SCN220	▲ 20' x 40'	£1,476.83

## 12" Bullnosed Coping Kits

DISCOUNT CODE/ PRODUCT CODE	DESCRIPTION	PRICE EACH
Q SCT210	▲ 10' x 20'	£1,013.09
Q SCT212	▲ 12' x 24'	£1,182.85
Q SCT214	▲ 14' x 28'	£1,352.61
Q SCT215	▲ 15' x 30'	£1,437.49
Q SCT216	▲ 16' x 32'	£1,522.37
Q SCT217	▲ 16' x 38'	£1,692.13
Q SCT218	▲ 18' x 36'	£1,692.13
Q SCT220	▲ 20' x 40'	£1,861.89

## 9" Bullnosed Coping Kit & Stair

DISCOUNT CODE/ PRODUCT CODE	DESCRIPTION	PRICE EACH
Q SCN312	▲ 12' x 24'	£1,135.49
Q SCN314	▲ 14' x 28'	£1,269.73
Q SCN315	▲ 15' x 30'	£1,336.85
Q SCN316	▲ 16' x 32'	£1,403.97
Q SCN317	▲ 16' x 38'	£1,538.21
Q SCN318	▲ 18' x 36'	£1,538.21
Q SCN320	▲ 20' x 40'	£1,672.45

**Note:** Please state size of Stair or Roman End and if Low Profile when ordering.

## 12" Bullnosed Coping Kit & Stair

DISCOUNT CODE/ PRODUCT CODE	DESCRIPTION	PRICE EACH
Q SCT312	▲ 12' x 24'	£1,432.03
Q SCT314	▲ 14' x 28'	£1,269.73
Q SCT315	▲ 15' x 30'	£1,686.67
Q SCT316	▲ 16' x 32'	£1,771.55
Q SCT317	▲ 16' x 38'	£1,941.31
Q SCT318	▲ 18' x 36'	£1,941.31
Q SCT320	▲ 20' x 40'	£2,111.07

**Note:** Please state size of Stair or Roman End and if Low Profile when ordering.

## 9" Bullnosed Coping Kit & Roman End

DISCOUNT CODE/ PRODUCT CODE	DESCRIPTION	PRICE EACH
Q SCN412	▲ 12' x 24'	£1,066.80
Q SCN414	▲ 14' x 28'	£1,201.04
Q SCN415	▲ 15' x 30'	£1,268.16
Q SCN416	▲ 16' x 32'	£1,335.28
Q SCN417	▲ 16' x 38'	£1,469.52
Q SCN418	▲ 18' x 36'	£1,469.52
Q SCN420	▲ 20' x 40'	£1,603.76

**Note:** All kits include Joint Mix.

## 12" Bullnosed Coping Kit & Roman End

DISCOUNT CODE/ PRODUCT CODE	DESCRIPTION	PRICE EACH
Q SCT412	▲ 12' x 24'	£1,347.39
Q SCT414	▲ 14' x 28'	£1,517.15
Q SCT415	▲ 15' x 30'	£1,602.03
Q SCT416	▲ 16' x 32'	£1,686.91
Q SCT417	▲ 16' x 38'	£1,856.67
Q SCT418	▲ 18' x 36'	£1,856.67
Q SCT420	▲ 20' x 40'	£2,026.43

**Note:** All kits include Joint Mix.

## 9" Bullnosed Copings

DISCOUNT CODE/ PRODUCT CODE	DESCRIPTION	PRICE EACH
Q SCN100	▲ 9" x 2' Straight	£22.38
Q SCN105	▲ Radius Internal Corner	£26.53
SCN107	No longer available (cut down SCT107)	
Q SCN108	▲ Square External Corner	£26.53
Q SCN110	▲ Square Internal Corner	£26.53
Q SCN115	▲ Roman End Starter L/H or R/H	£26.53
Q SCN116	▲ Roman End Low Profile Starter L/H or R/H	£26.53
Q SCN120	▲ Roman End 5' Internal Radius (8 required)	£26.53
Q SCN125	▲ Square Stair External Corner	£26.53
Q SCN130	▲ Roman End 4' internal radius (7 required)	£26.53

## 12" Bullnosed Copings

DISCOUNT CODE/ PRODUCT CODE	DESCRIPTION	PRICE EACH
Q SCT100	▲ 12" x 2 Straight	£28.29
Q SCT105	▲ Radius Internal Corner	£34.00
Q SCT107	▲ Radius External Corner	£34.00
Q SCT108	▲ Square External Corner	£34.00
Q SCT110	▲ Square Internal Corner	£34.00
Q SCT115	▲ Roman End Starter L/H or R/H	£34.00
Q SCT116	▲ Roman End Low Profile Starter L/H or R/H	£34.00
Q SCT120	▲ Roman End 5' Internal Radius (8 required)	£34.00
Q SCT125	▲ Square Stair External Corner	£34.00
Q SCT130	▲ Roman End 4' internal radius (7 required)	£34.00

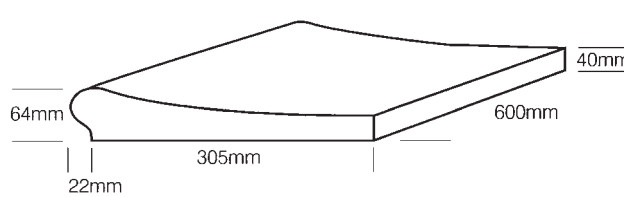
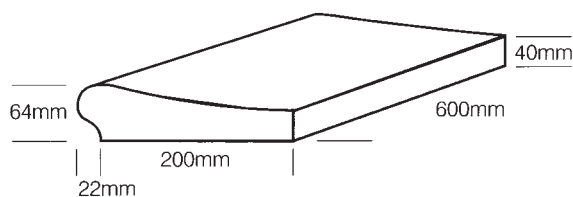

POOL SURROUND

**SPECIAL ORDER**  
**HEAVY ITEM**

# Hand Finished 9" Flat Topped Copings



2' Straight



6" Radius Corner and External Radius



Square Internal and External Corner



Roman End Radius and Starter

## 9" Flat Topped Copings

DISCOUNT CODE/ PRODUCT CODE	DESCRIPTION	PRICE EACH
Q SCF210	▲ 10' x 20'	£1,296.03
Q SCF212	▲ 12' x 24'	£1,494.08
Q SCF214	▲ 14' x 28'	£1,748.72
Q SCF215	▲ 15' x 30'	£1,861.89
Q SCF216	▲ 16' x 32'	£1,975.07
Q SCF217	▲ 16' x 38'	£2,201.41
Q SCF218	▲ 18' x 36'	£2,201.41
Q SCF220	▲ 20' x 40'	£2,427.76



## 9" Flat Topped Coping Kit & Stairs

DISCOUNT CODE/ PRODUCT CODE	DESCRIPTION	PRICE EACH
Q SCF312	▲ 12' x 24'	£1,828.13
Q SCF314	▲ 14' x 28'	£2,054.48
Q SCF315	▲ 15' x 30'	£2,167.65
Q SCF316	▲ 16' x 32'	£2,280.83
Q SCF317	▲ 16' x 38'	£2,507.17
Q SCF318	▲ 18' x 36'	£2,509.07
Q SCF320	▲ 20' x 40'	£2,733.52

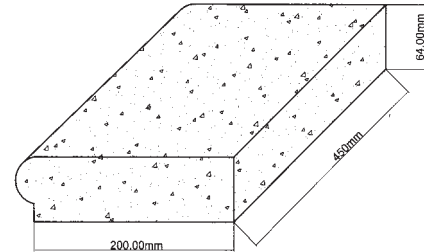

## 9" Flat Topped Coping Kit & Roman End

DISCOUNT CODE/ PRODUCT CODE	DESCRIPTION	PRICE EACH
Q SCF412	▲ 12' x 24'	£1,862.61
Q SCF414	▲ 14' x 28'	£2,088.96
Q SCF415	▲ 15' x 30'	£2,202.13
Q SCF416	▲ 16' x 32'	£2,315.31
Q SCF417	▲ 16' x 38'	£2,541.65
Q SCF418	▲ 18' x 36'	£2,541.65
Q SCF420	▲ 20' x 40'	£2,768.00

**Note:** All kits include Joint Mix

## 9" Flat Topped Copings

DISCOUNT CODE/ PRODUCT CODE	DESCRIPTION	PRICE EACH
Q SCF100	▲ 9" x 18" Straight	£28.29
Q SCF105	▲ Radius Internal Corner	£34.00
Q SCF107	▲ Radius External Corner	£34.00
Q SCF108	▲ Square External Corner	£34.00
Q SCF110	▲ Square Internal Corner	£34.00
Q SCF115	▲ Roman End Starter L/H or R/H	£34.00
Q SCF116	▲ Roman End Low Profile Starter L/H or R/H	£34.00
Q SCF120	▲ Roman End 5' Internal Radius (8 required)	£34.00
Q SCF125	▲ Square Stair External Corner	£34.00
Q SCF130	▲ Roman End 4' Internal Radius (7 required)	£34.00

**Delivery Charge:** £95.00 per pallet.

Kits over 14' x 28' and Kits with Roman Ends are delivered on two pallets.

For Individual stones or smaller quantities please obtain a quote from Customer Services.

**Note:** Damaged or missing stones must be reported within 24 hours of delivery.

POOL SURROUND

# Mini Coping Tile

SPECIAL ORDER HEAVY ITEM

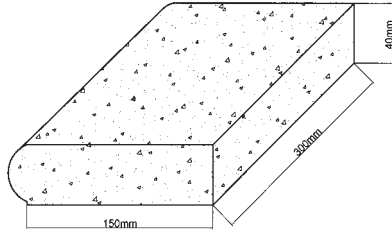

## Mini Indoor Copings

DISCOUNT CODE/ PRODUCT CODE	DESCRIPTION	PRICE EACH
Q SCM100	▲ Straight	£17.73
Q SCM105	▲ Internal Corner	£20.70
Q SCM110	▲ External Corner	£20.70
Q SCM115	▲ Starter L/H or R/H	£20.70
Q SCM116	▲ Roman End Low Profile Starter L/H or R/H	£20.70
Q SCM120	▲ Roman End 5' Internal Radius (16 required)	£20.70
Q SCM130	▲ Roman End 4' Internal Radius (14 required)	£20.70

## Joint Mix

DISCOUNT CODE/ PRODUCT CODE	DESCRIPTION	PRICE EACH
Q SCN150	Suitable for pools up to 4m x 8m (14' x 28')	£28.29

**Delivery Charge:** £95.00 per pallet.

Kits over 14' x 28' and Kits with Roman Ends are delivered on two pallets.

For Individual stones or smaller quantities please obtain a quote from Customer Services.

**Note:** Damaged or missing stones must be reported within 24 hours of delivery.

POOL SURROUND

# Easy Drain Plus



- Removable top section for ease of access
- Made to standard coping height 68mm
- Rigid PVC
- Made for 1.5" pipework
- 3m length of Easy Drain requires 3 nailing clips

## Easy Drain Plus

DISCOUNT CODE/ PRODUCT CODE	DESCRIPTION	PRICE EACH
G3 PED100	3m Lengths (A)	£56.50
G3 PED110	End Caps (B)	£5.20
G3 PED105	Couplers (C)	£2.70
G3 PED145	Nailing Clips - 3 req per length, for securing level (D)	£1.45
G3 PED130	Cross Piece (E)	£43.90
G3 PED120	90° Angle (F)	£21.50
G3 PED125	Tee Piece (G)	£38.85
G3 PED115	135° Angle (H)	£21.50
G3 PED135	Downspout 1.5" - 38mm diameter UK (I)	£14.45
G3 PED535	Downspout - 50mm diameter Europe	£14.45
K EDT100	Easy Drain Top Cover - 3m lengths	£10.50

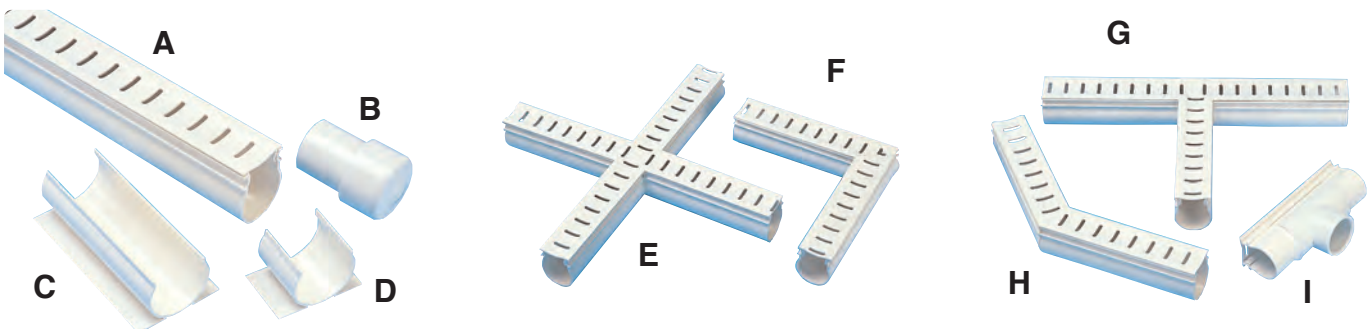
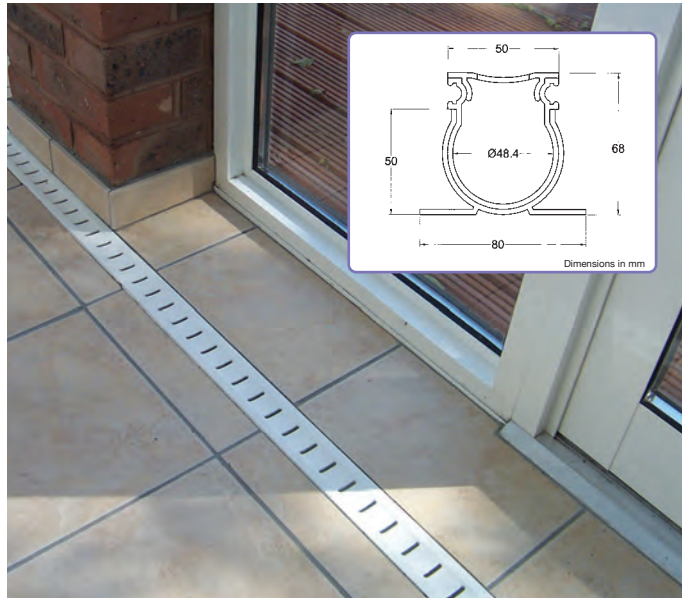



# 1.7"/43mm Standard Ladders

- 316 stainless steel tube
- Suitable for salt water
- 1.7" diameter
- Double top treads
- Stainless steel anti-slip treads
- Suitable for concrete and liner pools



C/C - centre to centre  
O/A - overall

All Plastica 43mm Pool Ladders are made to conform to BS EN 13451-1 and are supplied with a double top tread to enable installation to BS EN 13451-2.

## 1.7"/43mm Standard Set

DISCOUNT CODE/ PRODUCT CODE	DESCRIPTION	PRICE EACH
D PSL432S	2-Tread	£485.00
D PSL433S	3-Tread	£527.00
D PSL434S	4-Tread	£598.00
D PSL435S	5-Tread	£665.00

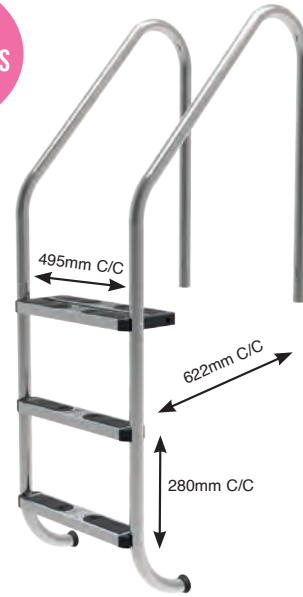

## 1.7"/43mm Standard with Flanges Set

DISCOUNT CODE/ PRODUCT CODE	DESCRIPTION	PRICE EACH
D PSL432FS	2-Tread with Flange fittings	£585.00
D PSL433FS	3-Tread with Flange fittings	£627.00
D PSL434FS	4-Tread with Flange fittings	£698.00
D PSL435FS	5-Tread with Flange fittings	£765.00

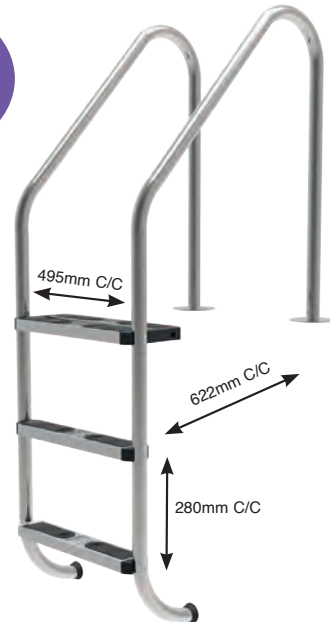

## 1.7"/43mm Double Flanged Ladder

DISCOUNT CODE/ PRODUCT CODE	DESCRIPTION	PRICE EACH
D PSL432DF	2-Tread D/F Standard Ladder 316 grade	£685.00
D PSL433DF	3-Tread D/F Standard Ladder 316 grade	£727.00
D PSL434DF	4-Tread D/F Standard Ladder 316 grade	£798.00
D PSL435DF	5-Tread D/F Standard Ladder 316 grade	£865.00

**Note:** These ladders are recommended for heavily used pools.



POOL SURROUND



## 1.7"/43mm Peg type Ladder

- 316 stainless steel tube
- Suitable for salt water
- 1.7" diameter
- Double top treads
- Stainless steel anti-slip treads
- Suitable for concrete and liner pools



All Plastica 43mm Pool Ladders are made to conform to BS EN 13451-1 and are supplied with a double top tread to enable installation to BS EN 13451-2.

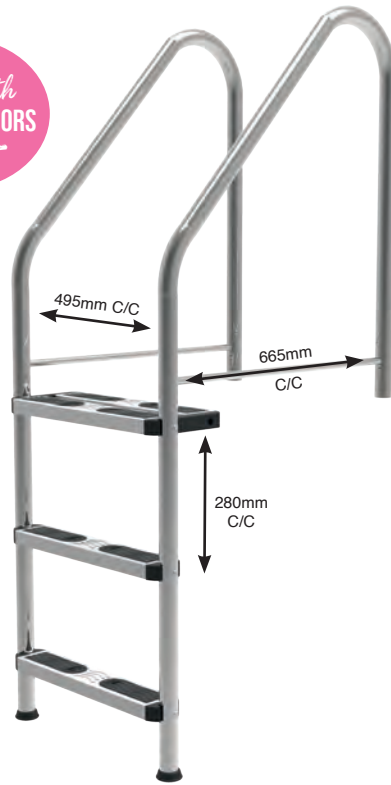

### 1.7"/43mm Peg Type

DISCOUNT CODE/ PRODUCT CODE	DESCRIPTION	PRICE EACH
D PSL433PS	3-Tread	£583.00
K ESC043	Flange cover plate 43mm	£19.80

**Note:** Ladder hinges and sleeve flanges cannot be used with peg type ladders.

POOL SURROUND

## 1.7"/43mm Undercover



All Plastica 43mm Pool Ladders are made to conform to BS EN 13451-1 and are supplied with a double top tread to enable installation to BS EN 13451-2.

- 316 stainless steel tube
- Suitable for salt water
- 1.7" diameter
- Double top treads
- Stainless steel anti-slip treads
- Suitable for concrete and liner pools

### Undercover

DISCOUNT CODE/ PRODUCT CODE	DESCRIPTION	PRICE EACH
D PSL432US	2-Tread	£409.00
D PSL433US	3-Tread	£461.00
D PSL434US	4-Tread	£517.00
D PSL435US	5-Tread	£609.00

### Grab Rails

DISCOUNT CODE/ PRODUCT CODE	DESCRIPTION	PRICE EACH
D PSL430F	With Flange (each)	£335.00
D PSL430A	With Anchor (each)	£236.00
K ESC043	Flange Cover Plate to suit PSL430A (each)	£19.80

**Note:** You will need to select which grab rails you require from above.

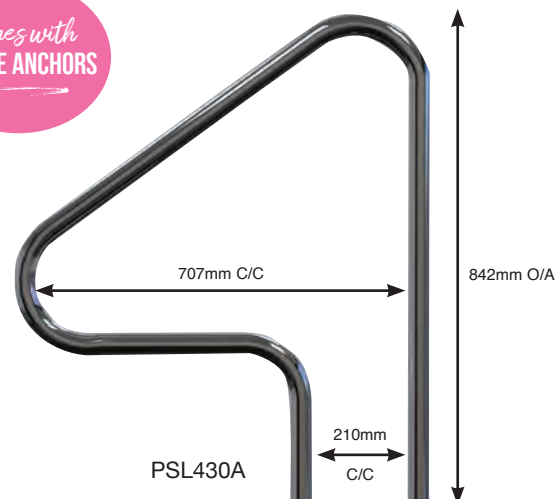

MADE TO ORDER



## 1.7"/43mm Slimline Ladders

- 316 stainless steel tube
- Suitable for salt water
- 1.7" diameter
- Double top treads
- Stainless steel anti-slip treads
- Suitable for concrete and liner pools

All Plastica 43mm Pool Ladders are made to conform to BS EN 13451-1 and are supplied with a double top tread to enable installation to BS EN 13451-2.

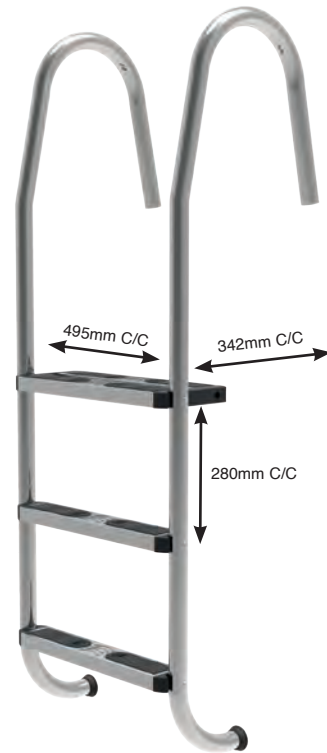

### 1.7"/43mm Slimline Ladders

DISCOUNT CODE/ PRODUCT CODE	DESCRIPTION	PRICE EACH
D PSL432SS	2-Tread	£500.00
D PSL433SS	3-Tread	£552.00
D PSL434SS	4-Tread	£611.00
D PSL435SS	5-Tread	£667.00

MADE TO ORDER



## 1.7"/43mm Wooden Pool Ladder

- 316 stainless steel tube
- Suitable for any depth of pool
- Easily removable for cover installation

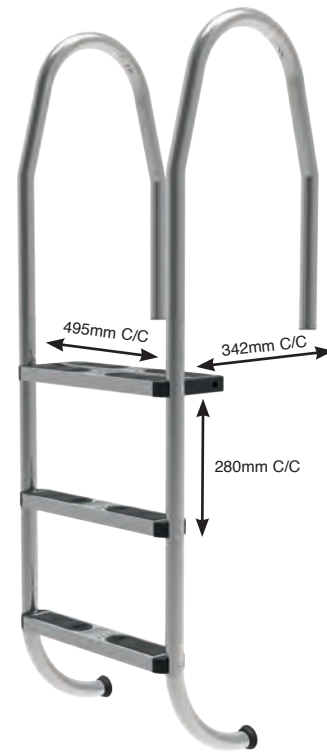

### 1.7"/43mm Wooden Pool Ladder

DISCOUNT CODE/ PRODUCT CODE	DESCRIPTION	PRICE EACH
D PSL436RWS	3-Tread	£714.00
K ESC043	Flange Cover Plate	£19.80



PSL436RWS Removable Ladder

MADE TO ORDER



POOL SURROUND



## 1.7"/43mm Decking Ladder

- 316 stainless steel adjustable ladder
- 48-52" depth pools
- Level of decking can be up to 0.2m below top of pool
- Stainless steel sliding flange adjusts height

### 1.7"/43mm Decking Ladder

DISCOUNT CODE/ PRODUCT CODE	DESCRIPTION	PRICE EACH
D PSL434DS	43mm 4-Tread Decking Ladder	£722.00

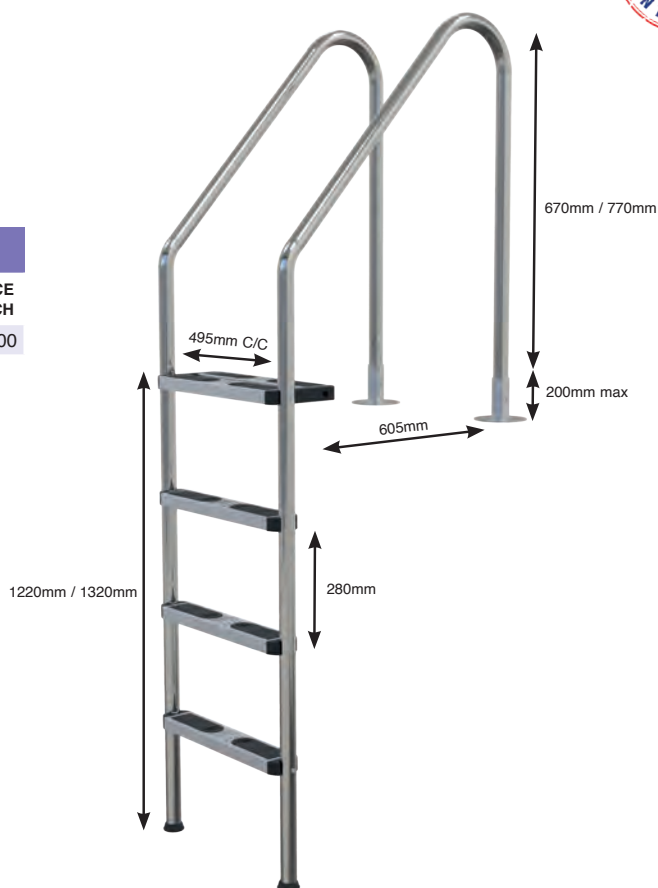

POOL  
SURROUND

## 1.5"/38mm Ladders

- 304 stainless steel tube
- 1.5" diameter
- White ABS treads, ribbed underside for strength
- 2 to 5-tread models available
- Undercover ladders and Gibraltar Grab Rails for pools or spas
- Made to measure ladder quotes available
- Ladder kits contain compression anchors, fixing kit and cushions



## 1.5"/38mm Standard Ladders

### Standard Set

DISCOUNT CODE/ PRODUCT CODE	DESCRIPTION	PRICE EACH
D PSL105	2-Tread	£506.00
D PSL110	3-Tread	£543.00
D PSL115	4-Tread	£549.00
D PSL120	5-Tread	£615.00

**Note:** During 2013, the reversal bend on standard, slim line, undercover and wooden pool ladders was modified to decrease the distance between the ladder treads and the pool wall. This has been done to assist the prevention of the entrapment risk as highlighted in SPATA and European standards.





# 1.5"/38mm Liner Peg Type

## Liner Peg Set

DISCOUNT CODE/ PRODUCT CODE	DESCRIPTION	PRICE EACH
D PSL700	3-Tread	£558.00
K ESC001	Cover Plate	£18.85

**Note:** Ladder hinges and sleeve flanges cannot be used with peg type ladders.



POOL SURROUND

# 1.5"/38mm Undercover Ladders

MADE TO ORDER



## Grab Rails

DISCOUNT CODE/ PRODUCT CODE	DESCRIPTION	PRICE EACH
D PSL305	With Flange (each)	£331.00
D PSL402	With Compression Anchor (each)	£203.00
K ESC010	Flange Cover Plate to suit PSL305 (each)	£19.98

## Undercover

DISCOUNT CODE/ PRODUCT CODE	DESCRIPTION	PRICE EACH
D PSL405	2-Tread	£378.00
D PSL410	3-Tread	£417.00
D PSL415	4-Tread	£484.00
D PSL420	5-Tread	£517.00

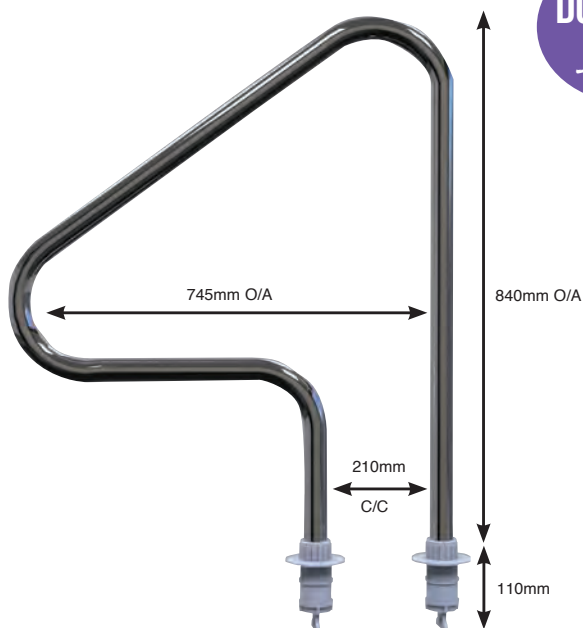



# Ladder Accessories

## ABS Treads

DISCOUNT CODE/ PRODUCT CODE	DESCRIPTION	PRICE EACH
K PSL10004	38mm, 475mm wide	£23.68



ABS Tread - PSL10004

## New 495mm length Stainless Steel Treads

DISCOUNT CODE/ PRODUCT CODE	DESCRIPTION	PRICE EACH
K TRD043SC	43mm, Single Tread Depth, L495 x D80 x H30mm	£58.00
K TRD043DC	43mm, Double Tread Depth, L495 x D190 x H30mm	£93.00

**Note:** Stainless Steel Ladder Treads are not interchangeable with ABS Treads.



L495mm C/C  
Stainless Single Tread



L495mm C/C  
Stainless Double Tread

## Hinges

DISCOUNT CODE/ PRODUCT CODE	DESCRIPTION	PRICE EACH
K PLH500	1.5" (38mm)	£298.00
K PLH430	1.7" (43mm)	£411.00

## Anchors

DISCOUNT CODE/ PRODUCT CODE	DESCRIPTION	PRICE EACH
K PSL10001	38mm Compression Anchor (single)	£12.30
K WEA001C	43mm Wedge Anchor (single)	£10.50
S HD10P	38mm Pinch Anchor Set (pair)	£27.90

## Flanges

DISCOUNT CODE/ PRODUCT CODE	DESCRIPTION	PRICE EACH
K ESC001	Cover Plate to suit PSL600 & PSL700	£18.85
K ESC043F	Cover Plate for 43mm Flanged Ladders/Handrails - ø130mm Flange	£19.80
K ESC043	Cover Plate to suit 127mm (5") dia Flange	£19.80
K ESC010	Cover Plate to suit 38mm Flanged Ladders/ Handrails - ø130mm Flange	£19.98
D PSL157	Sleeve Flange Kit (38mm)	£148.00
D PSL437	Sleeve Flange Kit (43mm)	£158.00



**Note:** The 475mm length on both single and double Stainless Steel Treads has now been replaced with 495mm length, in line with current SPATA Standards.

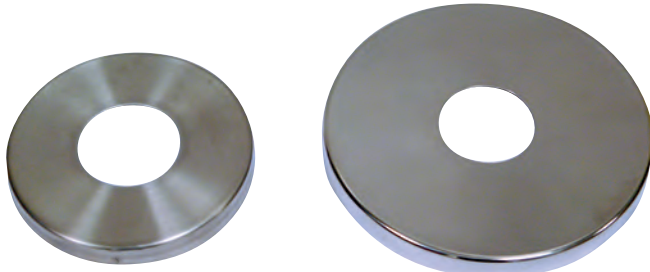

Flange Cover Plates - ESC001 & ESC010

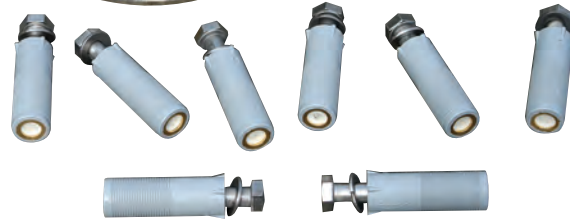
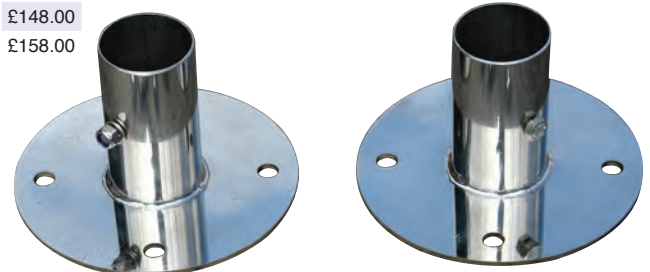

Sleeve Flange Kit - PSL157/PSL437

**Note:** ESC010 will not fit PSL157 Kit.



Hinges - PLH500



Compression Anchor - PSL10001



Pinch Anchors (pair) - HD10P

POOL  
SURROUND

# Handrail Products

- Grade 304 or 316 stainless steel Handrail
- Plastic connectors
- 3m lengths of 1.25" (32mm) diameter tube
- Stainless steel or ABS brackets

Top Fixings – PHR303

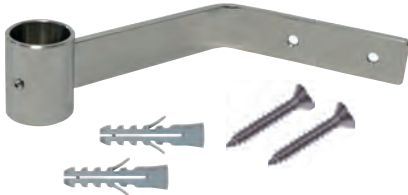

Top Fixing Handrail (DOMESTIC ONLY)  
(fixings sold separately – PHR521)

Dimensions for Top Fixing Handrail

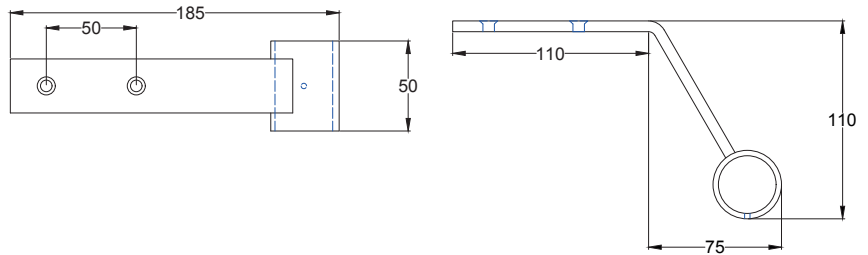

SS Handrail Brackets – PHR302/PHR301

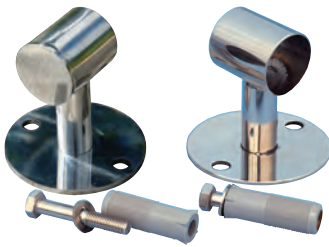

Stainless Steel Brackets & Fixings  
(fixings sold separately – PCR00020  
\*16mm drill bit required)

Dimensions for stainless steel 1.25" (32mm) Handrail Bracket

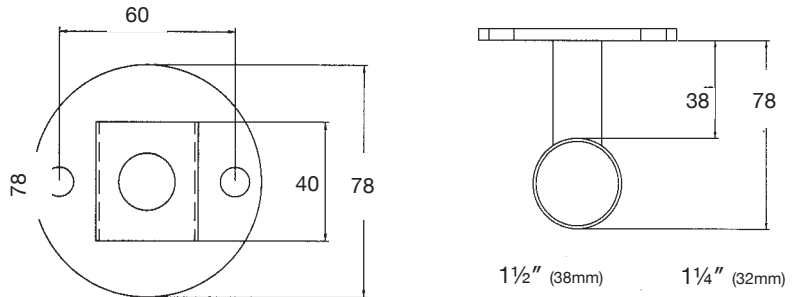

ABS Handrail Brackets – HD76C/HD76

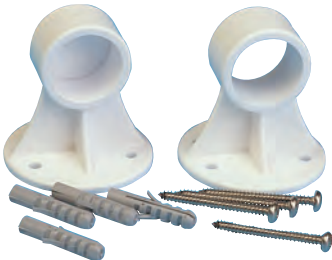

ABS Brackets & Fixings (DOMESTIC ONLY)  
(fixings sold separately – PHR520  
\*\*8mm drill bit required)

Dimensions for ABS Handrail Bracket

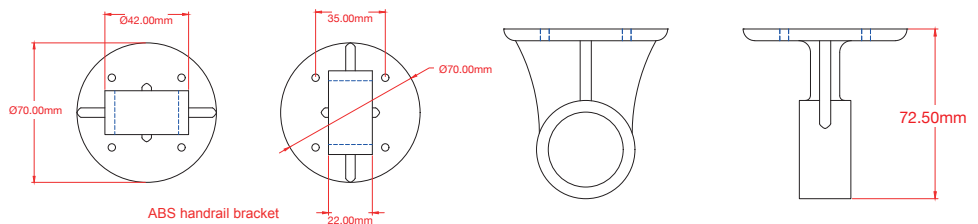

(\*16mm drill bit required, \*\*8mm drill bit required)

## Top Fixing Handrail

DISCOUNT CODE/ PRODUCT CODE	DESCRIPTION	PRICE EACH
J PHR303	1.25" (32mm) Top Fixing Grade 316	£50.65
B PHR521	Bag of 2 Screws & Plugs for PHR303	£2.45

## Handrail Connector & Fixings

DISCOUNT CODE/ PRODUCT CODE	DESCRIPTION	PRICE EACH
J PHR200	1.25" (32mm) Black Handrail Connector	£8.50
K PCR00020	Stainless M8 Bolt & Fixing for PHR301/302*	£8.60
B PHR520	Bag of 4 Screws & Plugs for HD76/HD76C**	£4.15

## ABS Handrail Brackets

DISCOUNT CODE/ PRODUCT CODE	DESCRIPTION	PRICE EACH
B HD76	Open - 1.25"	£6.31
B HD76C	Closed - 1.25"	£6.31

## Stainless Steel Handrail Brackets

DISCOUNT CODE/ PRODUCT CODE	DESCRIPTION	PRICE EACH
J PHR301	Open - 1.25" Grade 316	£63.10
J PHR302	Closed - 1.25" Grade 316	£70.85

## 3m Stainless Steel Handrail

DISCOUNT CODE/ PRODUCT CODE	DESCRIPTION	PRICE EACH
J PHR100	1.25" (32mm) Grade 304	£71.70
J PHR106	1.25" (32mm) Grade 316	£126.50

**Note:** Bespoke Handrail and Balustrading available as a special order, please contact Customer Services for a quotation.

POOL  
SURROUND

## Bespoke Stainless Steel



- Custom stainless steel ladders and handrails to suit your site requirements.
- Available in 304 grade as standard and 316 stainless steel for salt water pools.
- Suitable for both domestic and commercial installation
- Cross bracing available for extra strength
- Manufactured in-house

- Bespoke Ladders
- Custom Handrails
- Grab Rails
- Safety Rails
- Support Rails
- Extra Reach Grab Rails

Contact Customer Services with your requirements for a free quotation 01424 857802

## Lifesaving Equipment

### Lifebelt

DISCOUNT CODE/ PRODUCT CODE	DESCRIPTION	PRICE EACH
K PFR200	🔴 Heavy duty - 440mm Internal Diameter	£85.00

### Life Hook

DISCOUNT CODE/ PRODUCT CODE	DESCRIPTION	PRICE EACH
J PFR400	🔴 Life Hook	£27.00

### Life Hook Poles

DISCOUNT CODE/ PRODUCT CODE	DESCRIPTION	PRICE EACH
D PFR408	🔴 2.4m	£50.20
D PFR412	🔴 3.6m	£67.25
J PRP001	🔴 1.5m Reach Pole	£32.15

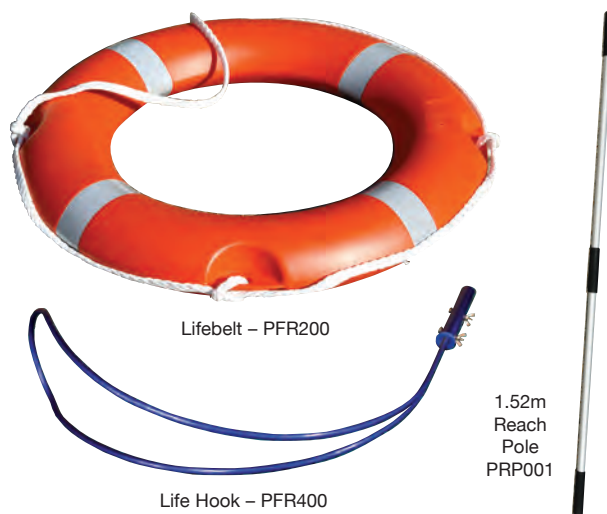

## Fixings

### M10 Stainless Steel Fixings

DISCOUNT CODE/ PRODUCT CODE	DESCRIPTION	PRICE EACH
J ANC001	40mm Internal Threaded Fixing (A)	£11.85
J ANC002	110mm Internal Threaded Resin Fixing (B)	£43.00
J EYEB010	Fixed Eyebolt (C) 100m thread	£17.00

**Note:** ANC001 uses a 12mm drill bit – ANC002 uses an 18mm drill bit.

### Claw Hook

DISCOUNT CODE/ PRODUCT CODE	DESCRIPTION	PRICE EACH
J HOOK005	Claw Hook (D)	£93.70

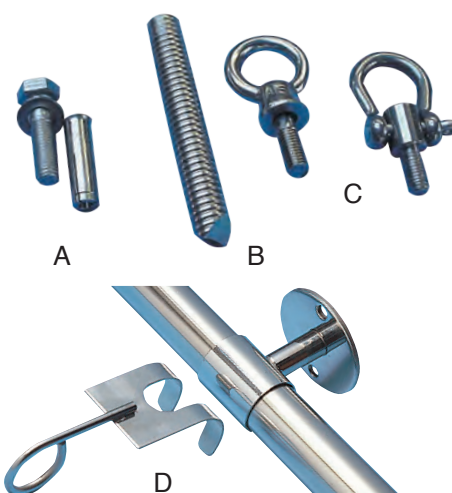

# Airdome

MADE TO ORDER  
HEAVY ITEM



### Cable Type Airdome:

- Maximum size 10m x 23m
- Quick release fittings allow quick removal
- Good foundations are required to secure fixings

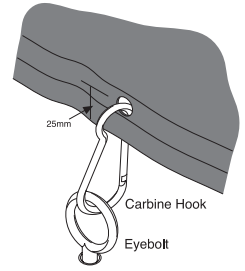

### Waterbag Airdome:

- Maximum size of 8m x 13m
- Sheltered site with a flat surface advisable
- Water bags fixing method allows for quick removal

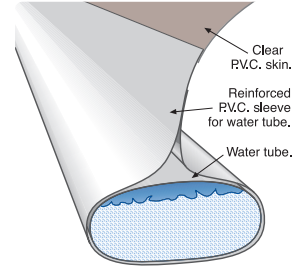

- Two models available for domestic swimming pools:
  - Cable type
  - Waterbag system (suitable for sheltered pool sites up to a maximum size of 8m x 13m (104 sq.m.))
- Supplied with weatherproof fan unit
- All fixings supplied
- Two zipper type doors (standard and 'L' shaped)
- Air pressure relief valve
- Re-inforced and UV stabilised PVC materials
- Clear reinforced
- Planning permission may be required

### Notes:

Zipper doors should be at least 1.5m from dome corners.  
It is advisable to totally deflate the Airdome if high winds or gusts are forecast.  
The pool surround should be level to avoid airloss.  
All prices on application.

POOL SURROUND

# Solar Shower

- Single cold water connection to garden hose
- Water heated by solar power in the integral collector tanks
- 20 litre capacity
- Mixer tap for hot/cold temperature control

## Solar Shower

DISCOUNT CODE/ PRODUCT CODE	DESCRIPTION	PRICE EACH
K SS0911	☀️ 20 litre	£172.00



## Pool & Pond Rollaway Fence



POOL SURROUND

- Aluminium uprights
- Strong plastic coated polyester mesh
- Easily stored in rolls when not in use
- 1m long sections, 1.2m high
- Slots into ground fixings and joins together with connectors
- Complete with ground sleeves and caps for concrete installation
- 1 connector hook supplied with each section
- Fixings also available for paving or grass
- Plugs supplied to cover open holes when fence is removed
- Dark green

**Notes:** For grass fixing you will need one ground stake per post.  
The two rigid panels are designed to go between the Self Closing Gate and any corner or curved section of the fencing.  
The gate (GAT010) does not include fixings.

### Rollaway Fence with Concrete Fixings

DISCOUNT CODE/ PRODUCT CODE	DESCRIPTION	PRICE EACH
K PRF601	1m with 2 Posts	£52.00
K PRF602	2m with 3 Posts	£78.00
K PRF603	3m with 4 Posts	£116.00
K PRF604	4m with 5 Posts	£155.00
K PRF605	5m with 6 Posts	£194.00
K GAT010	Surface Mount Self Closing Gate	£611.00
K PRF601H	0.5m Rigid Panel	£116.00
K PRF601Q	0.25m Rigid Panel	£102.00
K PCR00020	Stainless Steel M8 Bolt & Fixing*	£8.60



This product fully conforms to AFNOR safety standard NF P 90-306.

The gate will require 8 bolts to secure it down. We can supply these complete with a nylon deck fixing as PCR0020. This is assuming that the gate is to be fixed into secure paving or a cement base.

## Pool & Pond Rollaway Fence



Connector Hook – CHK001

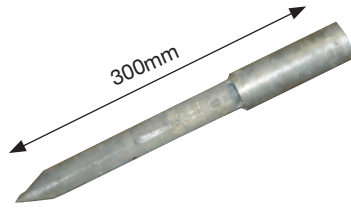

Ground Stake – STA001



Ground Stake Driver – DRI001

### Accessories

DISCOUNT CODE/ PRODUCT CODE	DESCRIPTION	PRICE EACH
K STA001	Ground Stake (Galvanised Steel)	£28.00
K DRI001	Ground Stake Driver (Galvanised)	£4.00
K GLU200	Epoxy Glue For Sleeves	£28.00
K SLE200	Sleeve for Concrete Installation	£3.50
K CAP200	Post Cap	£2.50
K CAP201	Sleeve Cap	£2.50
K CHK001	Connector Hook	£8.00
K KEY001	Gate Key Pre 2014	£15.00
K KEY006	Gate Key Post 2014	£15.00



Concrete Sleeve – SLE200



Epoxy Glue – GLU200



Sleeve Cap – CAP201



Post Cap – CAP200

## Immerstar Pool Alarm

- Fastens to pool edge
- Pressure sensor system
- Not set off by wind
- LED status indicators
- Operates with a magnet contact key
- 100db integrated siren
- Weighs 2.8kg
- Automatically switches from swim to alert mode
- Manufactured in Europe
- Detection in the swimming pool is optimum within a radius of 7m around the sensor. Beyond this range, the swimming pool should be equipped with one or more additional immersion detectors

### Immerstar Pool Alarm

DISCOUNT CODE/ PRODUCT CODE	DESCRIPTION	PRICE EACH
K IMM100	Alarm	£425.00
K IMM001	Winter Extension Pipe Accessory	£29.00



# Covers & Reels

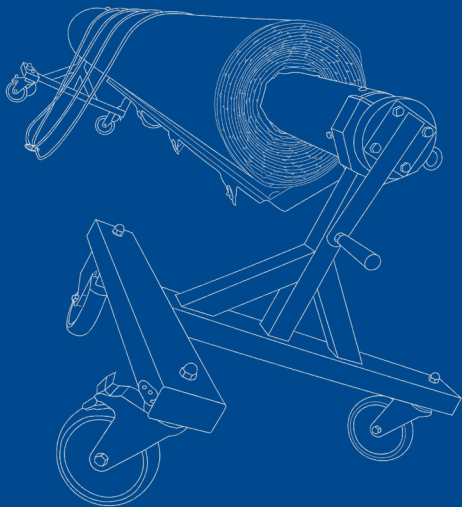

COVERS  
& REELS



# Solar Cover

BULKY



Points common to all Solar Covers:

- Covers are invoiced to the nearest square metre
- When calculating cover prices, round up to the nearest square metre
- Covers come complete with a Solar Protector Sheet to be used when the cover is off the pool
- Covers are made oversized
- Non-hemmed covers are rectangular to be trimmed on site
- Add shaping charge for non hemmed covers if exact size required
- Covers over 12m should be fitted with reinforcing and a leading edge
- All covers fitted with a Commercial Leading Edge will be rolled and could therefore incur a Commercial Carriage Charge. All other Solar Covers are bagged

**Note:** To convert from square feet to square metres multiply the square foot size by 0.0929.

## Finishing Options

DISCOUNT CODE/ PRODUCT CODE	DESCRIPTION	PRICE EACH
J HEM400S	Hemming for Solar Covers per m. run	£5.05
J SHPMCOMS	Shaping Surcharge per m <sup>2</sup>	£4.40
J CUTCOMS	Cut-out Charge for Floating Covers	£58.00
J SHPACOMS	Charge for Shaping Bay	£47.70
K FITSTRAPS	Attach Strap Set to Cover (per strap)	£16.00
K WEB025	25m Roll of Blue Webbing (25mm)	£29.00
K EYELETS	Reinforced Eyelet	£6.00

**Note:** Welding on solar covers can lead to a slight waving.

Cover guarantee is void if pool temperature exceeds 29°C or SPATA standards for chemical and TDS levels are not met.

Hemming is available in blue, black or grey.  
If hemming is ordered it will be blue as standard on the Solar Cover.

# Premium Domestic Leading Edge

BULKY



- Strong and durable PVC coated polyester netting
- Polyethylene foam inserts for added buoyancy
- Easily installed on new or existing covers by end user
- Complete with fixings and pull cord including our new slide lock clip
- Now also available in black

## Premium Domestic Leading Edge

DISCOUNT CODE/ PRODUCT CODE	DESCRIPTION	PRICE EACH
R4 CLE012BLC	12' Blue *	£145.00
R4 CLE016BLC	16' Blue **	£177.00
R4 CLE020BLC	20' Blue ***	£210.00
R4 DLE12S	Attach 12' * Blue	£202.00
R4 DLE16S	Attach 16' ** Blue	£240.00
R4 DLE20S	Attach 20' *** Blue	£276.00
R4 CLE012BKC	12' Black (3.65m model)	£145.00
R4 CLE016BKC	16' Black (4.8m model)	£177.00
R4 CLE020BKC	20' Black (6.10m model)	£210.00
R4 DLE12SBK	Attach Black	£202.00
R4 DLE16SBK	Attach Black	£240.00
R4 DLE20SBK	Attach Black	£276.00

\* for pool sizes up to 3.96m wide (9.14m tow cord)

\*\* for pool sizes 3.97m to 5.18m wide (12.19m tow cord)

\*\*\* for pool sizes 5.19m to 6.4m wide (15.24m tow cord)



**Note:** Covers 10m<sup>2</sup> and over will be charged at Bulky rate and are excluded from free delivery.

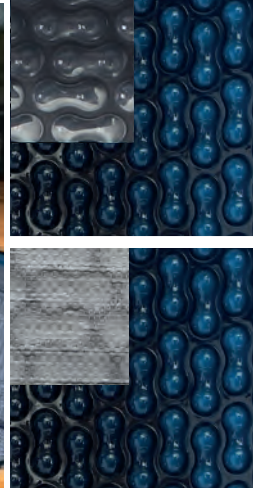

- 500 micron
- Eliminate water evaporation by 98%+
- Reduce chemical consumption by up to 60%
- Lower energy consumption by over 60%
- 6 year pro-rata warranty (UK & Eire only)
- Reduce debris contamination
- Increases water temperature by up to 5°C in the UK
- Reduces filtration time by up to 50%
- Can be used as a winter cover
- Reduces debris contamination
- EnergyGuard 180 has higher UV stabilisation which is designed for use in hotter climates
- Now available in a woven top sheet for extra strength



### Award Winning Material

EnergyGuard Selective Transmission has been awarded the 2018 Business Innovation Award for delivering significant societal and economic impact through the application of physics.



### Selective Transmission

The bubble layer of the material uses a patented midnight blue pigment combination which gives the material its selective transmission properties. The pigment formulation works as a selective filter absorbing the visible wavelengths responsible for photosynthesis. This absorbed energy is passed to the pool through conduction, while the transmission properties of the bubble layer allows for Infrared Radiation (IR) wavelengths to pass through the material and be directly absorbed by the water.



### Debris and Algae Control

As well as preventing debris from entering the pool, EnergyGuard Selective Transmission helps maintain a pleasant, warm swimming environment by using light filtration technology to absorb the wavelengths that promote the growth of algae, reducing the cost and time spent on maintenance.



### Heat Retention

The unique profile of the GeoBubble technology air cells provide both buoyancy and an insulative air gap to control heat transfer enabling the material to manage the pool environment and keep the pool and the desired temperature.



### Evaporation Control

Our materials reduce water losses through evaporation by working as a barrier between the water's surface and the atmosphere. By simply covering the pool with the material, evaporation is reduced by over 98%, resulting in the preservation of the water resources and increased temperature within the swimming pool.

EnergyGuard™ is a registered trademark and patented.

## EnergyGuard™ Selective Transmission Cover

DISCOUNT CODE/ PRODUCT CODE	DESCRIPTION	PRICE EACH
R PGE500B	EnergyGuard™ per m <sup>2</sup> 140 UV Protection	£16.96
R PGE580B	EnergyGuard™ per m <sup>2</sup> 180 UV Protection	£17.80
R PGE510B	10' x 20' (19m <sup>2</sup> ) 140 Grade	£322.31
R PGE512B	12' x 24' (27m <sup>2</sup> ) 140 Grade	£458.01
R PGE514B	14' x 28' (36m <sup>2</sup> ) 140 Grade	£593.72
R PGE515B	15' x 30' (42m <sup>2</sup> ) 140 Grade	£712.47
R PGE516B	16' x 32' (48m <sup>2</sup> ) 140 Grade	£814.25
R PGE520B	20' x 40' (74m <sup>2</sup> ) (6m x 12m) 140 Grade	£1,255.30
R PGE550B	5' x 10' Bay (5m <sup>2</sup> ) 140 Grade	£84.82
J PGEW600	▲ EnergyGuard® per m <sup>2</sup> Weave	£20.74

## Finishing Options

Please refer to page 114 for all finishing options.

**Notes:** Welding on solar covers can lead to a slight waving.

Cover guarantee is void if pool temperature exceeds 29°C or SPATA standards for chemical and TDS levels are not met.

Covers 10m<sup>2</sup> and over will be charged at Bulky rate and are excluded from free delivery.

Hemming is available in blue, black or grey. If hemming is ordered it will be black as standard on the EnergyGuard Selective Transmission Cover.

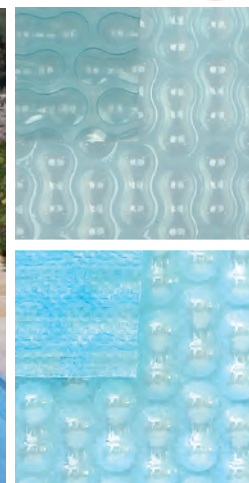

- 500 micron
- Eliminate water evaporation by 98%+
- Reduce chemical consumption by up to 40%
- Lower energy consumption by over 70%
- 6 year pro-rata warranty (UK & Eire only)
- Increases water temperature by up to 6°C in the UK
- Sol+Guard 180 has higher UV stabilisation which is designed for use in hotter climates
- Reduce debris contamination
- Now available in a woven top sheet for extra strength



**COVERS & REELS**

## Sol+Guard 500™ Cover

DISCOUNT CODE/ PRODUCT CODE	DESCRIPTION	PRICE EACH
R PGS500	Sol+Guard 500™ per m <sup>2</sup> 140 UV Protection	£16.96
R PGS580	Sol+Guard 500™ per m <sup>2</sup> 180 UV Protection	£17.80
R PGS510B	10' x 20' (19m <sup>2</sup> ) 140 Grade	£322.31
R PGS512B	12' x 24' (27m <sup>2</sup> ) 140 Grade	£458.01
R PGS514B	14' x 28' (35m <sup>2</sup> ) 140 Grade	£593.72
R PGS515B	15' x 30' (42m <sup>2</sup> ) 140 Grade	£712.47
R PGS516B	16' x 32' (48m <sup>2</sup> ) 140 Grade	£814.25
R PGS520B	20' x 40' (74m <sup>2</sup> ) 140 Grade	£1,255.30
R PGS550B	5' x 10' Bay (5m <sup>2</sup> ) 140 Grade	£84.82
J PGSW700	▲ Sol+Guard 500™ per m <sup>2</sup> Weave	£20.74

## Finishing Options

Please refer to page 114 for all finishing options.

**Notes:** Welding on solar covers can lead to a slight waving.

Cover guarantee is void if pool temperature exceeds 29°C or SPATA standards for chemical and TDS levels are not met.

Covers 10m<sup>2</sup> and over will be charged at Bulky rate and are excluded from free delivery.

Hemming is available in blue, black or grey. If hemming is ordered it will be blue as standard on the Sol+Guard 500 cover.



### Solar Gains

The Sol+Guard 500 micron transparent swimming pool cover material transmits 80% of the sun's energy in the visual and IR spectrum through the material to heat the water in the swimming pool. Sol+Guard has been seen to increase pool temperatures by up to 8°C above the ambient pool temperature, reducing the heating demand by up to 70%.



### Heat Retention

The unique profile of the GeoBubble technology air cells provide both buoyancy and an insulative air gap to control heat transfer enabling the material to manage the pool environment and keep the pool and the desired temperature.



### Evaporation Control

Our materials reduce water losses through evaporation by working as a barrier between the water's surface and the atmosphere. By simply covering the pool with the material, evaporation is reduced by over 98%, resulting in the preservation of the water resources and increased temperature within the swimming pool.



### Debris Control

Covering your pool prevents dirt, leaves, insects and other debris from entering the pool, maintaining a clean, pleasant swimming environment and reducing chemical demand.

Sol+Guard™ is a registered trademark of Plastipack Limited.



- Gold underside gives an aqua blue top colour
- 500 micron
- 0.48Kg per m<sup>2</sup>
- Blue top with gold underside
- 4 year pro-rata warranty (UK & Eire only)
- 3 day lead time
- Increases water temperature by up to 2-3°C in the UK



### Evaporation Control

Our materials reduce water losses through evaporation by working as a barrier between the water's surface and the atmosphere. By simply covering the pool with the material, evaporation is reduced by over 98% resulting in the preservation of the water resources and increased temperatures within the swimming pool, saving water and preventing evaporative cooling.



### Heat Retention

The unique profile of the GeoBubble technology air cells provide both buoyancy and an insulative air gap to control heat transfer enabling the material to manage the pool environment and keep the pool and the desired temperature.



### Temperature Increase

GeoBubble covers help to increase pool temperature by allowing for solar gains, as well as retaining the gained heat by providing a barrier to evaporation and an insulative air gap.



### Debris Control

Covering your pool prevents dirt, leaves, insects and other debris from entering the pool, maintaining a clean, pleasant swimming environment and reducing chemical demand.

## Midas 500 Cover

DISCOUNT CODE/ PRODUCT CODE	DESCRIPTION	PRICE EACH
R PGM500	Midas 500 per m <sup>2</sup>	£15.54
R PGM510	10' x 20' (19m <sup>2</sup> )	£295.35
R PGM512	12' x 24' (27m <sup>2</sup> )	£419.70
R PGM514	14' x 28' (36m <sup>2</sup> )	£559.60
R PGM515	15' x 30' (42m <sup>2</sup> )	£652.87
R PGM516	16' x 32' (48m <sup>2</sup> )	£746.14
R PGM520	20' x 40' (74m <sup>2</sup> ) (6m x 12m)	£1,150.29
R PGM550	5' x 10' (5m <sup>2</sup> )	£77.72

## Finishing Options

Please refer to page 114 for all finishing options.

**Notes:** Welding on solar covers can lead to a slight waving.

Cover guarantee is void if pool temperature exceeds 29°C or SPATA standards for chemical and TDS levels are not met.

Covers 10m<sup>2</sup> and over will be charged at Bulky rate and are excluded from free delivery.

Hemming is available in blue, black or grey. If hemming is ordered it will be blue as standard on the Midas 500 cover.

**COVERS & REELS**

**FOR SUGGESTED PLANT & HEATING GUIDE FOR IN-GROUND POOLS, SEE OUR CHART ON PAGE 261**



- Silver underside gives extra heat retention
- 400 micron
- 0.37kg per m<sup>2</sup>
- Blue top with silver underside
- 4 year pro-rata warranty (UK & Eire only)
- 3 day lead time
- Increases water temperature by up to 2-3°C in the UK



### Evaporation Control

Our materials reduce water losses through evaporation by working as a barrier between the water's surface and the atmosphere. By simply covering the pool with the material, evaporation is reduced by over 98% resulting in the preservation of the water resources and increased temperatures within the swimming pool, saving water and preventing evaporative cooling.



### Heat Retention

The unique profile of the GeoBubble technology air cells provide both buoyancy and an insulative air gap to control heat transfer enabling the material to manage the pool environment and keep the pool and the desired temperature.



### Temperature Increase

GeoBubble covers help to increase pool temperature by allowing for solar gains, as well as retaining the gained heat by providing a barrier to evaporation and an insulative air gap.



### Debris Control

Covering your pool prevents dirt, leaves, insects and other debris from entering the pool, maintaining a clean, pleasant swimming environment and reducing chemical demand.

Hemming is available in blue, black or grey. If hemming is ordered it will be blue as standard on the Apollo 400 cover.

COVERS & REELS

## Apollo 400 Cover

DISCOUNT CODE/ PRODUCT CODE	DESCRIPTION	PRICE EACH
R PGA400	Apollo 400 per m <sup>2</sup>	£12.00
R PGA410	10' x 20' (19m <sup>2</sup> )	£227.94
R PGA412	12' x 24' (27m <sup>2</sup> )	£323.92
R PGA414	14' x 28' (36m <sup>2</sup> )	£431.89
R PGA415	15' x 30' (42m <sup>2</sup> )	£503.87
R PGA416	16' x 32' (48m <sup>2</sup> )	£575.86
R PGA420	20' x 40' (74m <sup>2</sup> ) (6m x 12m)	£887.78
R PGA450	5' x 10' Bay (5m <sup>2</sup> )	£59.99

## Finishing Options

Please refer to page 114 for all finishing options.

**Notes:** Welding on solar covers can lead to a slight waving.

Cover guarantee is void if pool temperature exceeds 29°C or SPATA standards for chemical and TDS levels are not met.

Covers 10m<sup>2</sup> and over will be charged at Bulky rate and are excluded from free delivery.



# Blue 400 Cover

BULKY

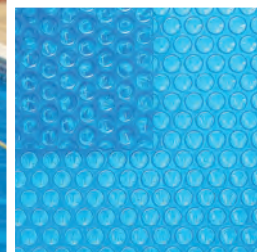

Blue 400 is our most economical option cover that will provide substantial benefits and savings by helping with Evaporation Control, Debris Control and Heat Insulation.

- UV stabilised
- 400 micron
- 0.37kg per m<sup>2</sup>
- Blue top and underside
- 3 year pro-rata warranty (UK & Eire only)
- 3 day lead time
- Increases water temperature by up to 2-3°C in the UK

- Eliminates water evaporation by 98%+
- Reduce debris contamination
- Increase pool temperature
- Reduce chemical consumption
- Reduce energy consumption
- Save money and shrink your carbon footprint



## Blue 400 Cover

DISCOUNT CODE/ PRODUCT CODE	DESCRIPTION	PRICE EACH
R PSC400	Blue 400 per m <sup>2</sup>	£10.77
R PSC410	10' x 20' (19m <sup>2</sup> )	£204.66
R PSC412	12' x 24' (27m <sup>2</sup> )	£290.83
R PSC414	14' x 28' (36m <sup>2</sup> )	£387.77
R PSC415	15' x 30' (42m <sup>2</sup> )	£452.40
R PSC416	16' x 32' (48m <sup>2</sup> )	£517.03
R PSC420	20' x 40' (74m <sup>2</sup> ) (6m x 12m)	£797.09
R PSC450	5' x 10' Bay (5m <sup>2</sup> )	£53.86

## Finishing Options

Please refer to page 114 for all finishing options.

**Notes:** Welding on solar covers can lead to a slight waving.

Cover guarantee is void if pool temperature exceeds 29°C or SPATA standards for chemical and TDS levels are not met.

Covers 10m<sup>2</sup> and over will be charged at Bulky rate and are excluded from free delivery.

Hemming is available in blue, black or grey. If hemming is ordered it will be blue as standard on the Blue 400 cover.

COVERS  
& REELS



- 500 micron
- Eliminate water evaporation by 98%
- Reduce chemical consumption by up to 50%
- Lower energy consumption by over 50%
- 6 year+ pro-rata warranty (UK & Eire only)
- Minimise daily solar gains by 55%
- Reduce debris contamination
- Maintain a 10% cooler pool
- Save money and reduce carbon footprint of your pool



### Heat Reflection

CoolGuard Ultra's increased reflectivity provides a dramatic improvement to the regulation of the pool's temperature. Its Glacial Blue colour brings a 25% improvement in reflectivity across the visible and IR spectrum, providing a barrier to reduce solar gains, ensuring a cooler, more refreshing swimming temperature.



### Heat Insulation

The unique profile of the GeoBubble technology air cells provide both buoyancy and an insulative air gap to control heat transfer enabling the material to manage the pool environment and keep the pool and the desired temperature.



### Evaporation Control

Our materials reduce water losses through evaporation by working as a barrier between the water's surface and the atmosphere. By simply covering the pool with the material, evaporation is reduced by over 98%, resulting in the preservation of the water resources and increased temperature within the swimming pool.



### Debris Control

Covering your pool prevents dirt, leaves, insects and other debris from entering the pool, maintaining a clean, pleasant swimming environment and reducing chemical demand.

CoolGuard™ is a registered trademark of Plastipack Limited.

## CoolGuard™ Ultra 500 Cover

DISCOUNT CODE/ PRODUCT CODE	DESCRIPTION	PRICE EACH
R PGC500U	CoolGuard™ 80 per m <sup>2</sup>	£17.80

## Finishing Options

Please refer to page 114 for all finishing options.

**Notes:** Welding on solar covers can lead to a slight waving.

Cover guarantee is void if pool temperature exceeds 29°C or SPATA standards for chemical and TDS levels are not met.

Covers 10m<sup>2</sup> and over will be charged at Bulky rate and are excluded from free delivery.

Hemming is available in blue, black or grey. If hemming is ordered it will be blue as standard on the CoolGuard cover.

## Black 400 GeoBubble™ Cover

BULKY

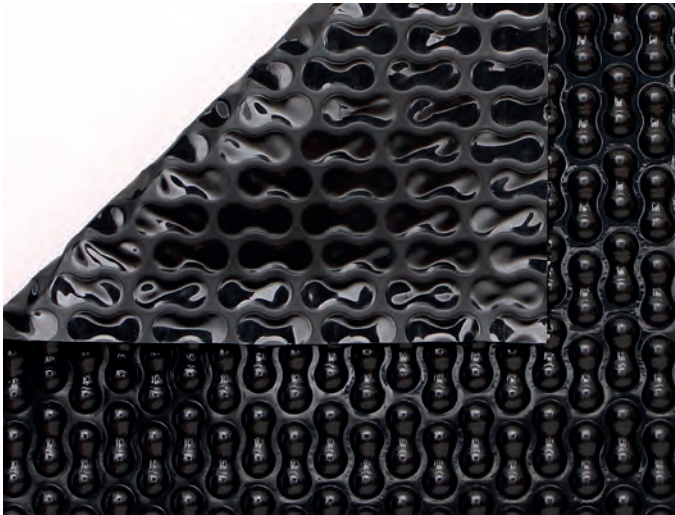

- UV stabilised
- 0.37kg per m<sup>2</sup>
- Black top and underside increases heat conduction
- 100% opaque material helps control the growth of algae
- 3 year pro-rata warranty (UK & Eire only)
- With Geobubble™ Technology

### Black 400 GeoBubble™ Cover

DISCOUNT CODE/ PRODUCT CODE	DESCRIPTION	PRICE EACH
R PSC400GBK	Black 400 Geobubble™ per m <sup>2</sup>	£11.93

Hemming is available in blue, black or grey. If hemming is ordered it will be black as standard on the Black 400 Geobubble cover.

## Polyweave Heat Retention GeoBubble™ Cover

BULKY

MADE TO ORDER



- UV Stabilised bubble material co-extruded onto woven top sheet
- Tear resistant polyolefine top sheet
- For domestic or small commercial pools
- 400 micron
- 0.52kg per m<sup>2</sup>
- Material width 2.06m
- Despatched in roll form to avoid packing creases
- 3 year pro-rata warranty (UK & Eire only)
- To be shaped on site
- 29°C maximum temperature

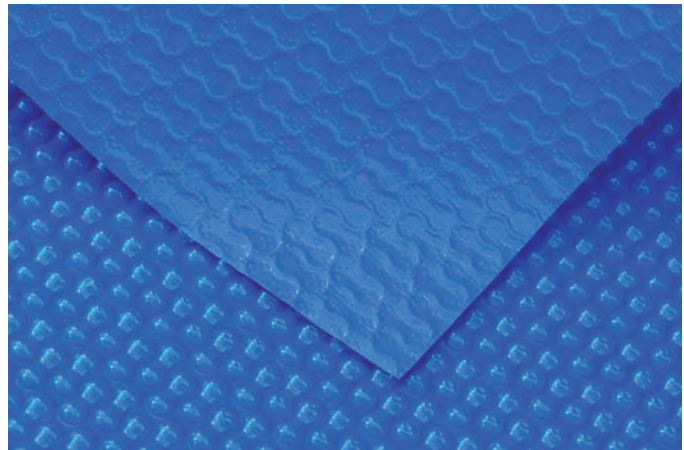

COVERS & REELS

▲ Extra carriage applies to Polyweave Covers.

### Polyweave GeoBubble™ Cover

DISCOUNT CODE/ PRODUCT CODE	DESCRIPTION	PRICE EACH
J PWG100	▲ Polyweave Geobubble™ per m <sup>2</sup>	£20.74

Hemming is available in blue, black or grey. If hemming is ordered it will be blue as standard on the Polyweave cover.

### Finishing Options

Please refer to page 114 for all finishing options.

- Notes:** Welding on solar covers can lead to a slight waving.  
Cover guarantee is void if pool temperature exceeds 29°C or SPATA standards for chemical and TDS levels are not met.  
Covers 10m<sup>2</sup> and over will be charged at Bulky rate and are excluded from free delivery.

TO CONVERT YOUR POOL COVER SIZES IN FEET TO AN AREA IN SQUARE METRES, SEE OUR CHART ON PAGE 262

BULKY



## Above Ground Pool Solar Covers

- Budget solar cover for above ground pools
- Reduce heating costs and chemical usage
- 200 micron
- 0.22kg per m<sup>2</sup>
- 1 year pro-rata warranty (UK & Eire only)



**Note:** These covers require trimming on site.

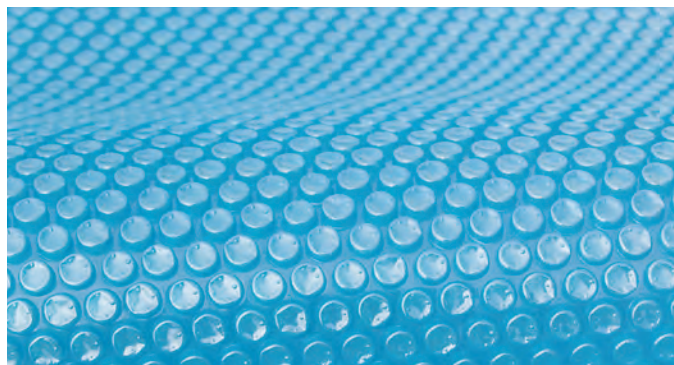

### Oval

DISCOUNT CODE/ PRODUCT CODE	DESCRIPTION	PRICE EACH
L6 ASC112	10' x 15'	£95.88
L6 ASC113	10' x 16'	£102.54
L6 ASC114	12' x 18'	£119.36
L6 ASC117	12' x 20'	£120.95
L6 ASC122	12' x 22'	£122.96
L6 ASC124	12' x 24'	£131.28
L6 ASC126	12' x 28'	£145.26
L6 ASC132	16' x 28'	£179.18
L6 ASC118	15' x 30'	£173.17
L6 ASC134	16' x 32'	£193.05
L6 ASC136	18' x 33'	£214.41

### Diameter

DISCOUNT CODE/ PRODUCT CODE	DESCRIPTION	PRICE EACH
L6 ASC008	8'	£25.31
L6 ASC010	10'	£39.47
L6 ASC012	12'	£52.39
L6 ASC015	15'	£75.70
L6 ASC016	16'	£88.56
L6 ASC018	18'	£132.16
L6 ASC024	24'	£205.32

## Premium Wooden Pool Solar Covers

BULKY



- Budget solar cover for wooden pools
- Reduce heating costs and chemical usage
- 200 micron
- 0.22g per m<sup>2</sup>
- 1 year pro-rata warranty (UK & Eire only)



**Note:** These covers require trimming on site.



### Nazca Pools

DISCOUNT CODE/ PRODUCT CODE	DESCRIPTION	PRICE EACH
L6 WPC242	Cover for Nazca 4m x 2m	£49.21
L6 WPC282	Cover for Nazca 8m x 2m	£110.27
L6 WPC284	Cover for Nazca 8m x 4m	£152.46

### Premium Wooden Pool

DISCOUNT CODE/ PRODUCT CODE	DESCRIPTION	PRICE EACH
L6 WPC100	Clever for 4m Knightsbridge	£65.90
L6 WPC200	Cover for 5m Mayfair	£102.42
L6 WPC300	Cover for 6m Kensington	£117.59
L6 WPC400	Cover for 5.5m x 3.6m Belgravia	£99.36
L6 WPC500	Cover for 6.5m x 3.6m Bayswater	£118.41
L6 WPC600	Cover for 8.1m x 4.6m Westminster	£138.06
L6 WPC700	Cover for 4.2m x 3.9m Exercise Pool	£57.29
L6 WPC800	Cover for 5.5m Hampstead Pool	£149.68

**Notes:** Covers 10m<sup>2</sup> and over will be charged at Bulky rate and are excluded from free delivery.

FOR SUGGESTED PLANT FOR ABOVE GROUND WOODEN POOLS, SEE OUR CHART ON PAGE 261

# Commercial Leading Edge & Reinforcing

INSTALL MADE TO ORDER HEAVY ITEM



- Foam filled and reinforced leading edge
- Helps operation of heat retention covers
- Saves wear and tear
- Blue tarpaulin sleeving surrounding a foam inner

- Heat welded and fitted to cover
- Recommended for all covers over 12m long
- Includes all tow ropes and reinforced reel end
- Laid flat during transportation to avoid creasing

## Leading Edge & Reinforcing

DISCOUNT CODE/ PRODUCT CODE	DESCRIPTION	PRICE EACH
J2 PFA100	Foam Filled Leading Edge and Reinforcing per metre	£145.00
J2 PFA150	Foam Filled Leading Edge per metre	£116.50
J2 PFA275	Reel End Reinforcing per metre	£29.70

**Note:** Above prices include fitting to new covers at time of manufacture.

## Cord & Straps

DISCOUNT CODE/ PRODUCT CODE	DESCRIPTION	PRICE EACH
K COR253	25m of Blue Polycord Roll (5mm)	£29.75
K COR251	25m of Heavy Duty Blue Polycord (8mm)	£59.00
K COR255	25m of Heavy Duty Blue Polycord (10mm)	£86.00
K FITSTRAPS	Attach Strap Set to Cover (per strap)	£16.00

## DIY Reinforcing

DISCOUNT CODE/ PRODUCT CODE	DESCRIPTION	PRICE EACH
J2 PFA301	DIY Reinforcing Material & Connectors per metre	£38.00

**Note:** To strengthen reel end of cover where the straps connect.

## Fixings

DISCOUNT CODE/ PRODUCT CODE	DESCRIPTION	PRICE EACH
J TAR310	Tarpaulin Strap (per linear meter)	£18.35
K WEB025	25m Roll of Blue Webbing (25mm)	£29.00
K SHAK001	6mm D Shackle	£6.90
K HOOK001	Carbine Hook	£4.00
K DSH001	Stainless Steel D-Shackle	£7.75
K RIN020	Stainless Steel Ring (50mm)	£8.90

# Light Commercial Leading Edge

- Can be attached at time of manufacture
- Lightweight
- Cuts down on transport costs
- Can be despatched separately

- Attached on site
- 1.5m tubes and fittings sent as separate package
- Tough PVC coated netting
- Sleeve is self draining and corrosion resistant



## Pre-Fitted

DISCOUNT CODE/ PRODUCT CODE	DESCRIPTION	PRICE EACH
J2 PFA400	7.5m *	£283.00
J2 PFA500	10.5m **	£387.00

\* for pool sizes up to 8m wide (20m long)

\*\* for pool sizes 8.01m to 11m wide (30m long)

## DIY

DISCOUNT CODE/ PRODUCT CODE	DESCRIPTION	PRIC EACH
J2 PFA401	7.5m	£253.00
J2 PFA501	10.5m	£350.00

COVERS & REELS



## Supercover (5mm) - Blue

INSTALL MADE TO ORDER LONG

- 5mm polyolefine closed cell foam cover
- Tough woven top and bottom sheet for heat retention and strength
- Shaped and hemmed to your specification
- Weighs 0.42kg per m<sup>2</sup>
- 29°C maximum temperature
- 3 year pro rata guarantee
- Hemming charge included in per square metre

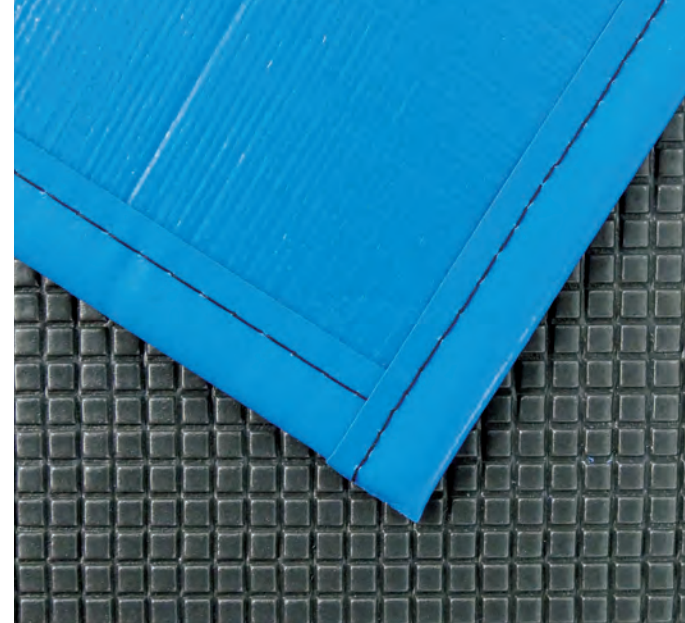

**Note:** Help should be on hand to off-load larger covers upon delivery.

▲ Extra carriage applies to Supercovers.

Supercover (5mm)		
DISCOUNT CODE/ PRODUCT CODE	DESCRIPTION	PRICE EACH
J PSU100	▲ Supercover (5mm) per m <sup>2</sup>	£35.00

### Finishing Options

Please refer to page 114 for all finishing options.

**Notes:** Covers 10m<sup>2</sup> and over will be charged at Bulky rate and are excluded from free delivery.

Hemming is available in blue, black or grey. If hemming is ordered it will be blue as standard on the blue Supercover cover.

COVERS & REELS

## Supercover (5mm) - Grey

INSTALL MADE TO ORDER LONG



- 5mm polyolefine closed cell foam cover
- Tough woven top and bottom sheet for heat retention and strength
- Shaped and hemmed to your specification
- Weighs 0.42kg per m<sup>2</sup>
- 29°C maximum temperature
- 3 year pro rata guarantee
- Hemming charge included in per square metre



**Note:** Help should be on hand to off-load larger covers upon delivery.

▲ Extra carriage applies to Supercovers.

Supercover (5mm)		
DISCOUNT CODE/ PRODUCT CODE	DESCRIPTION	PRICE EACH
J PSU200	▲ Supercover (5mm) per m <sup>2</sup>	£35.00

### Finishing Options

Please refer to page 114 for all finishing options.

**Notes:** Covers 10m<sup>2</sup> and over will be charged at Bulky rate and are excluded from free delivery.

Hemming is available in blue, black or grey. If hemming is ordered it will be grey as standard on the grey Supercover cover.

# Heat Retention Covers

LONG



Over 90% of a pool's heat is lost via the water surface; this can be considerably reduced by using a heat retention cover

- Reduce humidity levels
- Reduce the need for heating and ventilation
- Installs on most pool types including free-form pools
- Covers should recoup their costs from energy saving within twelve months
- Covers over 12m should have reinforcing and a leading edge
- Covers are despatched in roll form
- Packaging adds approximately 150mm to cover width
- Perfect lay flat of this material cannot be guaranteed
- We work to +0.2% and -0.5% accuracy of any dimension

## Heat Retention Cover Pricing Formula

Follow the calculation method to find the Chargeable Area (CA) to the nearest m<sup>2</sup>.

RECTANGULAR	CALCULATION	SHAPED	CALCULATION CIRCULAR
STANDARD SIZE COVER with STEP CUT-OUT	$\text{Cover Price} = \text{Cover Area (CA)} \times \text{Price per m}^2$ PLUS 1 x Cut-Out Charge <b>CUTCOMS</b> per ladder		$\text{CA} = W \times W$ $\text{Cover Price} = \text{CA} \times (\text{Price per m}^2 + \text{Shaping Surcharge per m}^2)$
	<b>RECTANGULAR</b> $\text{CA} = L \times W$ $\text{Cover Price} = \text{CA} \times \text{Price per m}^2$		<b>OVAL</b> $\text{CA} = L \times W$ $\text{Cover Price} = \text{CA} \times (\text{Price per m}^2 + \text{Shaping Surcharge per m}^2)$
	<b>ROMAN END</b> $\text{CA} = L \times W$ List Price = CA x Price per m <sup>2</sup> Add 1 x Charge for Bay Shaping		<b>FREEFORM/KIDNEY</b> $\text{CA} = L \times W$ $\text{Cover Price} = \text{CA} \times (\text{Price per m}^2 + \text{Shaping Surcharge per m}^2)$
	<b>DOUBLE ROMAN END</b> $\text{CA} = L \times W$ List Price = CA x Price per m <sup>2</sup> Add 2 x Standing Charge for Bay Shaping		<b>SHAPED OVAL/PEAR</b> $\text{CA} = L \times W$ $\text{Cover Price} = \text{CA} \times (\text{Price per m}^2 + \text{Shaping Surcharge per m}^2)$
	<b>WALK IN STAIRS/BAYS</b> $\text{CA} = L \times W + (L2 \times W2)$ List Price = CA x Price per m <sup>2</sup> Add 1 x Charge for Bay Shaping		<b>DOG LEG/LAZY 'L'</b> $\text{CA} = L \times W + (L2 \times W2)$ $\text{Cover Price} = \text{CA} \times (\text{Price per m}^2 + \text{Shaping Surcharge per m}^2)$

COVERS & REELS

## Premium (8mm)

INSTALL MADE TO ORDER LONG



- 8mm foam centre with embossed underside
- Polyolefine woven fabric top laminate with UV stabilised coating
- Shaped and hemmed to your specification
- Suitable for hydrotherapy pools
- Weighs 0.53kg per m<sup>2</sup>
- 29°C maximum temperature (39°C max for hydrotherapy pools)
- 4 year pro rata guarantee (one year on hydrotherapy pools)
- Hemming charge included in per square metre

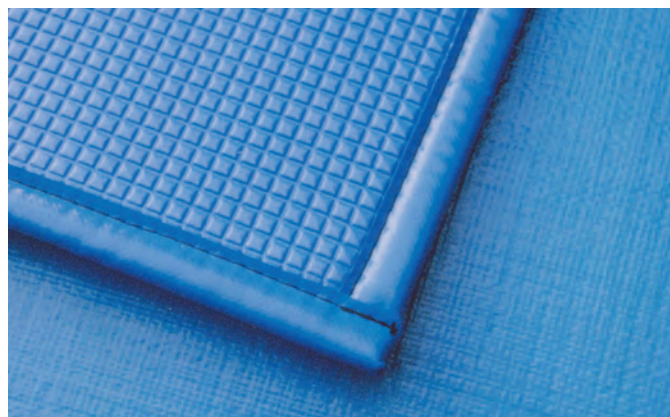

**Note:** Help should be on hand to off-load larger covers upon delivery.

▲ Extra carriage may be applicable to Premium Covers.

Premium (8mm)		
DISCOUNT CODE/ PRODUCT CODE	DESCRIPTION	PRICE EACH
J PPR100	▲ Premium (8mm) per m <sup>2</sup>	£49.50

Hemming is available in blue, black or grey. If hemming is ordered it will be blue as standard on the Premium cover.

## Finishing Options

**Note:** Covers over 3m length when packed will be charged a long length charge per cover and are excluded from free delivery.

Please refer to page 114 for all finishing options.



New for 2022

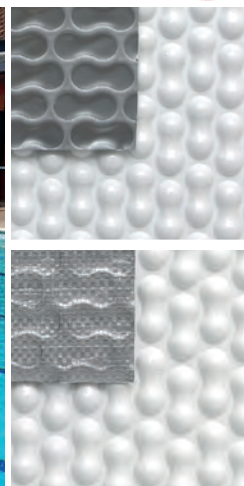

- 500 micron
- Retain heat and maintain pool temperature
- Reduce heating cost by up to 57%
- Pay back the cost of a cover within 1 year
- Works on both indoor and outdoor pools
- Eliminate evaporation by 98%
- Reduce debris contamination
- Save money and reduce the environmental impact of your pool
- 6+ years expected lifespan
- With GeoBubble™ Technology
- Available with reinforcing weave



▲ Extra carriage applies to RaeGuard Weave Covers.

## RaeGuard™ Heat Retention Cover

DISCOUNT CODE/ PRODUCT CODE	DESCRIPTION	PRICE EACH
J RAEG140	▲ RaeGuard™ Cover per m <sup>2</sup> 140 UV Protection	£16.96
J RAES140	▲ RaeGuard™ Cover per m <sup>2</sup> 140 UV Protection Weave	£20.74

## Finishing Options

Please refer to page 114 for all finishing options.

**Notes:** Welding on solar covers can lead to a slight waving.

Cover guarantee is void if pool temperature exceeds 29°C or SPATA standards for chemical and TDS levels are not met.

Covers 10m<sup>2</sup> and over will be charged at Bulky rate and are excluded from free delivery.

Hemming is available in blue, black or grey. If hemming is ordered it will be grey as standard on the RaeGuard cover.



### Reflective

The specially selected pigments of RaeGuard™'s silver & white layers are designed to reflect and scatter radiative heat, and maximise reflection in the targeted mid-infrared region.

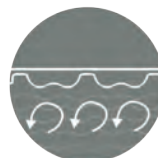

### Heat Retention

The unique GeoBubble™ air cell provides a substantial barrier layer which works to prevent the transfer of thermal energy away from the surface of a pool.



### Evaporation Control

When a pool is covered, instead of using energy to turn into water vapour, your pool water retains its thermal energy and stays warmer.



### Reinforced Weave

Our new woven material range comes with all the benefits of GeoBubble™ with an improved strength, durability and longevity. The new style weave is tighter, with a higher tensile strength, for a longer-lasting, tougher material for your pool.

RaeGuard™ is a registered trademark and patented product of Plastipack Limited.

## Spa Cover (12mm)

MADE TO ORDER

LONG



- For spas and hydrotherapy pools
- 12mm foam centre
- Laminated top and bottom with embossed clear protective layer
- Weighs 0.49kg per m<sup>2</sup>
- 39°C maximum running temperature
- Guarantee limited to 1 year due to higher water temperatures and chemicals.

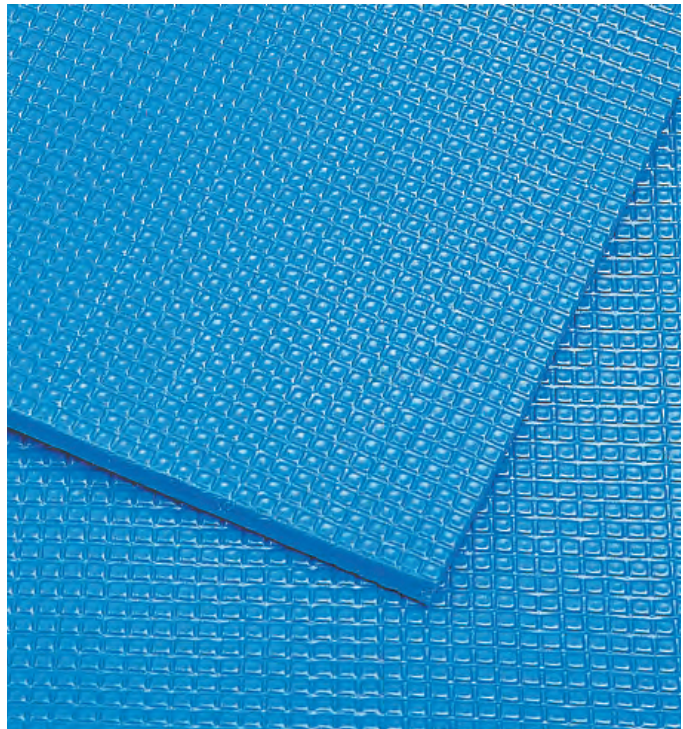

**Note:** Not suitable for use with Reel Systems. Not hemmed. Help should be on hand to off-load larger covers upon delivery.

▲ Extra carriage applies to Spa Covers.

### Spa Cover (12mm)

DISCOUNT CODE/ PRODUCT CODE	DESCRIPTION	PRICE EACH
J PSP200	▲ Spa Cover (12mm) per m <sup>2</sup>	£45.50

### Finishing Options

Please refer to page 114 for all finishing options.

**Notes:** Welding on solar covers can lead to a slight waving.

Cover guarantee is void if pool temperature exceeds 29°C or SPATA standards for chemical and TDS levels are not met.

**Note:** Covers over 3m length when packed will be charged a long length charge per cover and are excluded from free delivery.

# SLIDE, LOCK AND GRIP... WITH A PIRANHA CLIP

New for  
2022

MANUFACTURED  
IN THE UK

*Grips any standard cover*  
**PERMANENTLY**  
Contact your Plastica  
account manager for  
a **FREE** sample

See page 128 for details

COVERS & REELS



# Slidelock Telescopic Reel

- Polished stainless steel end stands
- Anodised aluminium tubes
- Plastic end bosses and steering wheels
- Straps connect to tubes by our unique slide and lock fixing
- Locking device holds the tube in position, stopping the cover from unwinding.
- Range of different end stands
- Optional castor pack
- Small Slidelock tubes go from 3.7m to 4.9m, for covers up to a maximum 4.6m width (12' to 16' tubes - 15' maximum cover width)
- Large Slidelock tubes go from 5.0m to 6.7m, for covers over 4.6m up to a maximum 6.4m width (16'5" to 22' tubes - 21' maximum cover width)

**Notes:** Reels should be set up to have a maximum 300mm overlap each side.

Maximum recommended area of material on both reels is 75m<sup>2</sup>.

Cover/tube overlap should be kept to a minimum.

Some flexing of the tube may occur with larger covers.



**Note:** Castors are sold separately

## Accessories

DISCOUNT CODE/ PRODUCT CODE	DESCRIPTION	PRICE EACH
K PRD113	140CM Elastic Cords with Toggle Ends (pack of 8)	£17.50
K PRD115	Elasticated Quick Fit Strap Kit (pack of 3)	£13.00
G PRD125	Pair of Threaded Deck Anchors	£56.00
G PRD130	Additional Height of 300mm per pair	£45.30
G PRD151	Pack of 6 Plated Castors (43mm tube) contains x4 braked and x2 unbraked.	£148.00
G PRD161	Pack of 6 Stainless Steel Castors (43mm tube) contains x4 braked and x2 unbraked.	£267.00
K PIRA110	Pack of 10 Blue Piranha Clips	£17.50
K PIRA150	Pack of 50 Blue Piranha Clips	£87.50
K PIRA210	Pack of 10 Black Piranha Clips	£17.50
K PIRA250	Pack of 50 Blue Piranha Clips	£87.50

## Accessories

DISCOUNT CODE/ PRODUCT CODE	DESCRIPTION	PRICE EACH
K PRD20040	Pack of 10 Blue Universal Strap Sets (individually packed)	£79.00
K PRD20040BK	Pack of 10 Black Universal Strap Sets (individually packed)	£79.00
K PRD20041	Pack of 10 Blue Universal Strap Sets (not individually packed)	£71.00
K PRD20041BK	Pack of 10 Black Universal Strap Sets (not individually packed)	£71.00
K PRD020PFB	Pack of 20 Blue Press Fix Connectors	£17.20
K PRD020PFBK	Pack of 20 Black Press Fix Connectors	£17.20
K PRD050PFB	Pack of 50 Blue Press Fix Connectors	£43.00
K PRD050PFBK	Pack of 50 Black Press Fix Connectors	£43.00
K PRD100PFB	Pack of 100 Blue Press Fix Connectors	£86.00
K PRD100PFBK	Pack of 100 Black Press Fix Connectors	£86.00
K SLC00110	Pack of 10 Blue Slidelock Clips	£12.00
K SLC00210	Pack of 10 Black Slidelock Clips	£12.00

COVERS & REELS



Piranha Clip - PIRA110/PIRA150



Elastic cords with toggle ends Kit - PRD113

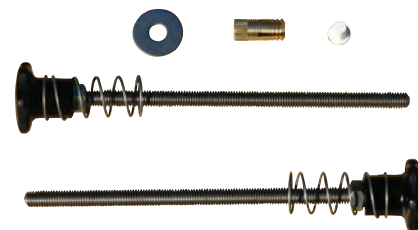

Deck Anchors - PRD125



Strap Kit - PRD115



Slidelock Clip, Blue - SLC00110



Slidelock Clip, Black - SLC00210



Press Fix Connector - PRD020PFB

## Wedges (pack of 10)

DISCOUNT CODE/ PRODUCT CODE	DESCRIPTION	PRICE EACH
K RTS100	Reel Thumb Screws	£17.60
K WED100	Large Inner Wedges	£17.60
K WED200	Small Outer Wedges	£17.60
K RTS100B	Reel Thumb Screws Black	£17.60
K WED100B	Large Inner Wedges Black	£17.60
K WED200B	Small Outer Wedges Black	£17.60

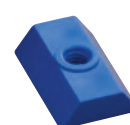
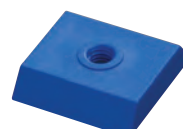

RTS100 - WED100 - WED200



# Slidelock Telescopic Reel

**BULKY**

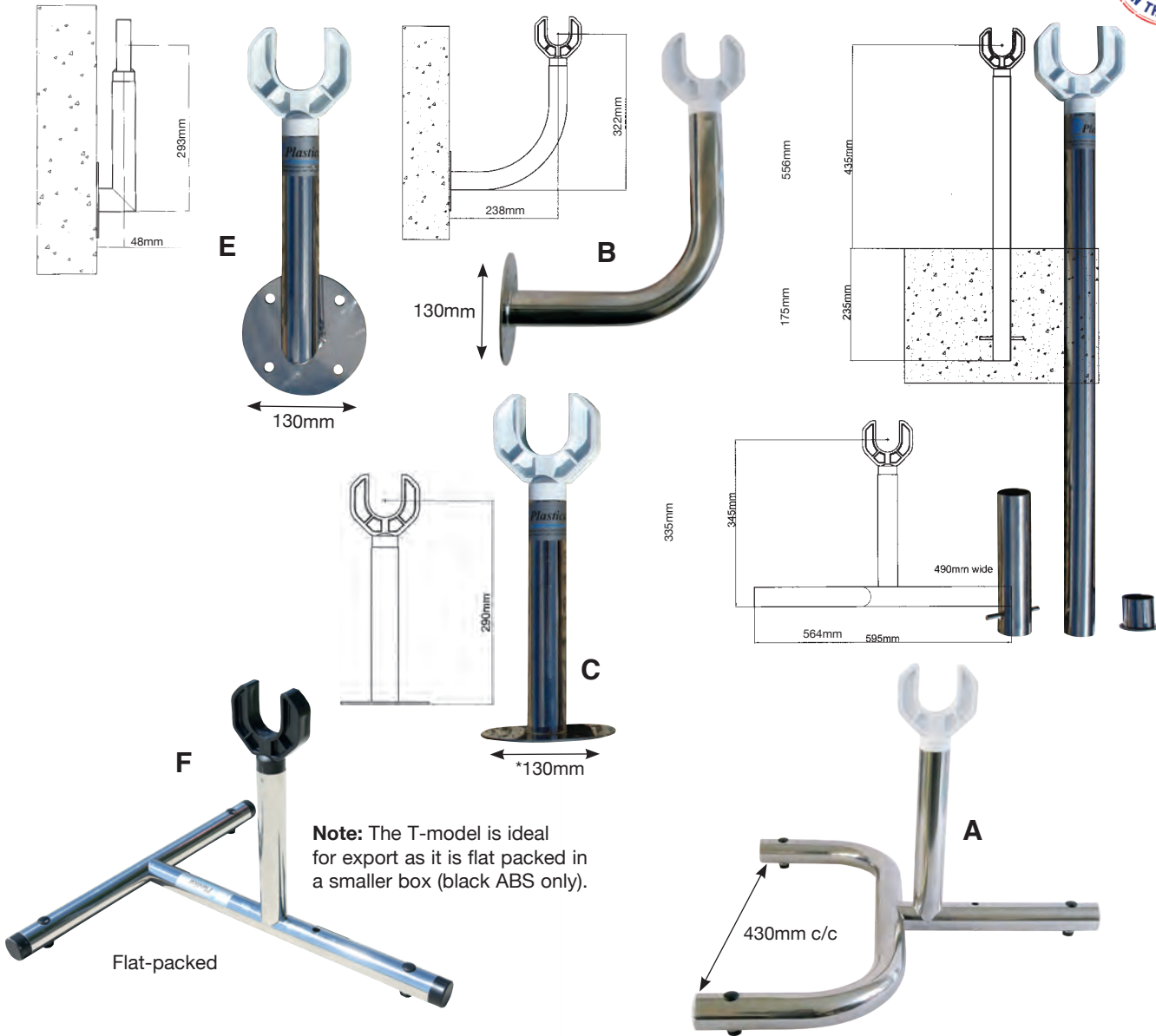

**COVERS & REELS**

43mm Small Slidelock (complete)			43mm Large Slidelock (complete)		
DISCOUNT CODE/ PRODUCT CODE	DESCRIPTION	PRICE EACH	DISCOUNT CODE/ PRODUCT CODE	DESCRIPTION	PRICE EACH
G PRD2043K	43mm Small Standard Slidelock Reel (A)	£867.00	G PRD2543K	43mm Large Standard Slidelock Reel (A)	£949.00
G PRD2143K	43mm Small Wall Mounted Slidelock Reel (B)	£867.00	G PRD2643K	43mm Large Wall Mounted Slidelock Reel (B)	£949.00
G PRD2243K	43mm Small Base Plate Slidelock Reel (C)	£867.00	G PRD2743K	43mm Large Base Plate Slidelock Reel (C)	£949.00
G PRD2343K	43mm Small Sleeve Mounted Slidelock Reel (D)	£867.00	G PRD2843K	43mm Large Sleeve Mounted Slidelock Reel (D)	£949.00
G PRD2443K	43mm Small Side Wall Mounted Slidelock Reel (E)	£867.00	G PRD2943K	43mm Large Side Wall Mounted Slidelock Reel (E)	£949.00
G PRD200ETBK	38mm T-Model Space Saver Flat-packed (F)	£829.00	G PRD205ETBK	38mm T-Model Space Saver Flat-packed (F)	£911.00

Any fixed domestic end stands can have an additional height added at the price coded.

16mm drill bit needed.

Extensions up to an added 300mm are 1x PRD130S charge, over this and to a maximum of 500mm, 2x PRD130S are to be charged.

**Note:** dimensions on extensions refer to metalwork only.

All plate fixings are 130mm Ø

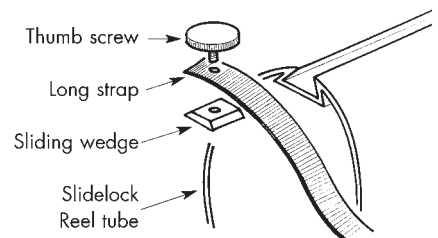
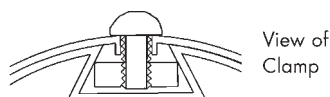
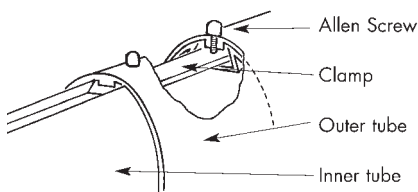

**Note:** Reel systems will incur a Bulky item delivery charge and are excluded from free delivery.

# Slidelock Reel with 3:1 Reduction Gearbox

MADE TO ORDER

BULKY



## 43mm Small Slidelock (complete)

DISCOUNT CODE/ PRODUCT CODE	DESCRIPTION	PRICE EACH
G PRD2043RGK	43mm Small Standard Slidelock Reel with Reduction Gearbox	£1,257.00
G PRD2143RGK	43mm Small Wall Mounted Slidelock Reel with Reduction Gearbox (B) *	£1,257.00
G PRD2243RGK	43mm Small Base Plate Slidelock Reel with Reduction Gearbox (C) *	£1,257.00
G PRD2343RGK	43mm Small Sleeve Mounted Slidelock Reel with Reduction Gearbox (D) *	£1,257.00
G PRD2443RGK	43mm Small Side Wall Mounted Slidelock Reel with Reduction Gearbox (E) *	£1,257.00
G PRD200TWRGK	T-Model (F) (black ABS only)	£1,219.00

- 3:1 reduction makes winding reels easy
- Aerospace industry gearing for strength & reliability



## 43mm Large Slidelock (complete)

DISCOUNT CODE/ PRODUCT CODE	DESCRIPTION	PRICE EACH
G PRD2543RGK	43mm Large Standard Slidelock Reel with Reduction Gearbox (A)	£1,339.00
G PRD2643RGK	43mm Large Wall Mounted Slidelock Reel with Reduction Gearbox (B) *	£1,339.00
G PRD2743RGK	43mm Large Base Plate Slidelock Reel with Reduction Gearbox (C) *	£1,339.00
G PRD2843RGK	43mm Large Sleeve Mounted Slidelock Reel with Reduction Gearbox (D) *	£1,339.00
G PRD2943RGK	43mm Large Side Wall Mounted Slidelock Reel with Reduction Gearbox (E) *	£1,339.00
G PRD205TWRGK	T-Model (F) (black ABS only)	£1,301.00

**Note:** Made to order – check lead times with Customer Services.

# Reduction Gearbox - For Domestic Pools

BULKY



- Revolutionary product
- Fits both of Plastica Slidelock domestic reels
- Discreet and made to match the original boss
- Reduction makes winding reels easy
- Retro-fits to existing Slidelock reels on site
- Comes complete with all necessary tools and instructions
- Aerospace industry gearing for strength & reliability

## Reduction Gearbox

DISCOUNT CODE/ PRODUCT CODE	DESCRIPTION	PRICE EACH
K RGK007	Reduction Gearbox for Slidelock Reel	£281.50



**Note:** Reel systems will incur a Bulky item delivery charge and are excluded from free delivery.

COVERS  
& REELS

# Power Pack 100

**BULKY** **INSTALL**



- Semi-automatic motorisation for domestic reels up to 75sq.m
- Motor fits Plastica Slidelock reel (& Reel Easy using adaptors)
- With built-in Brake, Limit Switches & Variable Start Delay timer
- Includes hand held remote control with up to 30m range
- S.E.L.V. can be mounted in pool area
- Built in battery back-up & 24v DC Power Supply/Charger
- Powerful motor with overload protection and 15m of cable
- Complies with existing wiring regulations
- Safe Extra Low Voltage Control Box for safety (24V DC)
- Charger with 1.8m cable requires 6Amp 230v AC socket
- Cable length 15m

**Notes:** Not suitable for shaped pools. Reel must be permanently fixed down and positioned directly above the water to avoid drag.



## Power Pack 100

DISCOUNT CODE/ PRODUCT CODE	DESCRIPTION	PRICE EACH
K PRD604K	24v Motor System (for Slidelock Reel '97 on)	£2,460.00

## Power Pack 100 Options

DISCOUNT CODE/ PRODUCT CODE	DESCRIPTION	PRICE EACH
K PRD605RB	Remote button controller with 15m cable	£121.00

Microprocessor controlled Control Panel with LCD display that has multiple menu options:

- Variable current limit
- Jammed cover reversing function
- Maximum of 8 radio remote controllers (1 supplied)
- Variable delay for button operated closing
- Variable delay for transmitter closing
- Selectable charger type



**COVERS  
& REELS**

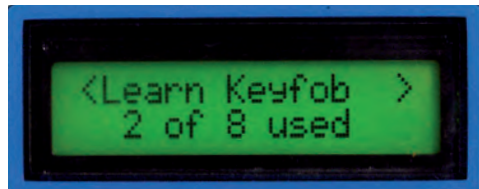
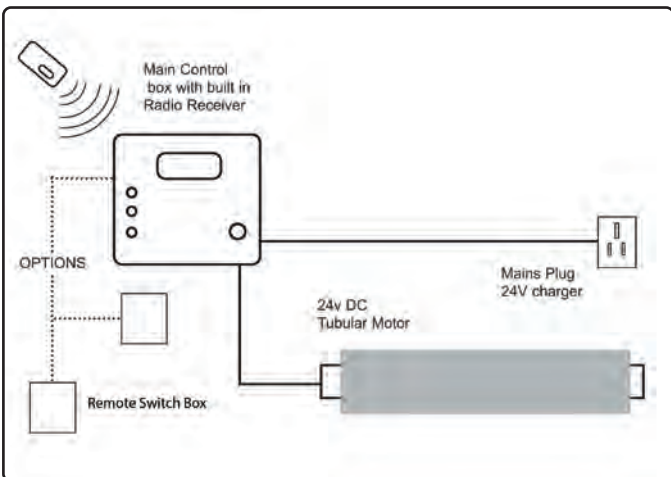

**Note:** Reel systems will incur a Bulky item delivery charge and are excluded from free delivery.



# Slidelock Max Telescopic Reel



Please note: Castors are sold separately



- End bosses and bearings that encapsulates the tube, made from Acetal which has very low friction characteristics and very little moisture absorption
- Stainless steel steering wheel
- Straps connect to tubes by our very popular and unique slide and lock fixing giving full flexibility to the customer
- Anodised aluminium tubes
- Highly polished stainless steel end stands
- Locking device holds the tube in position, stopping the cover from unwinding
- Upgraded T-model, Base Plate & new shaped wall mount end stands
- 24V, Mechanical limit switches, IP68 watertight motor, full instructions available

COVERS  
& REELS



T Width 200mm

Height 410mm

Tube diameter 60mm



Height 412mm

Base width 500mm



Height 297mm

Width 302mm



**Please Note:** Reels should be set up to have a minimum 150mm and maximum 300mm overlap each side. Maximum recommended area of material on both reels is 175sq.m. Cover/ tube overlap should be kept to a minimum. Some flexing of the tube may occur with larger covers.

Motorised systems controlled by key switch as standard with remote upgrades available.



# Slidelock Max Telescopic Reel

**BULKY**

Small Slidelock Max (complete)			Large Slidelock Max (complete)		
DISCOUNT CODE/ PRODUCT CODE	DESCRIPTION	PRICE EACH	DISCOUNT CODE/ PRODUCT CODE	DESCRIPTION	PRICE EACH
K PRD400K	Standard C/W Gearbox	£2,447.00	K PRD405K	Standard C/W Gearbox	£2,512.00
K PRD402K	Base Plate C/W Gearbox	£2,447.00	K PRD407K	Base Plate C/W Gearbox	£2,512.00
K PRD401K	Wall Mount C/W Gearbox	£2,447.00	K PRD406K	Wall Mount C/W Gearbox	£2,512.00
K PRD412K	Base Plate Motorised	£4,704.00	K PRD417K	Base Plate Motorised	£4,770.00
K PRD411K	Wall Mount Motorised	£4,704.00	K PRD416K	Wall Mount Motorised	£4,770.00
			G PRD180	Stainless Steel Castors (48mm tube) pack of 6	£262.00

Following on from our enormously successful Domestic Slidelock System. We are introducing our New Slidelock Max with our upgraded and unique 138mm diameter anodised aluminium tubes, giving us a range from 6.0m to 8.0m for covers up to maximum 7.7m width. (19' 9" to - 25' 3" maximum cover width).

- **Small Slidelock Max** system tubes go from 6.0m to 7.0m, for covers up to a maximum 6.7m width (19' 9" to 23' tubes - 22' maximum cover width)

- **Large Slidelock Max** system tubes go from 7.0m to 8.0m, for covers over 6.7m up to a maximum 7.7m width (23' to 26' 3" tubes - 25' 3" maximum cover width)

Keeping the very popular way our straps connect to tubes by our slide and lock fixing system. Our own locking device holds the tube in position, stopping the cover from unwinding.

The tubes and covers are supported by our new range of end stands made from highly polished 48mm diameter 316 stainless-steel tube. Using Plastica's new special end bosses with our new stainless steering wheel. The new range includes our upgraded T-Model, Base Plate and our shaped wall mount.

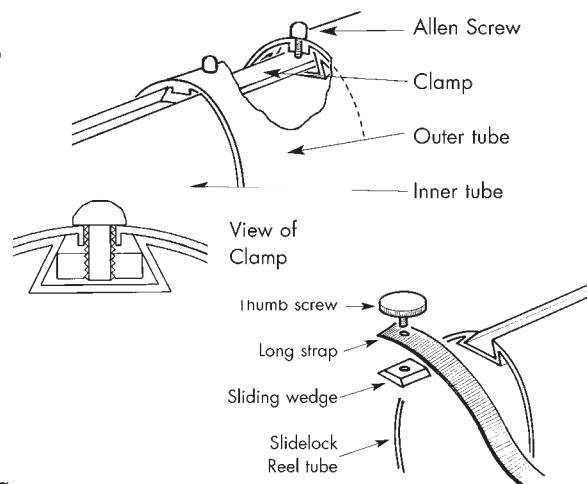

## Premium Reel System for Domestic use

**BULKY**

- Anti-spin locking device on wheels
- Smooth action with sturdy telescopic tube
- Complete with connectors for new or existing covers
- Tube extends from 3.66m to 5.49m
- Maximum area of cover 50 sq.m.
- Straps are 1.5m in length

### In-ground

DISCOUNT CODE/ PRODUCT CODE	DESCRIPTION	PRICE EACH
G2 ERC300	In-Ground	£490.00

- Mobile reel system, 340mm high
- Mobile end stand with 2 wheels
- Static end stand

### Above Ground

DISCOUNT CODE/ PRODUCT CODE	DESCRIPTION	PRICE EACH
G2 ERC310	Above Ground	£527.00

- 2 fixed stands
- Height adjustable from 150mm to 220mm
- Fixes to the pool side

### Decking

DISCOUNT CODE/ PRODUCT CODE	DESCRIPTION	PRICE EACH
G2 ERC320	Decking	£609.00

- 340mm high
- Ideal for wooden pools or decked surrounds
- One fixed end fastens to the surround
- Universal joint enables reel to be moved away from pool side

**Note:** Reel systems will incur a Bulky item delivery charge and are excluded from free delivery.



**COVERS & REELS**

# Helios II™ Solar Reel

BULKY

INSTALL



## HELIOS II

We have continued to develop our solar powered domestic reel system with the Helios II. To improve the end stand installation the back panel is simply removed giving easy access to the securing position at the pool side.

- Totally self contained motorised reel
- For small domestic outdoor Solar covers
- SELV 12V d.c. operation
- Automatic stopping limits
- Comes complete with end stands and tube set
- Simple 3-way key operation
- Solar panel trickle charging
- Small Slidelock style tubes for 3.05m to 4.57m (4.3m maximum cover width)
- Large Slidelock style tubes for 4.88m to 6.1m (5.8m maximum cover width)



**Notes:** Reels should be set up to have a 150mm to 300mm overlap each side. Maximum recommended area of material on both reels is 60m<sup>2</sup> Cover/tube overlap should be kept to a minimum. Some flexing of the tube may occur with larger covers.

### Helios II™ Solar Reel

DISCOUNT CODE/ PRODUCT CODE	DESCRIPTION	PRICE EACH
K PRD301K	Small Helios 3.05 to 4.57 (10' - 15')	£1,716.00
K PRD306K	Large Helios 4.88 to 6.1 (16' - 20')	£1,762.00

COVERS  
& REELS

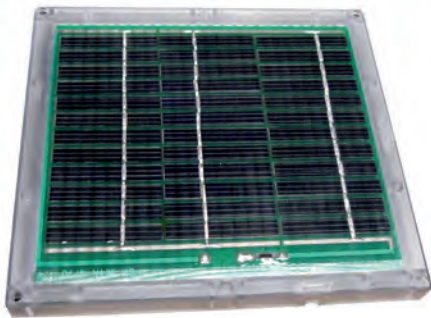

Trickle charged solar panel



Helios II - complete end stand



3-way key operation



## Reflective Storage Cover



- Reduces the temperature of a stored cover by over 30°C
- Extend the life of your cover by protecting from sun damage
- UV stabilised

### Reflective Storage Cover

DISCOUNT CODE/ PRODUCT CODE	DESCRIPTION	PRICE EACH
K PSC801	25m Roll x 1m Wide	£88.00
K PSC820	6m Length	£24.50
K PRD115	Elasticated Quick Fit Strap Kit (pack of 3)	£13.00
K PRD113	140cm Elastic Cord with Toggle Ends (pack of 8)	£17.50

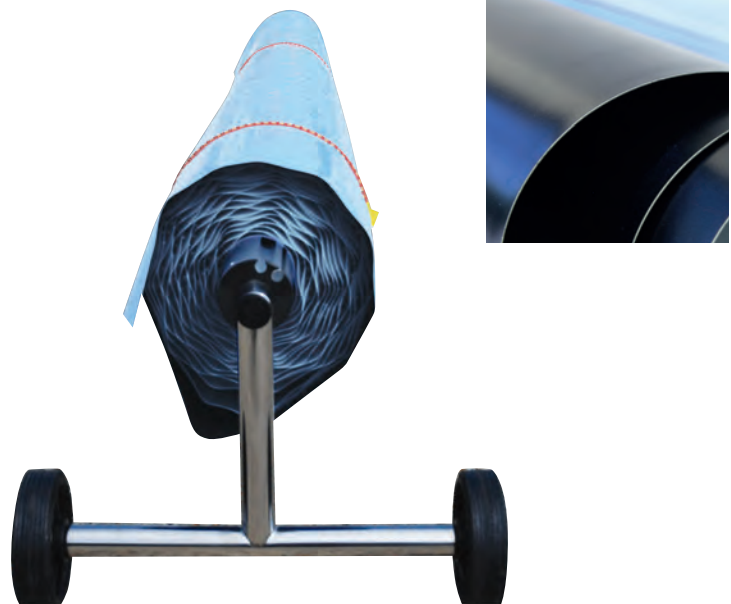
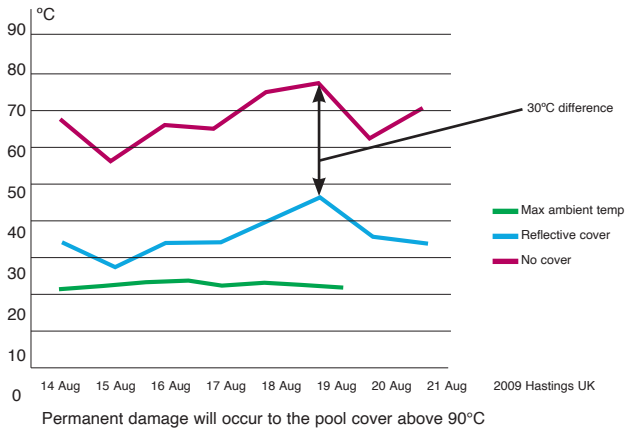

COVERS  
& REELS

## Solar Protector Sheet



### Solar Protector Sheet

DISCOUNT CODE/ PRODUCT CODE	DESCRIPTION	PRICE EACH
R PSC901	25m x 1.22m Roll	£72.50
R PSC920	6m x 1.22m	£19.00
K PRD115	Elasticated Quick Fit Strap Kit (pack of 3)	£13.00
K PRD113	140cm Elastic Cord with Toggle Ends (pack of 8)	£17.50



Strap Kit – PRD115



Elastic Cord with Toggle Ends – PRD113



# Deluxe Reel Protector Cover



## White

DISCOUNT CODE/ PRODUCT CODE	DESCRIPTION	PRICE EACH
G2 PRD215	Small	£144.50
G2 PRD218	Medium	£160.00
G2 PRD222	Large	£178.00
G2 PRD226	Extra Large	£197.00

## Blue

DISCOUNT CODE/ PRODUCT CODE	DESCRIPTION	PRICE EACH
G2 PRD315	Small	£144.50
G2 PRD318	Medium	£160.00
G2 PRD322	Large	£178.00
G2 PRD326	Extra Large	£197.00

- Reinforced PVC
- Protects reel system from the elements
- Made to allow for 355mm steering wheel
- Blue – keeps rain & frost from damaging reel system left outside
- White – reflects sun's rays & harmful UV to protect reel & cover
- Small – reels up to 15'
- Medium – reels up to 18'
- Large – reels up to 22'
- Extra Large – reels up to 26'



COVERS  
& REELS



**Note:** White protector cover comes with blue press fix connectors.

**Note:** Plastica reserve the right to charge for production drawings of bespoke reel systems.



# Commercial Reel Systems



## Fixed Manual

INSTALL MADE TO ORDER HEAVY ITEM

- Suitable for most smaller commercial pools
- Nylon end bosses and anodised tube
- Optional reduction gearbox

- Highly polished stainless steel end stands as standard
- White powder coating available on request
- Approximate weight of each end stand including bearing is 10kg plus 2kg extra per 240mm run of tube

### Tube Packs

DISCOUNT CODE/ PRODUCT CODE	DESCRIPTION	PRICE EACH
J PCR012	▲ 3.66m (12')	£1,032.00
J PCR014	▲ 4.27m (14')	£1,091.00
J PCR016	▲ 4.88m (16')	£1,150.00
J PCR018	▲ 5.49m (18')	£1,210.00
J PCR020	▲ 6.10m (20')	£1,269.00
J PCR022	▲ 6.71m (22')	£1,328.00
J PCR024	▲ 7.32m (24')	£1,395.00
J PCR026	▲ 7.92m (26')	£1,453.00
J PCR028	▲ 8.53m (28')	£1,512.00
J PCR030	▲ 9.14m (30')	£1,579.00
J PCR032	▲ 9.75m (32')	£1,638.00

### End Stands

DISCOUNT CODE/ PRODUCT CODE	DESCRIPTION	PRICE EACH
J PCR002	Baseplate (A)	£483.00
J PCR004	Wallmount (B)	£483.00
J PCR006	Sleeve-Mount (C)	£313.00
J PCR120S	0.3m / 1' Added Height to Reel System (per pair)	£119.00

**Note:** Two End Stands required for every Reel System.

### Fixed Reel with Reduction Gearbox

There is an additional cost of £936.00 per reel when a gearbox is required (covers over 140 sq.m.)

Please add a "G" to the end of the reel code when ordering – i.e. PCR012G

### Surcharges

	Length in metres						
	10	15	20	25	30	33	50
PCR012	0%	0%	0%	0%	0%	0%	A
PCR014	0%	0%	0%	0%	0%	0%	A
PCR016	0%	0%	0%	0%	0%	0%	A
PCR018	0%	0%	0%	0%	0%	0%	A
PCR020	0%	0%	0%	0%	0%	0%	A
PCR022	0%	0%	0%	0%	0%	A	A
PCR024	0%	0%	0%	0%	A	A	
PCR026	0%	0%	0%	A	A		
PCR028	0%	0%	A	A			
PCR030	0%	A	A				
PCR032	0%	A	A				

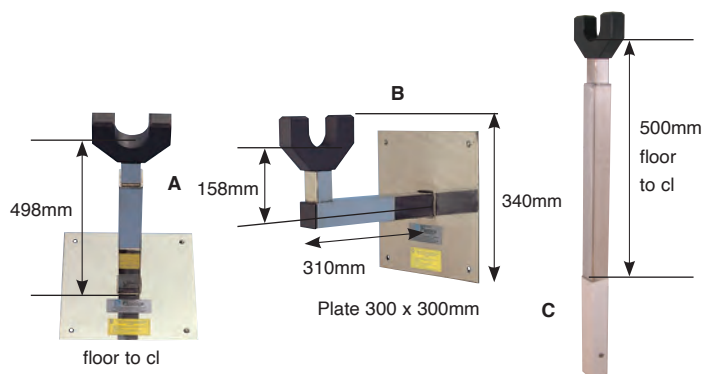

COVERS & REELS

For a quote contact Customer Services on 01424 857802 or email [quote@plasticapools.net](mailto:quote@plasticapools.net)

Delivery for commercial products can be costly. Always ask for a quotation before ordering. Reels should be at least 460mm larger than the cover. Help should be on hand to off-load larger covers upon delivery.

**Note:** Plastica reserve the right to charge for production drawings of bespoke reel systems.

# Piggyback Mobile

INSTALL  
MADE TO ORDER  
HEAVY ITEM



- For pools up to 13.7m wide
- Ideal when two covers are necessary for pools over 9.14m wide
- Dual tubes take two covers supported by a pair of mobile end stands

- Detachable cover with quick-fit snap connectors
- Stainless steel frame with nylon end bosses
- 127mm diameter aluminium tube
- 152mm stainless steel braked castors

COVERS  
& REELS

## Piggyback Mobile

DISCOUNT CODE/ PRODUCT CODE	DESCRIPTION	PRICE EACH
J PPB012	▲ 3.66m (12') - 50m	£4,410.00
J PPB014	▲ 4.27m (14') - 50m	£4,544.00
J PPB016	▲ 4.88m (16') - 50m	£4,677.00
J PPB018	▲ 5.49m (18') - 50m	£4,811.00
J PPB020	▲ 6.10m (20') - 50m	£4,944.00
J PPB022	▲ 6.71m (22') - 34m	£5,078.00
J PPB024	▲ 7.32m (24') - 25m	£5,236.00

## Quick Release Strap Kit

DISCOUNT CODE/ PRODUCT CODE	DESCRIPTION	PRICE EACH
K PPB20013	5' Strap	£11.00
K PPB20014	7' Strap	£14.00

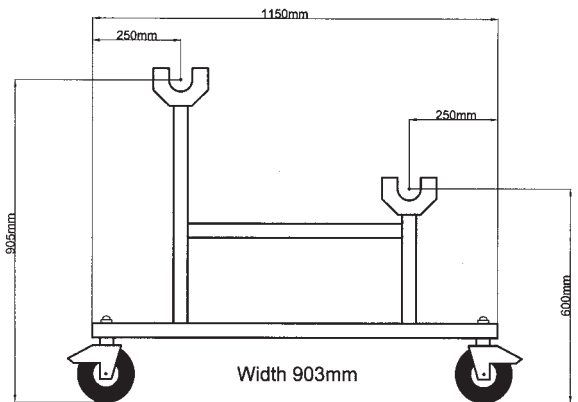

## Piggyback with Reduction Gearbox

There is an additional cost of £1872.00 per reel when gearboxes are required.

Please add a "G" to the end of the reel code when ordering – i.e. PPB012G

For a quote contact Customer Services on 01424 857802 or email [quote@plasticapools.net](mailto:quote@plasticapools.net)

Delivery for commercial products can be costly. Always ask for a quotation before ordering. Reels should be at least 460mm larger than the cover. Help should be on hand to off-load larger covers upon delivery.

**Note:** Plastica reserve the right to charge for production drawings of bespoke reel systems.

# Mobile

INSTALL MADE TO ORDER HEAVY ITEM



- For smaller commercial pools
- Stainless steel frame with nylon end bosses
- 127mm diameter aluminium tube
- 127mm braked castors

## Mobile Reel System

DISCOUNT CODE/ PRODUCT CODE	DESCRIPTION	PRICE EACH
J PPB212	▲ 3.66m (12') - 50m	£2,580.00
J PPB214	▲ 4.27m (14') - 50m	£2,646.00
J PPB216	▲ 4.88m (16') - 50m	£2,712.00
J PPB218	▲ 5.49m (18') - 50m	£2,777.00
J PPB220	▲ 6.10m (20') - 50m	£2,843.00
J PPB222	▲ 6.71m (22') - 34m	£2,909.00
J PPB224	▲ 7.32m (24') - 25m	£2,982.00
J PPB226	▲ 7.92m (26') - 20m	£3,048.00
J PPB228	▲ 8.53m (28') - 17m	£3,114.00
J PPB230	▲ 9.14m (30') - 14m	£3,179.00
J PPB232	▲ 9.75m (32') - 10m	£3,252.00

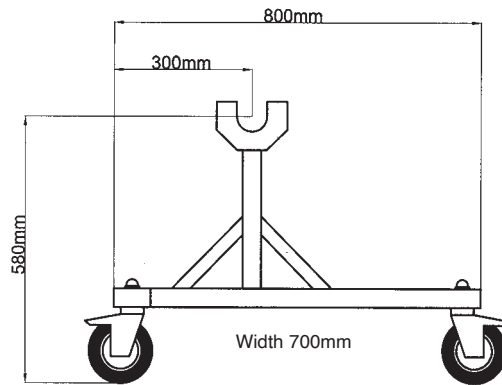

**Note:** If cover length exceeds maximum as indicated then 165mm aluminium tube is required. Phone Customer Services for a quote. Reduction gearbox recommended for covers over 140m<sup>2</sup>.

COVERS & REELS

## Mobile Reel with Reduction Gearbox

There is an additional cost of £936.00 per reel when a gearbox is required.

Please add a "G" to the end of the reel code when ordering – ie. PPB212G

For a quote contact Customer Services on 01424 857802 or email [quote@plasticapools.net](mailto:quote@plasticapools.net)

Delivery for commercial products can be costly. Always ask for a quotation before ordering. Reels should be at least 460mm larger than the cover. Help should be on hand to off-load larger covers upon delivery.

**Note:** Plastica reserve the right to charge for production drawings of bespoke reel systems.



# Commercial Gearbox Converter Kit

INSTALL

MADE TO ORDER

HEAVY ITEM

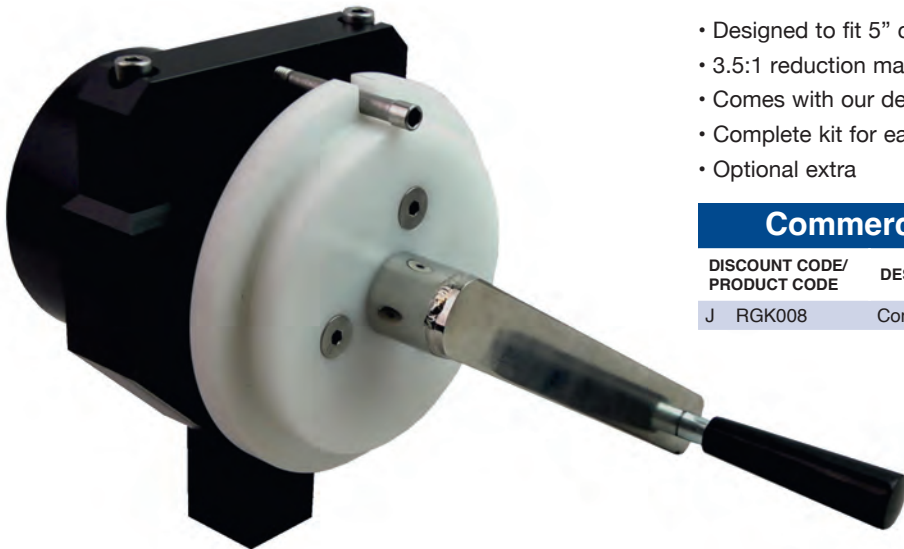

- Designed to fit 5" commercial tubes
- 3.5:1 reduction making it easier to wind the reel
- Comes with our detachable steel crank handle as standard
- Complete kit for easy DIY fitting
- Optional extra

## Commercial Gearbox Converter Kit

DISCOUNT CODE/ PRODUCT CODE	DESCRIPTION	PRICE EACH
J RGK008	Commercial Gearbox Converter Kit	£1,135.00

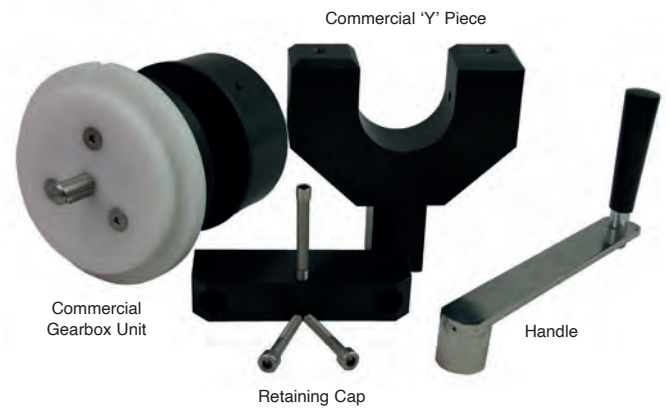

COVERS & REELS

For a quote contact Customer Services on 01424 857802 or email [quote@plasticapools.net](mailto:quote@plasticapools.net)

Delivery for commercial products can be costly. Always ask for a quotation before ordering. Reels should be at least 460mm larger than the cover. Help should be on hand to off-load larger covers upon delivery.

**Note:** Plastica reserve the right to charge for production drawings of bespoke reel systems.

# Nazca Pool Safety Cover

*The perfect addition to your Nazca pool...*

- Simple to install
- Prevents ingress of debris
- Low maintenance
- Blocks light into the pool (minimising the use of water treatment)



New for 2022

See p.194 for product details



# Full Commercial Stanchion Motorised

INSTALL

MADE TO ORDER

HEAVY ITEM



- Ultra quiet motors with soft start - soft stop mechanism
- 304mm diameter stainless steel tubing
- Maximum cover capacity of 600m<sup>2</sup>
- 14m maximum tube length.
- Key switch and remote control operation
- Auto stop end of run settings



COVERS & REELS



For a quote contact Customer Services on 01424 857802 or email [quote@plasticapools.net](mailto:quote@plasticapools.net)

Delivery for commercial products can be costly. Always ask for a quotation before ordering. Reels should be at least 460mm larger than the cover.

Help should be on hand to off-load larger covers upon delivery.

**Note:** Plastica reserve the right to charge for production drawings of bespoke reel systems.



# Light Commercial Motorised

INSTALL MADE TO ORDER HEAVY ITEM



- Ideal for small commercial swimming pools
- Ultra quiet motors with soft start - soft stop mechanism
- Manufactured from stainless steel
- Maximum cover size 17m<sup>2</sup>
- 9m maximum standard tube length
- 168mm tube diameter
- Key switch and remote control
- Auto stop end of run settings



For a quote contact Customer Services on 01424 857802 or email [quote@plasticapools.net](mailto:quote@plasticapools.net)

COVERS & REELS

# Wind Resistant Wires

INSTALL MADE TO ORDER HEAVY ITEM



- Recommended for Commercial outdoor Heat Retention Covers
- Helps protect from lifting in winds up to Gale Force 5 (30km/h)
- Stainless steel wire fitted inside hemming and fixed at pool ends
- Requires wires on lengths and widths, together with two of each end fitting kit

**Notes:** Wires can only be fitted at the time of manufacture. Not guaranteed to make a pool cover windproof. Covers should be stored on a reel system in winds over Gale Force 5 (30km/h)



## Wind Resistant Wires

DISCOUNT CODE/ PRODUCT CODE	DESCRIPTION	PRICE EACH
J WRW001	Wind Wires per linear meter	£6.60
K WRT001	Towing End Fitting Kit	£468.00
K WRR001	Reel End Fitting Kit	£405.00

Towing End - Length Fixing

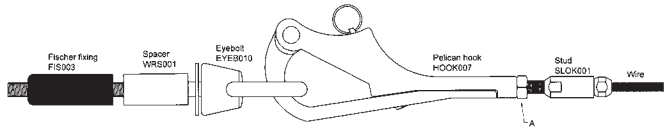

Towing End - Width Fixing



Reel End - Length Fixing

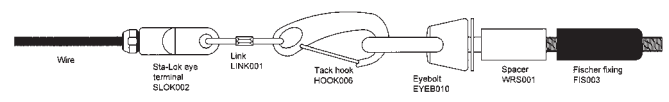

Reel End - Width Fixing



For a quote contact Customer Services on 01424 857802 or email [quote@plasticapools.net](mailto:quote@plasticapools.net)

# Plastica Poolsaver® Cover for Wooden Pools

INSTALL SPECIAL ORDER HEAVY ITEM



- Flush fit brass anchors
- Stainless Steel ratchets
- Easy to install
- Made from UV Stabilised PVC coated Polyester
- Beige non-marking underside on all cover colours
- Anodised aluminium tubes 44mm



## Poolsaver® Manual Safety Cover

DISCOUNT CODE/ PRODUCT CODE	DESCRIPTION	PRICE EACH
V PSW100*	Poolsaver Manual Safety Cover per m <sup>2</sup>	£82.61
V LPDA001	Low Profile Deck Anchor	£7.80
V PIN002	Decking Fixings (for decked pools)	£5.66

**Note:** Minimum charge £2812.00

## Standard Size Wooden Poolsaver® Covers\*

PRODUCT CODE	POOL SIZE	APPROX. COVER SIZE	PRICE EACH
PSV101	Knightsbridge/ Small Eco	4.213m x 4.213m	£2,812.00
PSV201	Mayfair	5.129m x 5.129m	£2,812.00
PSV301	Richmond	3.789m x 3.826m	£2,812.00
PSV801	Hampstead	5.600m x 5.600m	£2,812.00
PSV401	Belgravia	6.082m x 4.212m	£2,812.00
PSV501	Bayswater	7.082m x 4.212m	£2,812.00
PSV601	Westminster	8.719m x 5.129m	£3,717.45
PSV701	Exercise	4.434m x 2.994m	£2,812.00
PSV1011	Chelsea	10.518m x 5.518m	£4,791.00

**\*Note:** Please add GY for grey, B for blue, BG for beige, G for Green and PG for Pastel Green onto the end of the code PSW100 for Poolsaver cover colours.



PSL600AKR Removable ladder



PIN002 Decking Fixings

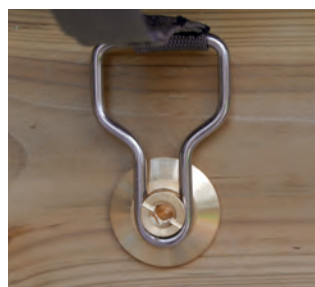

LPDA001 Low Profile Anchor



Stainless Steel Ratchet

COVERS & REELS



# Plastica Poolsaver® Manual Safety Cover

INSTALL SPECIAL ORDER HEAVY ITEM

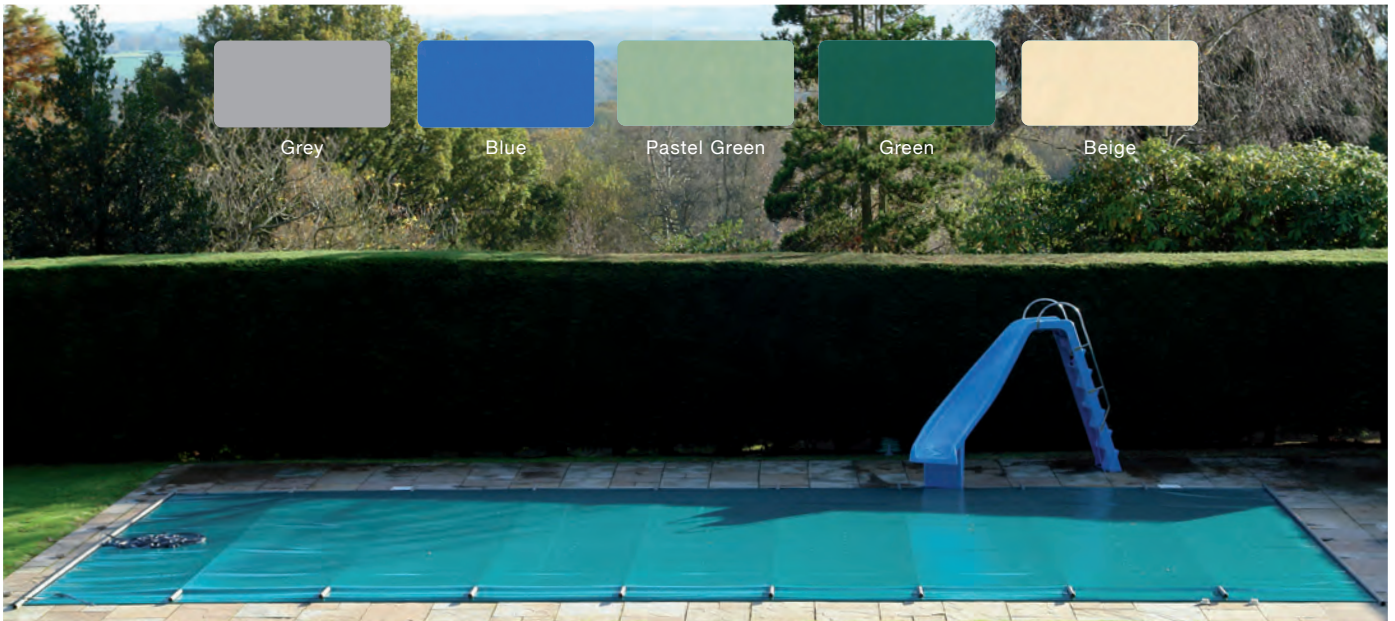

- Easy to install
- Made from UV stabilised PVC coated polyester
- Extra reinforced underside reduces wear from coping stones
- Supplied complete with manual winder  
Two winders supplied for covers 5m x 10m and over
- Cover should overhang by 30cm all round pool
- Beige - non-marking underside on all cover colours



100kg max weight



## Standard Size Poolsaver Covers

DISCOUNT CODE/ PRODUCT CODE	POOL SIZE	APPROX. COVER SIZE
V ▲	12' x 24'	14' x 26' 34m <sup>2</sup>
V ▲	14' x 28'	16' x 30' 45m <sup>2</sup>
V ▲	15' x 30'	17' x 32' 51m <sup>2</sup>
V ▲	16' x 32'	18' x 34' 57m <sup>2</sup>
V ▲	18' x 36'	20' x 38' 71m <sup>2</sup>
V ▲	20' x 40' (Maximum)	83m <sup>2</sup>

## Poolsaver Manual Safety Cover

DISCOUNT CODE/ PRODUCT CODE	DESCRIPTION	PRICE EACH
V ▲ PSV100*	Poolsaver Manual Safety Cover per m <sup>2</sup>	£55.55
V ▲ PSTEP1	Step Section on width of pool up to 3.5m dia	£686.00
V ▲ PSTEP2	Step Section on width of pool of 3.5m dia	£753.00
V ▲ SCW100K	Manual Cover Winder (Spare part)	£230.00
V ▲ PIN001	14MM Ground Fixing Pin (Spare part)	£5.66
V ▲ PIN002	Decking Fixings	£5.66

**Note:** Maximum cover width is 6.7m.

**Note:** Please add GY for grey, B for blue, BG for beige, G for Green and PG for Pastel Green onto the end of the code PSV100 for Poolsaver cover colours.

▲ Extra carriage. Please contact Customer Services on 01424 857802 for a delivery quote.

Minimum list price will be £1444.00 for pools smaller than 12' x 24' [Call Customer Services on 01424 857802 for a product quote](#)

## Rolltrot Cover Winding System

SPECIAL ORDER

- Assists with opening only of the pool cover
- Wired remote control
- Complete with battery charger
- Direct replacement for the Droopi and Easy Pro 4
- Max dimensions of cover: 5.5m x 12m or 6m x 11.5m



### Rolltrot

DISCOUNT CODE/ PRODUCT CODE	DESCRIPTION	PRICE EACH
NETT APF500K	Electric Cover Winding System	£700.00

**Note:** Prices above are nett – trade discounts are not available for this product.



## Winter Debris Covers



- Reduces frost damage
- Minimises discolouration caused by leaves and other debris
- Woven polyethylene
- UV stabilised
- Green/black finish
- Plugs provided for holes when not in use
- 170gsm
- 10 year pro rata warranty

**Notes:** When calculating cover prices add an extra 60cm to each dimension and round up to the nearest square metre.

Strap spacing is normally between 0.91m-1.5m on the width and 1.2m-1.5m along the length.

15% surcharge added for straps at 0.91m spacing. 40% surcharge added for straps at 0.6m spacing.

The water level within the pool should be monitored regularly during the winter and reduced whenever necessary.

## Deluxe Covers

MADE TO ORDER



COVERS & REELS

- Totally removable in the summer
- P-anchor requires a 6mm drill bit

### Deluxe Debris Covers

DISCOUNT CODE/ PRODUCT CODE	DESCRIPTION	PRICE EACH
I PWD101	Rectangular per m <sup>2</sup>	£26.70
I PWD110	10' x 20' (25m <sup>2</sup> )	£667.50
I PWD112	12' x 24' (34m <sup>2</sup> )	£907.80
I PWD114	14' x 28' (45m <sup>2</sup> )	£1,201.50
I PWD115	15' x 30' (51m <sup>2</sup> )	£1,361.70
I PWD116	16' x 32' (57m <sup>2</sup> )	£1,521.90
I PWD118	18' x 36' (71m <sup>2</sup> )	£1,895.70
I PWD120	20' x 40' (86m <sup>2</sup> )	£2,296.20

### Shaping Charges

DISCOUNT CODE/ PRODUCT CODE	DESCRIPTION	PRICE EACH
I SHWDDS	Shaping surcharge per m <sup>2</sup>	£3.60

### Including 5' Radius Roman End

DISCOUNT CODE/ PRODUCT CODE	DESCRIPTION	PRICE EACH
I PWD112R	12' x 24' (40m <sup>2</sup> )	£1,068.00
I PWD114R	14' x 28' (52m <sup>2</sup> )	£1,388.40
I PWD115R	15' x 30' (58m <sup>2</sup> )	£1,548.60
I PWD116R	16' x 32' (65m <sup>2</sup> )	£1,732.50
I PWD118R	18' x 36' (80m <sup>2</sup> )	£2,136.00
I PWD120R	20' x 40' (96m <sup>2</sup> )	£2,563.20

**Note:** All sizes stated are pool sizes.



## Flush-Fix Debris Covers

MADE TO ORDER

- Brass flush fix anchor with stainless steel spring for tensioning the cover
- Screws back into outer casing when not in use
- Requires a 20mm drill bit

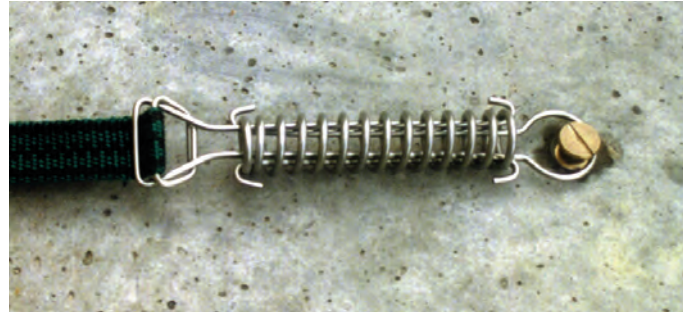

### Flush-Fix Debris Covers

DISCOUNT CODE/ PRODUCT CODE	DESCRIPTION	PRICE EACH
I PWD301	Rectangular per m <sup>2</sup>	£28.00
I PWD401	Criss-Cross per m <sup>2</sup>	£31.40

### Shaping Charges

DISCOUNT CODE/ PRODUCT CODE	DESCRIPTION	PRICE EACH
I SHWDDS	Shaping surcharge per m <sup>2</sup> for shaped pools	£3.60

No Shaping Charges for Roman Ends

## Premium Debris Covers

MADE TO ORDER

- Stainless steel D ring and buckle
- Totally removable in the summer season
- Ideal for restricted areas
- Requires a 6mm drill bit



### Debris Covers

DISCOUNT CODE/ PRODUCT CODE	DESCRIPTION	PRICE EACH
I PWD501	Rectangular per m <sup>2</sup>	£26.27
I PWD601	Criss-Cross per m <sup>2</sup>	£29.69

### Shaping Charges

DISCOUNT CODE/ PRODUCT CODE	DESCRIPTION	PRICE EACH
I SHWDDS	Shaping surcharge per m <sup>2</sup> for shaped pools	£3.60

No Shaping Charges for Roman Ends

## Low Profile Decking Covers

MADE TO ORDER

- Low profile brass fittings
- Pin screws flush with fitting when not in use
- Stainless steel spring for tensioning the cover
- Requires a 20mm drill bit

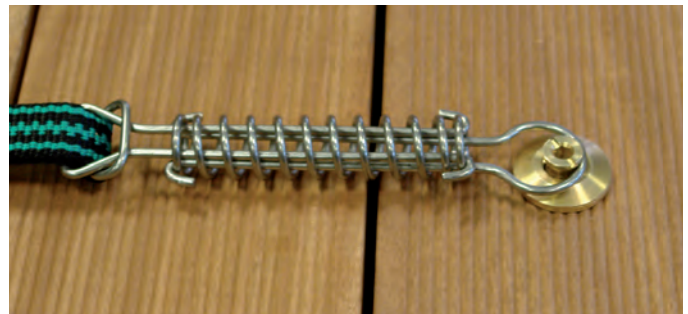

### Low Profile Decking Covers

DISCOUNT CODE/ PRODUCT CODE	DESCRIPTION	PRICE EACH
I PWD901	Rectangular per m <sup>2</sup>	£28.45
I PWD951	Criss-Cross per m <sup>2</sup>	£31.84

### Shaping Charges

DISCOUNT CODE/ PRODUCT CODE	DESCRIPTION	PRICE EACH
I SHWDDS	Shaping surcharge per m <sup>2</sup> for shaped pools	£3.60

No Shaping Charges for Roman Ends

# Deluxe Criss Cross Debris Covers



## Deluxe Criss Cross

DISCOUNT CODE/ PRODUCT CODE	DESCRIPTION	PRICE EACH
I PWD201	Rectangular per m <sup>2</sup>	£30.14
I PWD250	10' x 20' (25m <sup>2</sup> )	£753.50
I PWD253	12' x 24' (34m <sup>2</sup> )	£1,024.76
I PWD255	14' x 28' (45m <sup>2</sup> )	£1,356.30
I PWD257	15' x 30' (51m <sup>2</sup> )	£1,537.14
I PWD259	16' x 32' (57m <sup>2</sup> )	£1,717.98
I PWD263	18' x 36' (71m <sup>2</sup> )	£2,139.94
I PWD265	20' x 40' (86m <sup>2</sup> )	£2,592.04

## Including 5' Radius Roman End

DISCOUNT CODE/ PRODUCT CODE	DESCRIPTION	PRICE EACH
I PWD201	Rectangular per m <sup>2</sup>	£30.14
I PWD253R	12' x 24' (40m <sup>2</sup> )	£1,205.60
I PWD255R	14' x 28' (52m <sup>2</sup> )	£1,567.28
I PWD257R	15' x 30' (58m <sup>2</sup> )	£1,748.12
I PWD259R	16' x 32' (65m <sup>2</sup> )	£1,959.10
I PWD263R	18' x 36' (80m <sup>2</sup> )	£2,411.20
I PWD265R	20' x 40' (96m <sup>2</sup> )	£2,893.44

All sizes stated are pool sizes

## Shaping Charges

DISCOUNT CODE/ PRODUCT CODE	DESCRIPTION	PRICE EACH
II SHWDDS	Shaping surcharge per m <sup>2</sup> for shaped pools	£3.60

**Note:** Ask for our measuring guide booklet and form if you are unsure how to size up your cover.  
A measuring service is available by our surveyor for UK Mainland – see page 6 for further details.

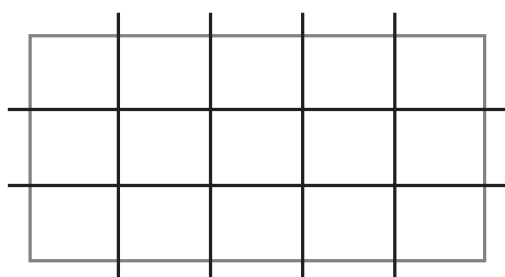

Criss Cross Maximum size:

50' x 22' (15.24m x 6.71m)

For larger sizes, contact Customer Services

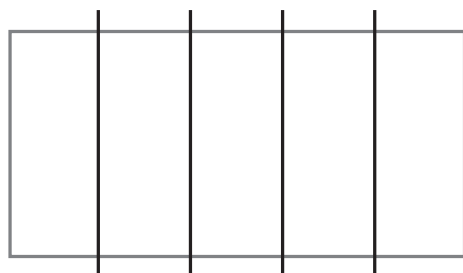

Width Only Maximum size:

90' x 40' (27.43m x 12.19m)

For larger sizes, contact Customer Services

### Important Please Note

We highly advise against shaped pools having a Criss Cross cover (excluding bays and roman ends). This is due to the way the straps are fitted and tensioned on site. As these straps are not at 90° from the cover they can cause the cover to look misshaped, this is not a valid warranty claim. We reserve the right to refuse to manufacture.

## Optional Extras



Bay Shaping

Optional Extras		
DISCOUNT CODE/ PRODUCT CODE	DESCRIPTION	PRICE EACH
I CUTWDS	Ladder Cut-Outs (per pair)	£90.00
I PWD701	Debris Cover per m <sup>2</sup> with Straps (no fixings)	£25.84
I PWD751	Criss-Cross Cover per m <sup>2</sup> with Straps (no fixings)	£29.77
I PWD850	Leaf Seal Skirt with Fixings per linear metre	£81.84
I PWD800	0.5m Wide Reinforcing Strip per linear metre	£22.58
I EXTWDS	1m Extra Long Straps - surcharge per cover	£95.00
I SHWDDS	Shaping surcharge per m <sup>2</sup>	£3.60
I SHWDS	Charge for Shaping Small Bay	£62.00
K STA003	500mm Stainless Steel Ground Stake	£4.48
K STA004	Deluxe 450mm Aluminium Ground Stake	£8.54

**Note:** There will be a 15% surcharge for straps at 0.91m spacings.



Criss Cross Material – PWD751

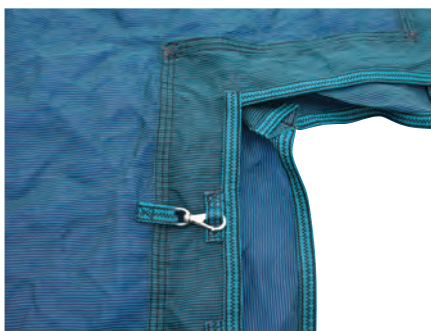

Leaf Seal Skirt – PWD850



Ladder Cut-Out – CUTWD



Deluxe Ground Stake – STA004



Ground Stake – STA003

## Debris Cover Repair Service

Covers needing repair should be returned during the 'off-season' (before the 1st August). We are unlikely to be able to repair covers between the months of September and November.

The cover should be clean and dry with all springs removed.

Should you choose not to proceed with a repair or order a replacement cover, a fee of £75 will be charged.



### Important Please Note

If a repair cannot be done and a new cover is made using the returned cover as a template, we cannot guarantee a perfect match in shape, size and strap positions. This is due to the old covers being stretched and warped from their original shape and size. Every effort is made to make the cover as close as possible but due to this it will not be a valid warranty claim if it does not match. If the template is not suitable to be used, a three point survey will be required.



## Grey Winter Debris Covers

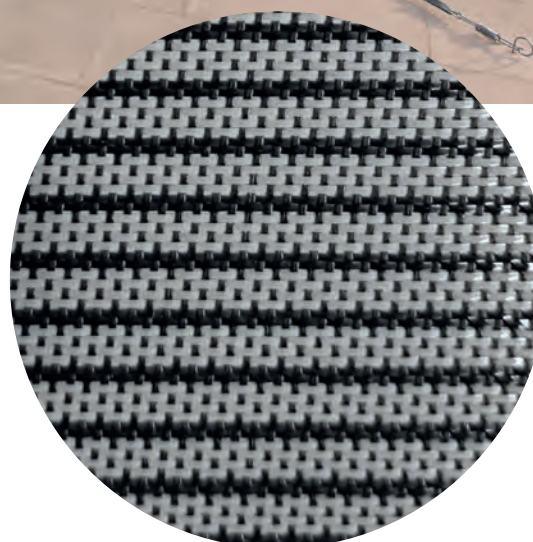

- Reduces frost damage
- Minimises discolouration caused by leaves and other debris
- Tough woven polyethylene mesh
- Grey/black finish
- Plugs provided for holes when not in use
- 140gsm
- 10 year pro rata warranty

Notes: When calculating cover prices add an extra 60cm to each dimension and round up to the nearest square metre.

Strap spacing is normally between 0.91m-1.5m on the width and 1.2m-1.5m along the length.

15% surcharge added for straps at 0.91m spacing. 40% surcharge added for straps at 0.6m spacing.

### Grey Debris Covers

DISCOUNT CODE/ PRODUCT CODE	DESCRIPTION	PRICE EACH
I GWD100	Grey Winter Debris Deluxe per m <sup>2</sup>	£30.00
I GWD200	Grey Winter Debris Deluxe Criss Cross per m <sup>2</sup>	£33.90
I GWD300	Grey Winter Debris Flush Fix per m <sup>2</sup>	£31.40
I GWD400	Grey Winter Debris Flush Fix Criss Cross per m <sup>2</sup>	£35.30
I GWD500	Grey Winter Debris Premium per m <sup>2</sup>	£29.50
I GWD600	Grey Winter Debris Premium Criss Cross per m <sup>2</sup>	£33.40
I GWD900	Grey Winter Debris Low Profile Decking Cover per m <sup>2</sup>	£35.70
I GWD901	Grey WDC Low Profile Decking Criss Cross Cover per m <sup>2</sup>	£35.90
I GWD701	Debris Cover per sq.m. with Straps (no fixings)	£25.60
I GWD751	Criss-Cross Cover per sq.m. with Straps (no fixings)	£29.50

### Shaping Charges

DISCOUNT CODE/ PRODUCT CODE	DESCRIPTION	PRICE EACH
I SHWDDS	Shaping surcharge per m <sup>2</sup>	£3.60

COVERS  
& REELS

# Water Tubes

- Easy method to secure debris cover
- No drilling or permanent installation required

## Water Tubes

DISCOUNT CODE/ PRODUCT CODE	DESCRIPTION	PRICE EACH
V PWL103	Blue 1148mm (3ft 6in)	£20.00
V PWL107	Blue 2286mm (7ft 6in)	£28.00
V ACC18DUBLUE	Double 2286mm (7ft 6in)	£26.00



# Opaque Debris Cover - Eyelet Version



- Bungee straps spaced every 1m
- Hemmed edge
- Corner wear pads
- 650gsm
- Prevents trip hazard

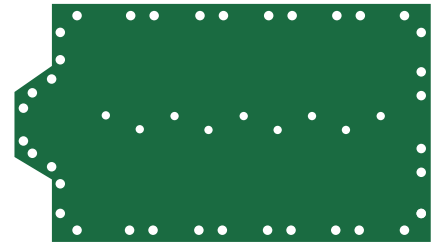
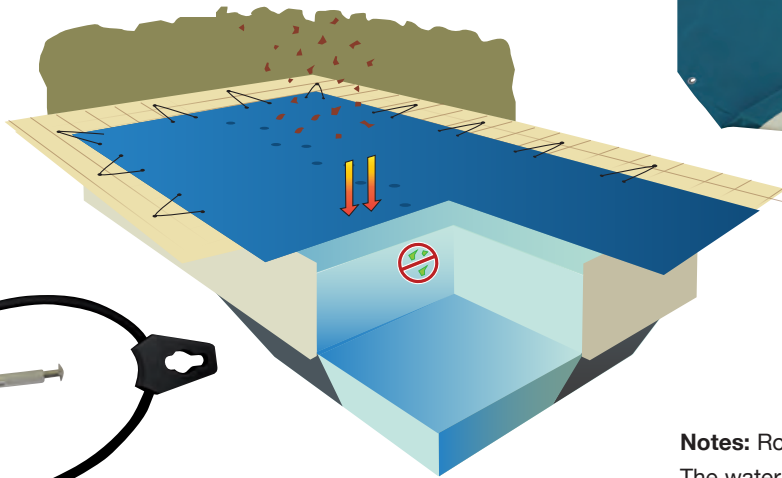
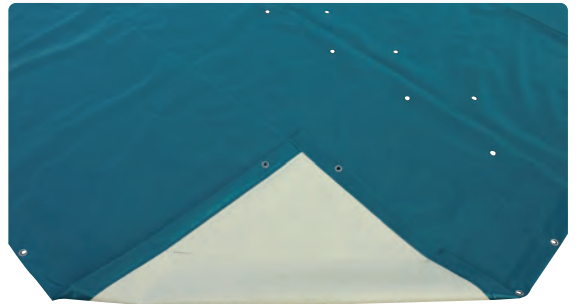

**Notes:** Roman End section will be shaped as shown. The water level within the pool should be monitored regularly during the winter and reduced whenever necessary.

## Opaque Debris Covers - Green

DISCOUNT CODE/ PRODUCT CODE	DESCRIPTION	PRICE EACH
I2 OWDB100G	Rectangular per m <sup>2</sup> (with eyelets & bungees)	£22.35
	12' x 24' (34m <sup>2</sup> )	
	14' x 28' (45m <sup>2</sup> )	
	15' x 30' (51m <sup>2</sup> )	
	16' x 32' (57m <sup>2</sup> )	
	18' x 36' (71m <sup>2</sup> )	
	20' x 40' (86m <sup>2</sup> )	

## Opaque Debris Covers - Blue

DISCOUNT CODE/ PRODUCT CODE	DESCRIPTION	PRICE EACH
I2 OWDB100B	Rectangular per m <sup>2</sup> (with eyelets & bungees)	£22.35
	12' x 24' (34m <sup>2</sup> )	
	14' x 28' (45m <sup>2</sup> )	
	15' x 30' (51m <sup>2</sup> )	
	16' x 32' (57m <sup>2</sup> )	
	18' x 36' (71m <sup>2</sup> )	
	20' x 40' (86m <sup>2</sup> )	

## Shaping Charges

DISCOUNT CODE/ PRODUCT CODE	DESCRIPTION	PRICE EACH
I SHWDDS	Shaping surcharge per m <sup>2</sup> for shaped pools	£3.60

**Note:** All sizes stated are pool sizes.

COVERS & REELS

# Opaque Debris Cover - Strap Version

- Webbing straps spaced every 1.4m
- Hemmed edge
- Corner wear pads
- 650gsm

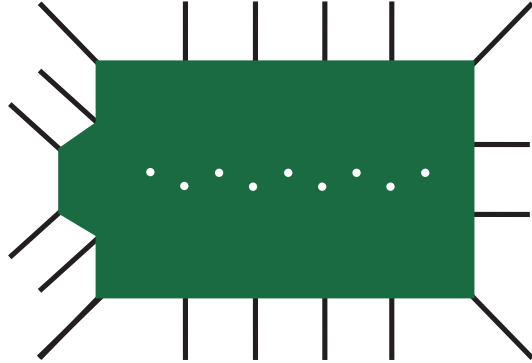

**Note:** Roman End section will be shaped as shown.



## Opaque Debris Covers - Deluxe Green

DISCOUNT CODE/ PRODUCT CODE	DESCRIPTION	PRICE EACH
I2 OWDS101G	Rectangular per m <sup>2</sup> (with straps)	£28.25
	12' x 24' (34m <sup>2</sup> )	
	14' x 28' (45m <sup>2</sup> )	
	15' x 30' (51m <sup>2</sup> )	
	16' x 32' (57m <sup>2</sup> )	
	18' x 36' (71m <sup>2</sup> )	
	20' x 40' (86m <sup>2</sup> )	

## Opaque Debris Covers - Deluxe Blue

DISCOUNT CODE/ PRODUCT CODE	DESCRIPTION	PRICE EACH
I2 OWDB101B	Rectangular per sq.m. (with straps)	£28.25
	12' x 24' (34m <sup>2</sup> )	
	14' x 28' (45m <sup>2</sup> )	
	15' x 30' (51m <sup>2</sup> )	
	16' x 32' (57m <sup>2</sup> )	
	18' x 36' (71m <sup>2</sup> )	
	20' x 40' (86m <sup>2</sup> )	

## Opaque Debris Covers - Flush Fix Green

DISCOUNT CODE/ PRODUCT CODE	DESCRIPTION	PRICE EACH
I2 OWDS301G	Rectangular per m <sup>2</sup> (with straps)	£29.15
	12' x 24' (34m <sup>2</sup> )	
	14' x 28' (45m <sup>2</sup> )	
	15' x 30' (51m <sup>2</sup> )	
	16' x 32' (57m <sup>2</sup> )	
	18' x 36' (71m <sup>2</sup> )	
	20' x 40' (86m <sup>2</sup> )	

## Opaque Debris Covers - Flush Fix Blue

DISCOUNT CODE/ PRODUCT CODE	DESCRIPTION	PRICE EACH
I2 OWDB301B	Rectangular per sq.m. (with straps)	£29.15
	12' x 24' (34m <sup>2</sup> )	
	14' x 28' (45m <sup>2</sup> )	
	15' x 30' (51m <sup>2</sup> )	
	16' x 32' (57m <sup>2</sup> )	
	18' x 36' (71m <sup>2</sup> )	
	20' x 40' (86m <sup>2</sup> )	

## Opaque Debris Covers - Premium Green

DISCOUNT CODE/ PRODUCT CODE	DESCRIPTION	PRICE EACH
I2 OWDS501G	Rectangular per m <sup>2</sup> (with straps)	£28.65
	12' x 24' (34m <sup>2</sup> )	
	14' x 28' (45m <sup>2</sup> )	
	15' x 30' (51m <sup>2</sup> )	
	16' x 32' (57m <sup>2</sup> )	
	18' x 36' (71m <sup>2</sup> )	
	20' x 40' (86m <sup>2</sup> )	

## Opaque Debris Covers - Premium Blue

DISCOUNT CODE/ PRODUCT CODE	DESCRIPTION	PRICE EACH
I2 OWDB501B	Rectangular per sq.m. (with straps)	£28.60
	12' x 24' (34m <sup>2</sup> )	
	14' x 28' (45m <sup>2</sup> )	
	15' x 30' (51m <sup>2</sup> )	
	16' x 32' (57m <sup>2</sup> )	
	18' x 36' (71m <sup>2</sup> )	
	20' x 40' (86m <sup>2</sup> )	

**Note:** All sizes stated are pool sizes

**Note:** All sizes stated are pool sizes

## Shaping Charges

DISCOUNT CODE/ PRODUCT CODE	DESCRIPTION	PRICE EACH
II SHWDDS	Shaping surcharge per m <sup>2</sup> for shaped pools	£3.60

## Shaping Charges

DISCOUNT CODE/ PRODUCT CODE	DESCRIPTION	PRICE EACH
I SHWDDS	Shaping surcharge per sq.m. for shaped pools	£3.60

## Non-standard Size Winter Debris Covers Pricing Formula

Find the diagram or description that corresponds with your pool shape. Follow the calculation method to find the Chargeable Area to the nearest m<sup>2</sup>. Multiply the Chargeable Area by the cover price, then add any necessary shaping charges. Debris covers are calculated as pool size plus 0.6m (0.3m or 1' overlap to every side).

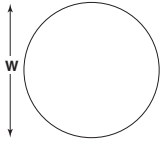
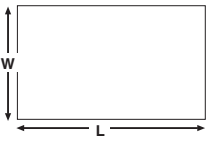
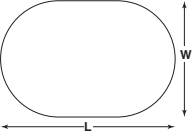
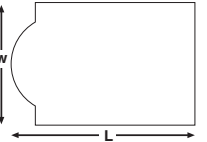
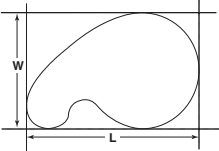
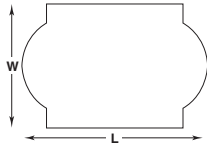
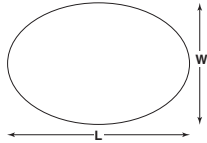
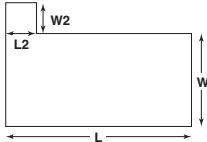
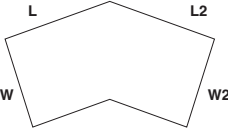
COVER SHAPE	CALCULATION	COVER SHAPE	CALCULATION
ANY SHAPE OF COVER with LADDER CUT-OUTS	<b>Cover Price =</b> Cover Area (CA) x Price per m <sup>2</sup> PLUS 1 x Cut-Out Charge <b>CUTWDS</b> per ladder		<b>CIRCULAR</b>  <b>CA = W x W</b> Cover Price = CA x (Price per m <sup>2</sup> + <b>SHWDDS</b> Shaping surcharge per m <sup>2</sup> )
	<b>RECTANGULAR</b>  <b>CA = L x W</b> Cover Price = CA x Price per m <sup>2</sup>		<b>OVAL</b>  <b>CA = L x W</b> Cover Price = CA x (Price per m <sup>2</sup> + <b>SHWDDS</b> Shaping surcharge per m <sup>2</sup> )
	<b>ROMAN END</b>  <b>CA = L x W</b> Cover Price = CA x Price per m <sup>2</sup>		<b>FREEFORM/KIDNEY</b>  <b>CA = L x W</b> Cover Price = CA x (Price per m <sup>2</sup> + <b>SHWDDS</b> Shaping surcharge per m <sup>2</sup> )
	<b>DOUBLE ROMAN END</b>  <b>CA = L x W</b> Cover Price = CA x Price per m <sup>2</sup>		<b>SHAPED OVAL/PEAR</b>  <b>CA = L x W</b> Cover Price = CA x (Price per m <sup>2</sup> + <b>SHWDDS</b> Shaping surcharge per m <sup>2</sup> )
	<b>WALK IN STAIRS/BAYS</b>  <b>CA = L x W + (L2 x W2)</b> Cover Price = CA x Price per m <sup>2</sup> Add 1 x <b>SHWDS</b> Charge for Bay Shaping		<b>DOG LEG/LAZY 'L'</b>  <b>CA = L x W + (L2 x W2)</b> Cover Price = CA x (Price per m <sup>2</sup> + <b>SHWDDS</b> Shaping surcharge per m <sup>2</sup> )

COVERS & REELS



**CELEBRATING**  
 1972 ~ 2022  
**50 YEARS**  
**OF TRADING**

  
 www.plasticapools.net



# Deluxe Above Ground Pool Covers

- New made to measure Above Ground Pool covers
- Choice of two materials as below
- Mesh Weave material that allows rainwater to pass through
- Deluxe Tarpaulin material that blocks all debris and light
- Use during the Summer or Winter
- Comes complete with elasticated tie-downs and wall clips



## Deluxe Above Ground Pool Covers

DISCOUNT CODE/ PRODUCT CODE	DESCRIPTION	PRICE EACH
I2 PWD100	Mesh Weave Above Ground Debris per m <sup>2</sup>	£19.80
I2 PWD200	Deluxe Tarpaulin Above Ground Debris per m <sup>2</sup>	£21.15

**Note:** Pool water collecting on top of the cover should be monitored over the winter and removed regularly using a pump, syphon, brush or other method.

# Intex Winter Covers



COVERS & REELS

## Easy Set

DISCOUNT CODE/ PRODUCT CODE	DESCRIPTION	PRICE EACH
L 28020	Intex Winter Debris Cover 8ft Ø	£11.50
L 28022/E	Intex Winter Debris Cover 12ft Ø	£18.00
L 28023/E	Intex Winter Debris Cover 15ft Ø	£25.00

## Metal Frame

DISCOUNT CODE/ PRODUCT CODE	DESCRIPTION	PRICE EACH
L 28031	Intex Winter Debris Cover 12ft Ø	£21.50
L 28032	Intex Winter Debris Cover 15ft Ø	£30.00

## Above Ground Winter Covers

- Woven polyethylene
- Comes complete with Winch and Cable

### Above Ground WDC Oval

DISCOUNT CODE/ PRODUCT CODE	DESCRIPTION	PRICE EACH
L2 PWA214	Above Ground Winter Debris Cover 8ft x 12ft	£51.00
L2 PWA215	Above Ground Winter Debris Cover 10ft x 15ft (Exercise)	£72.50
L2 PWA224	Above Ground Winter Debris Cover 12ft x 24ft	£127.00
L2 PWA225	Above Ground Winter Debris Cover 15ft x 21ft (Belgravia)	£155.00
L2 PWA229	Above Ground Winter Debris Cover 16ft x 28ft (Bayswater)	£176.00
L2 PWA230	Above Ground Winter Debris Cover 15ft x 30ft	£175.00
L2 PWA232	Above Ground Winter Debris Cover 16ft x 32ft	£189.00
L2 PWA233	Above Ground Winter Debris Cover 18ft x 33ft (Westminster)	£220.00



### Above Ground WDC Diameter

DISCOUNT CODE/ PRODUCT CODE	DESCRIPTION	PRICE EACH
L2 PWA112	Above Ground Winter Debris Cover 12ft Ø	£75.00
L2 PWA115	Above Ground Winter Debris Cover 15ft Ø (Knightsbridge)	£96.00
L2 PWA116	Above Ground Winter Debris Cover 16ft Ø	£115.00
L2 PWA118	Above Ground Winter Debris Cover 18ft Ø (Mayfair)	£126.00
L2 PWA120	Above Ground Winter Debris Cover 21ft Ø (Kensington)	£161.00
L2 PWA124	Above Ground Winter Debris Cover 24ft Ø	£190.00

### Winch & Cable

DISCOUNT CODE/ PRODUCT CODE	DESCRIPTION	PRICE EACH
K ACW1001	Aluminium Cable Winch	£9.00
K VCCC100	Vinyl Coated Cover Cable 100ft	£31.00

## Plastica Cover Pump

- 25.4mm/FNPT 1" discharge with 3/4" Male Thread
- Mechanical internal float
- A large-base design which assures stability when on the pool cover
- 10-metre power cord
- 6435 LPH
- 3 year warranty



### Plastica Cover Pump

DISCOUNT CODE/ PRODUCT CODE	DESCRIPTION	PRICE EACH
V PCP002	Pool Cover Pump with 10m power cord	£328.00

## Plastica Inflatable Float Pillow

- Designed to fit under winter cover to eradicate water build up on the cover surface

### Plastica Inflatable Float Pillow

DISCOUNT CODE/ PRODUCT CODE	DESCRIPTION	PRICE EACH
L PWA301	0.9m x 1.2m approximate size inflated	£27.95

**Note:** Two pillows are recommended for ovals over 12' x 20'.

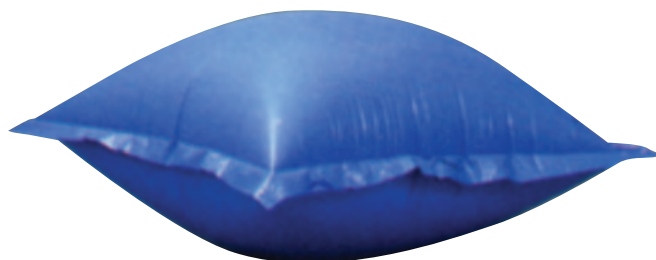

# Pool Maintenance



## Pool Suction Cleaner

- Connects to skimmer or dedicated suction line
- Easy installation
- Quiet operation
- Supplied with 8m of hose (in 10 sections)

### Pool Suction Cleaner

DISCOUNT CODE/ PRODUCT CODE	DESCRIPTION	PRICE EACH
K PAC002	Relax Pool Cleaner	£149.00
K UPC111	Replacement Hose 800mm M/F	£4.40
K UPC112	Replacement Hose 800mm F/F	£4.40

**Note:** Requires a minimum of 0.5hp pump for correct operation.

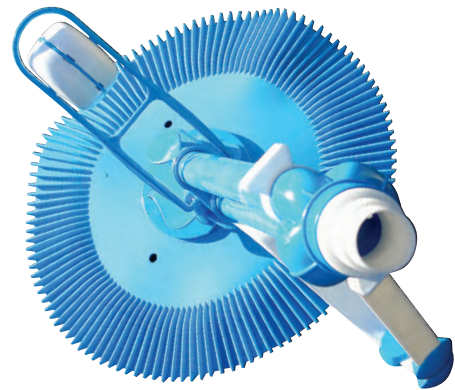

## Kreepy Krauly Sand Shark™

- Programmed steering drive to free itself from tight corners, steps and ladders
- Spring loaded vac port door cover for safety
- Rows of squeegee-like fins dislodge stubborn dirt and debris
- 10m of hose
- 12" cleaning path
- Excellent value for money
- Requires minimum 0.75hp pump

### Sand Shark

DISCOUNT CODE/ PRODUCT CODE	DESCRIPTION	PRICE EACH
H GW7900E	Kreepy Krauly Sand Shark	£528.00

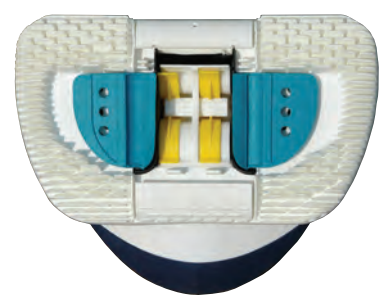

POOL  
MAINTENANCE

# BWT500 Robotic Cleaner

PALLET

## BWT500 Robotic Cleaner

DISCOUNT CODE/ PRODUCT CODE	DESCRIPTION	PRICE EACH
K2 BWTP500	BWT Robotic Cleaner	£1,555.00

- Unmatched suction power
- The finest filtration capacity on the market
- Ideal for any pool
- Fast cleaning
- Safe and reliable
- Simple and practical

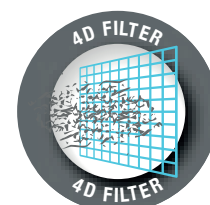
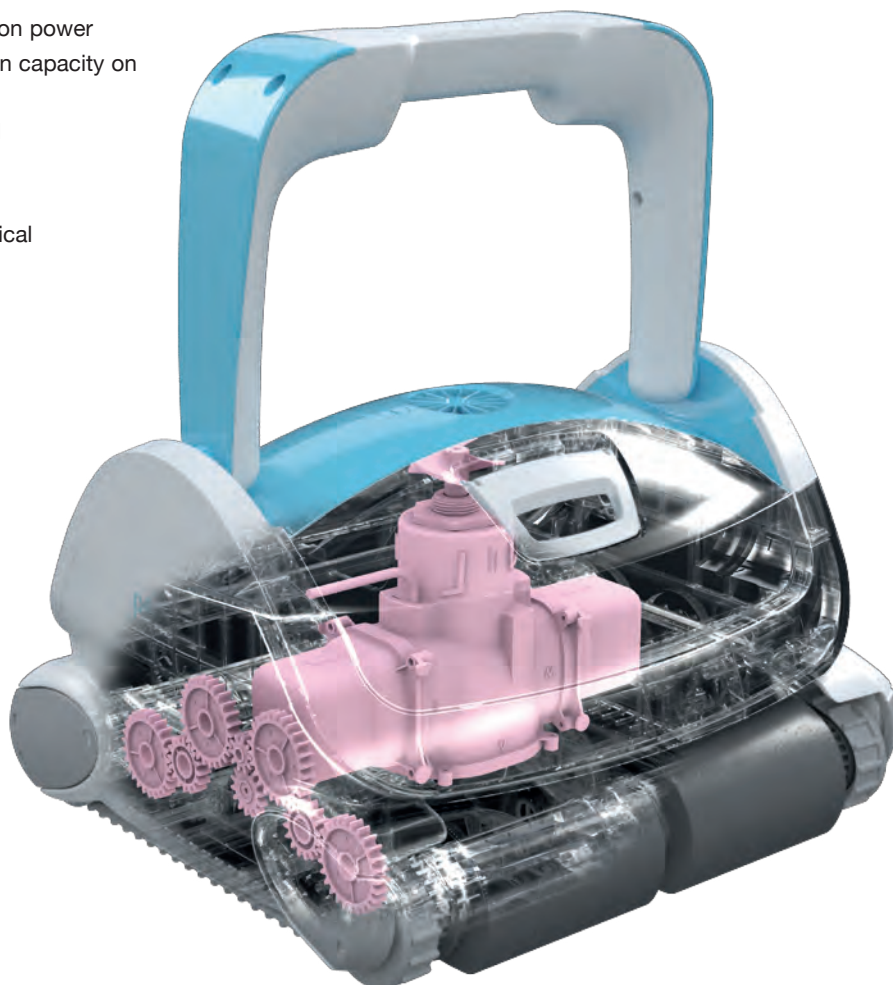

Model	P500
Pool surface area	up to 80 m2
Cleaning cycle duration	2 hours
Cleaning type	Floor, walls & water line
Brush type	PVA Brush + Vibrating brush
Filtration	4D Filter (x2)
Navigation system	Smart Navigation
Filtration Finesse	2 Microns
Drive System	Ultimate Power
Anti-tangle swivel	Yes
Cable length	18m
Adjustable nozzles	Yes
Dimensions (L x W x H)	39.1 x 43 x 23.4 cm
Weight	11kg
Storage accessory	Trolley
Guarantee	3 years

POOL  
MAINTENANCE

## Vacuum Hose

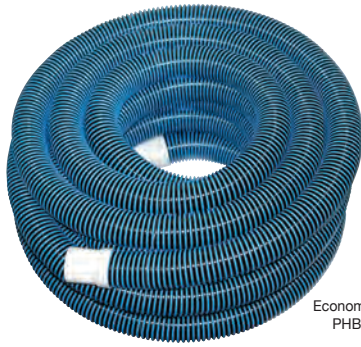

Economy 1.5"  
PHB012



Deluxe 1.5"  
PPM206

### Economy 1.5" (38mm)

DISCOUNT CODE/ PRODUCT CODE	DESCRIPTION	PRICE EACH
H PHB075	7.5m	£33.50
H PHB009	9m	£44.00
H PHB012	12m	£54.00
H PHB015	15m	£64.00

### Deluxe 1.5" (38mm)

DISCOUNT CODE/ PRODUCT CODE	DESCRIPTION	PRICE EACH
M PPM206	6m	£43.80
M PPM209	9m	£49.50
M PPM212	12m	£67.00
M PPM215	15m	£84.00
M PPM218	18m	£108.00

### Economy Bulk

DISCOUNT CODE/ PRODUCT CODE	DESCRIPTION	PRICE EACH
H PHB525	50m 1.25" (32mm) cuffed every 1m	£115.00
H PHB550	50m 1.5" (38mm) cuffed every 1m	£159.00

### Deluxe Bulk

DISCOUNT CODE/ PRODUCT CODE	DESCRIPTION	PRICE EACH
M ZAP341	36m 1.25" (32mm) cuffed every 1.5m	£185.00
M PAM305	36m 1.5" (38mm) cuffed every 1.5m	

\*Colour may vary

## Vacuum Hose Accessories

### Accessories

DISCOUNT CODE/ PRODUCT CODE	DESCRIPTION	PRICE EACH
H PHR001	Reel (holds up to 13m of hose)	£40.00
M PPM302	1.5" Cuff	£4.50
K ZAP370	1.5" Threaded Hosetail / 1.5" or 1.25" Hose	£6.50



Cuff - PPM302



Threaded Hosetail - ZAP370

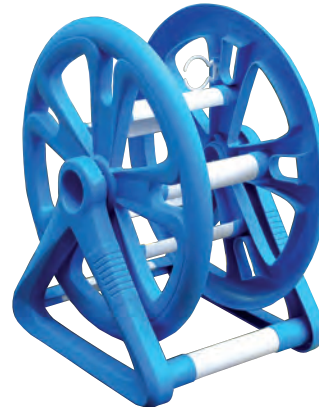

Reel - PHR001

## Inline Leaf Traps

- For use with automatic suction cleaners
- Captures twigs, leaves, stones, hair etc.
- H-RA-211084, ILT100 and ILT102 include 914mm flexible hose

### Inline Leaf Trap

DISCOUNT CODE/ PRODUCT CODE	DESCRIPTION	PRICE EACH
H H-RA-211084	Rainbow	£158.55
K ILT101	Replacement Bag for ILT100	£10.50
K ILT102	Economy with basket	£76.00



Rainbow - H-RA-211084

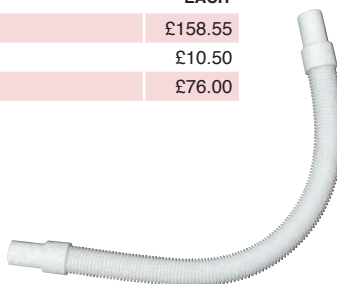

ILT102

## Poles

LONG

- Complock compression locking device
- Made of ribbed anodised aluminium

### Commercial Telescopic

DISCOUNT CODE/ PRODUCT CODE	DESCRIPTION	PRICE EACH
D PTP900	3.6 - 7m	£237.00
D PTP950	4.9 - 9.14m	£258.00

- Made of ribbed anodised aluminium
- Synthetic handle

### Domestic Complock Telescopic

DISCOUNT CODE/ PRODUCT CODE	DESCRIPTION	PRICE EACH
D PTP611	1.8 - 3.3m (11ft)	£67.90
D PTP815	2.4 - 4.6m (15ft)	£81.40

### Eco Telescopic

DISCOUNT CODE/ PRODUCT CODE	DESCRIPTION	PRICE EACH
H ETP001	1.8 - 3.3m	£24.00
H ETP002	2.6 - 4.6m	£33.00

- One piece Lifhook Poles
- Grip handle
- 32mm diameter aluminium

### Pole Hooks

DISCOUNT CODE/ PRODUCT CODE	DESCRIPTION	PRICE EACH
H PPH001	Plastic - Pack of Two	£4.00

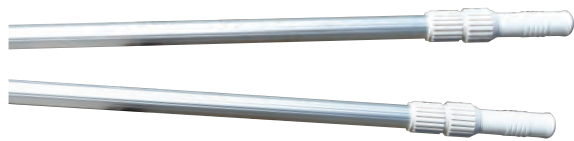

Eco Poles – ETP001 & ETP002



Pole Hooks – PPH001



Plastica  
www.plasticapools.net



POOL  
MAINTENANCE

## Intex Standard Pool Maintenance Kits

- 2.39m Telescopic Pole
- Interchangeable vacuum and skimmer heads
- For use with pools up to 16'
- Utilises standard garden hose



For Intex size spas/pools only

Intex Pool Maintenance Kit			
DISCOUNT CODE/ PRODUCT CODE	DESCRIPTION		PRICE EACH
L 28002/E	Standard		£23.00

## Intex Deluxe Pool Maintenance Kits

- 2.79m Telescopic Pole
- Vacuum sucks debris off pool wall and through filter
- Durable and deep skimmer net
- Attaches to the pool outlet connector with a 7.5m hose
- For use with pools up to 18'
- Requires a pump with minimum flow rate of 800 gallons p/h



For Intex size spas/pools only

Intex Pool Maintenance Kit			
DISCOUNT CODE/ PRODUCT CODE	DESCRIPTION		PRICE EACH
L 28003/E	Deluxe Pool Maintenance Kit		£55.50

## Hand Held Vacuum Kit

- Suitable for all pools and spas
- Easy to configure
- Various attachments
- Wall clip storage

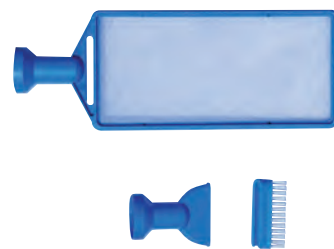

For Intex size spas only

Hand Held Vacuum Kit			
DISCOUNT CODE/ PRODUCT CODE	DESCRIPTION		PRICE EACH
K DSP917	Vacuum Kit		£39.00



POOL  
MAINTENANCE

## Intex Rechargeable Hand Held Vacuum Kit

- Suitable for use with all PureSpas and above ground pools up to 18" diameter
- Strong built-in rechargeable batteries (50 minutes per charge) for powerful suction capability
- 94" (239cm) lightweight telescopic aluminium pole
- Shaft adapter to fit longer/wider telescopic aluminium poles
- Automatic shut-off feature when vacuum is not submerged
- IPX8 waterproof switch
- USB cable included for convenient recharging



### Intex Rechargeable Hand Held Vacuum Kit

DISCOUNT CODE/ PRODUCT CODE	DESCRIPTION	PRICE EACH
K 28620/E	Rechargeable Hand Held Vacuum	£99.50



## Pool Brushes



A



B



C



D



E

### Brushes

DISCOUNT CODE/ PRODUCT CODE	DESCRIPTION	PRICE EACH
M MPM280	Curved Wall Brush 18" (457mm) A	£6.90
M MPM300	Aluminium Backed 18" (457mm) B	£12.90
M MPM302	Aluminium Backed 36" (914mm) C	£44.00
M MPM301	Flexible 18" (457mm) D	£17.00
M MPM325	Algae with Stainless Bristles E	£14.00

## Aqua Fingers® Microfibre Broom Head

Patented Aqua Fingers® makes cleaning fibreglass, tiled and vinyl lined swimming pools easier and quicker as more surface area is covered by its high-density microfibre chenille attachment, flexible body and curved underbelly. This ensures no nooks or crannies are missed.

All it takes is a quick sweep to clean curved corners, ridges, crevices and steps on smooth pool surfaces thanks to a flexible design that manoeuvres around tight spots and awkward areas.

- Made from flexible ethylene-vinyl acetate (EVA), which makes it easier to clean curved corners, ridges, crevices and steps
- Premium Microfibre chenille attachment is gentle on smooth surfaces
- Flexible toggles manoeuvre freely, dislodging particles from tight areas
- Ideal for cleaning fibreglass, tiled and vinyl-lined pools
- Can be used to clean glass pool fences, glass windows and pool covers
- 2 year warranty on broom head only

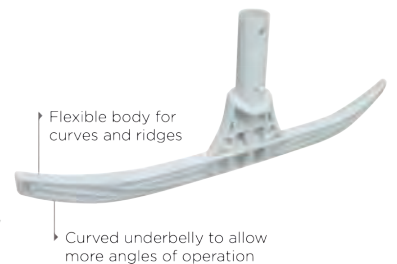

### Aqua Fingers® Microfibre Broom Head

DISCOUNT CODE/ PRODUCT CODE	DESCRIPTION	PRICE EACH
M 313300	Aqua Fingers® complete	£38.85
M 31330012	Aqua Fingers® complete, box of 12	£430.30
M 31331	Aqua Fingers® microfibre cover spare	£26.00

## Concrete & Commercial Vacuum Heads

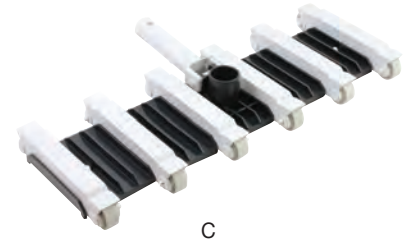
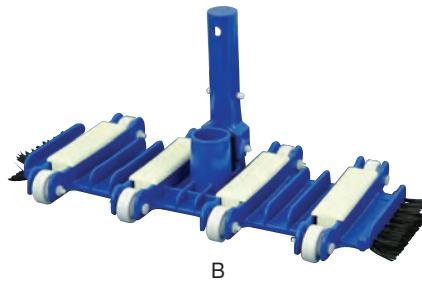
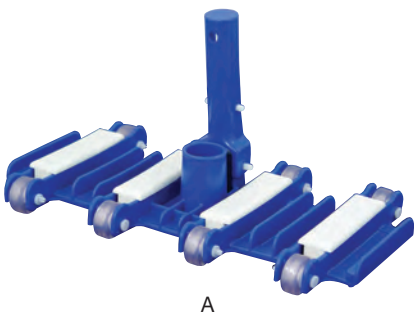

### Concrete

DISCOUNT CODE/ PRODUCT CODE	DESCRIPTION	PRICE EACH
M MPM060	13" Without Side Brushes A	£18.30
M MPM104	13" With Side Brushes B	£25.00

### Commercial

DISCOUNT CODE/ PRODUCT CODE	DESCRIPTION	PRICE EACH
M MPM111	19" Vac Head C	£25.00
K CVH19	19" Deluxe D	£179.14

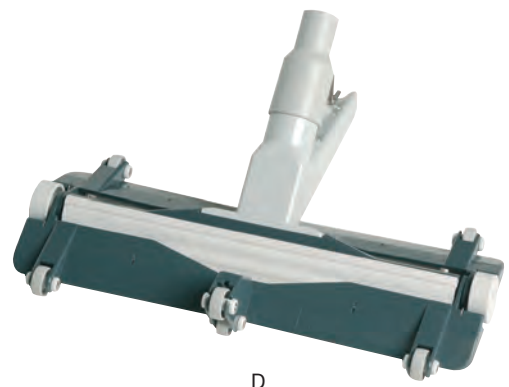

## Liner Vacuum Heads

### Liner

DISCOUNT CODE/ PRODUCT CODE	DESCRIPTION	PRICE EACH
M PVH006	Weighted (A)	£22.80
M MPM100	Triangular (B)	£13.90
M MPM105	Weighted vac head with side brushes (C)	£22.50
S MPM10001	Yoke Assembly (D)	£5.10
M MPM110	Deluxe Vac Head with Air Relief Valve (E)	£14.90



C



A



B

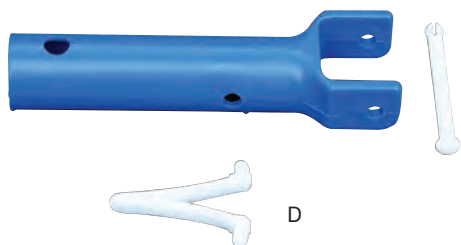

D



E

## Leaf Nets



A



B



C

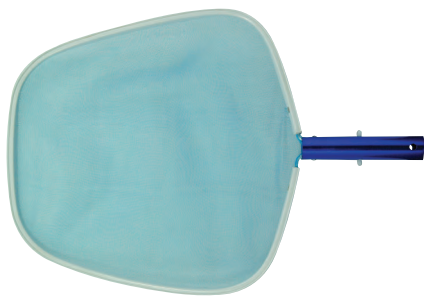

D



E



F

### Leaf Nets

DISCOUNT CODE/ PRODUCT CODE	DESCRIPTION	PRICE EACH
M MPM306	Heavy Duty Leaf Net A	£12.00
M PPM202	Plastica Shallow Leaf Net with Lip B	£15.59
M PPM204	Plastica Deep Leaf Net with Lip C	£22.33
M MPM305	Shallow Leaf Net D	£10.40
M MPM307	Heavy Duty Shallow Leaf Net E	£11.40
M MPM310	Metal Rimmed Deep Leaf Net F	£13.20

POOL  
MAINTENANCE

# Thermometers



Deluxe Floating – BTH900

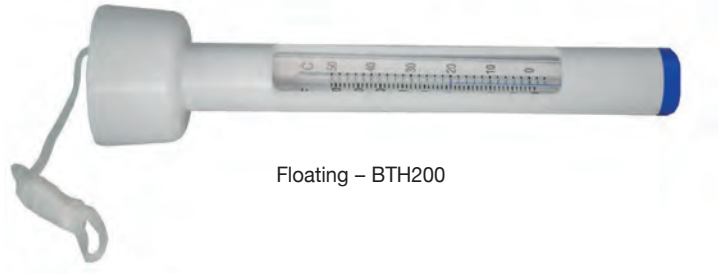

Floating – BTH200



Chrome On Plastic – BTH400

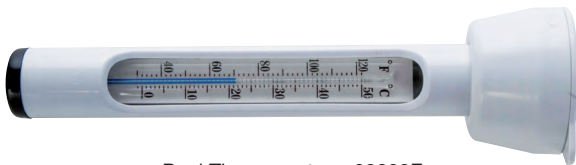

Pool Thermometer – 29039E

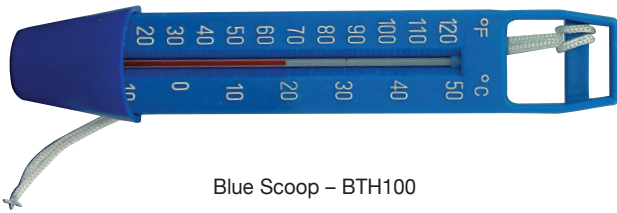

Blue Scoop – BTH100

## Thermometers

DISCOUNT CODE/ PRODUCT CODE	DESCRIPTION	PRICE EACH
M BTH900	Deluxe Floating	£15.50
M 29039/E	Pool Thermometer with string	£3.20
M BTH100	Blue Scoop	£4.50
M BTH200	Floating with string	£7.50
M BTH400	Chrome on Plastic	£6.00

## Novelty Thermometers

DISCOUNT CODE/ PRODUCT CODE	DESCRIPTION	PRICE EACH
M BTH004	Box of 4 Novelty Thermometers	£22.00



Novelty Thermometers – BTH004

# Above Ground





## Premium Wooden Pool Kits



We appreciate that customers require the freedom to specify exactly what they need with their wooden pool. Each pool can be customised to suit the customers needs, making it easier to up-spec to a top of the range piece of equipment that can be enjoyed for years to come.

We have listed what we regard as essential components and optional extras. On top of this, individual product discounts apply, which is great news for our customers. We can still offer wooden pools we have listed in previous years or bespoke wooden pools - just call us for more information.

**For the full range go to [www.woodenpools.net](http://www.woodenpools.net)**

**It is important to read through each option to see what comes with each kit, as most of the equipment has been separated.**

### All our Structure Kits contain the following:



**A robust timber structure** - Using 44mm pressure treated redwood timber, which is selected from renewable sources. Included are all necessary timber supports and fixings, along with an external wooden ladder and internal Stainless Steel ladder.

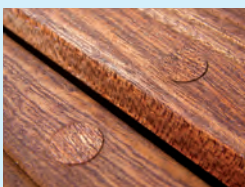

**An exotic two piece hardwood top shelving** - Featuring our own reversible bespoke profile, designed to make fixing as neat as possible using our plug and pellet hidden fixings.



**Metal braces** - For pools that require metal braces these are included in the structure kit. On premium pools, these are cleverly boxed in to keep the wonderful timber aesthetics.



**Wooden Pool Ladder** - All premium wooden structure kits now contain our new removable stainless steel ladder, making tailor made covers simple to use.

**Foam and Felt underlay** - Giving our tailored liners a beautiful soft touch as well as added protection, complete with spray adhesive and underlay tape.



**White goods kit** - Endurance skimmers embody the latest in technological innovation to guarantee reliability and quality.

ABOVE  
GROUND



**Filtration Kit** - Comes with the reliable iFlo 0.75hp pump and filter package, including glass filter media, as well as essential plumbing kit to complete your installation or upgrade by choosing our own British-made **Argonaut Pump** and Filtration package for an even better performance.

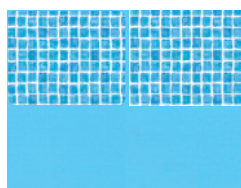

**Liner options** - Our liners are now priced as separate options to give you more choice and make quotations easier. Simply select the style and pattern required and add to your order. See pages 48 & 49 for liner options.



Upgraded Argonaut package comes as standard for our flagship Chelsea Wooden Pool, including essential plumbing with 2 main drains. (Extra fittings available if plant is situated away from pool).



**Maintenance Kit contains** - Backwash hose, chemical starter kit, vac head, vac hose, telescopic pole, leaf net and brush - everything you need to keep your pool beautifully clean.

### Optional extras



**Heating** - If you are looking to heat your wooden pool, we have specified our recommended heating methods for you to choose from.



**Lighting** - With the hugely successful Mini Brio+ Lights we have produced a complete Lighting Package for wooden pools. Available in brilliant white or full remote-control colour-change setup.

**Note:** we strongly recommend equipment we have selected for each wooden pool. If you wish to upgrade please speak to one of our advisors.



## Wooden Pool Filtration Enclosures

- Securely house your pool filtration, heating etc.
- Full height of pool
- Designed to be fitted to skimmer wall
- Double front doors
- Easily removable top for complete access
- Top trap for easy skimmer maintenance

### Wooden Pool Filtration Enclosure

DISCOUNT CODE/ PRODUCT CODE	DESCRIPTION	PRICE EACH
L2 WFE100	Standard Wooden Pool Plant Enclosure	£499.00



Backboard shown for illustration purposes only



**Note: Fits the following pools only:**  
Knightsbridge, Begravia, Bayswater, Westminster, Small Eco, Large Eco and Large Stretch Eco.

## Wooden Pool Pipework Kit



- Pipework Kit for addition of electric heaters or other plant

### Wooden Pool Pipework Kit

DISCOUNT CODE/ PRODUCT CODE	DESCRIPTION	PRICE EACH
L2 WPU200K	Pipework Kit	£164.00

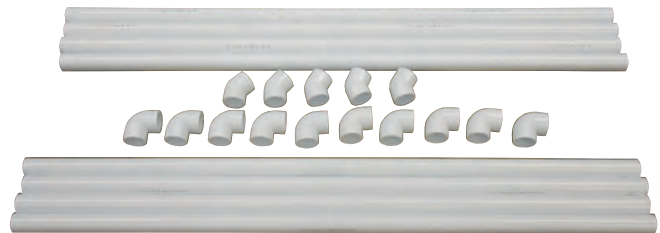

ABOVE  
GROUND

## Wooden Pool Brace Kits



### Braces

DISCOUNT CODE/ PRODUCT CODE	DESCRIPTION	PRICE EACH
L2 WPB012K	Belgravia, contains 2 braces	£530.00
L2 WPB013K	Bayswater, contains 4 braces	£1,060.00
L2 WPB013K	Large Stretched Eco, contains 4 braces	£1,060.00
L2 WPB014K	Westminster, contains 6 braces	£1,590.00
L2 WPB016K	Chelsea, contains 12 braces	£3,180.00
L2 WPB013K	Nazca 4 x 2m 4 braces	£1,060.00
L2 WPB015K	Nazca 8 x 2m 8 braces	£2,120.00
L2 WPB016K	Nazca 8 x 4m 12 braces	£3,180.00



# The Nazca Wooden Pool Range

10YR  
PRO-RATA  
WARRANTY

HEAVY  
ITEM

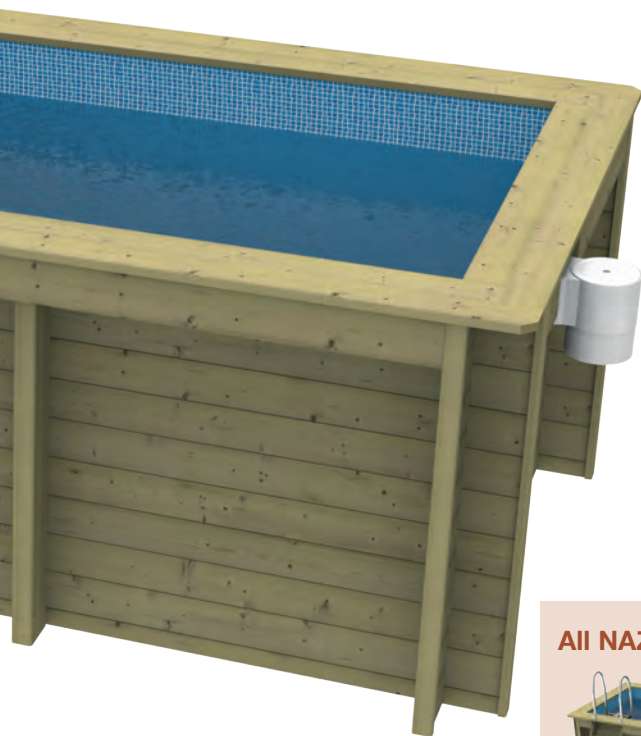

Our new rectangular wooden pools are built to make the most of your outdoor space and give you a quick build time while also offering an affordable option to enjoy your very own pool.

All models are designed to be compact with a neat finish to your pool set up.

**For the full range go to [www.woodenpools.net](http://www.woodenpools.net)**

**It is important to read through each option to see what comes with each kit, as most of the equipment has been separated.**

Our Nazca range comes in 3 sizes:

- 4m x 2m Nazca Pool - the ideal exercise or fun pool
- 8m x 2m Nazca Pool - the lap pool
- 8m x 4m Nazca Pool - the all round family pool

## All NAZCA pools come with Structure Kits which contain the following:

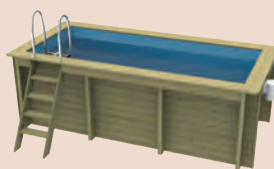

**A robust timber structure** - Using 44mm pressure treated redwood timber, which is all selected from renewable sources. Included are all necessary timber supports and fixings, along with an external wooden ladder and internal Stainless Steel ladder.



**Metal braces** - All pools that require metal braces are included in the structure kit. These are cleverly boxed in to keep the wonderful timber aesthetics.



**Wooden Pool Ladder** - All Nazca wooden structure kits now contain our new removable stainless steel ladder, making tailor made covers simple to use.



**Foam and Felt underlay** - Giving our tailored liners a beautiful soft touch as well as added protection, complete with spray adhesive and underlay tape.



**White Goods Kit** - Endurance skimmers embody the latest in technological innovation to guarantee reliability and quality.

**Just add your choice of Pool Liner from our range!**

INDIVIDUAL  
DISCOUNTS APPLY  
FOR PACKAGES

**Plain Liner** Choose from our Plain Liner range of Sand, White, Green, Grey, Light Blue & Adriatic Blue. (Other patterned options available upon request)

## Plain Liner Materials

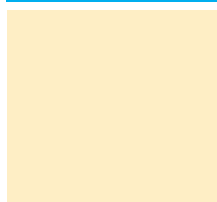

Sand

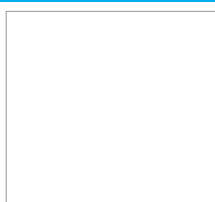

White

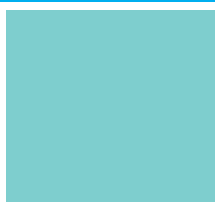

Green

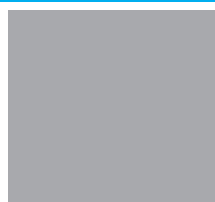

Grey

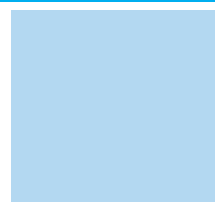

Light Blue

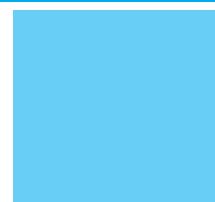

Adriatic Blue ★★

★★ Also available in 0.5mm (20thou)

ABOVE  
GROUND

# 4m x 2m Nazca Wooden Pool

10YR  
PRO-RATA  
WARRANTY\*

HEAVY  
ITEM



INDIVIDUAL  
DISCOUNTS APPLY  
FOR PACKAGES



The Nazca 4m x 2m Wooden Pool is developed from our exercise pool, making this model ideal for conversion with the addition of a Counter Current system.

Model	External size	Internal size	Wall height	Water level height *	Water Volume
4m x 2m	4.5m x 2.5m	4m x 2m	1.35m	1.22m	9,720L

## Complete Pool Kit

Contains: Structure Kit, iFlo Filtration Kit with glass filter media, Plain Liner option and Maintenance Kit

Pool Dimensions available on page 184

### 4m x 2m Nazca Wooden Structure Kit

DISCOUNT CODE/ PRODUCT CODE	DESCRIPTION	PRICE EACH
L3 NWP042SK	Wooden Structure Kit contains 4 braces	£5,675.00

### Filtration Kit\*

DISCOUNT CODE/ PRODUCT CODE	DESCRIPTION	PRICE EACH
L2 WFK001	iFlo Filter Pump Pack c/w Essential Plumbing* inc. glass filter media	£540.00
L2 WPU200K	Wooden Pool Extra Pipework Kit	£164.00
L2 WFK001U	Upgraded Argonaut and Premium Filter Pack c/w Essential Plumbing inc. glass filter media	£1,155.00

### Liner Options\*

DISCOUNT CODE/ PRODUCT CODE	DESCRIPTION	PRICE EACH
A PLI442	30thou Plain Liner (24m <sup>2</sup> )	£877.20
A PLI4420	30thou Plain Liner with Tileband (24m <sup>2</sup> )	£1,017.60
A PLI4421	30thou Patterned Liner (24m <sup>2</sup> )	£1,221.60

### Maintenance Kit\*

DISCOUNT CODE/ PRODUCT CODE	DESCRIPTION	PRICE EACH
M WMK001	Maintenance Pack & Starter Kit*	£167.50

### Light Package Options\*

DISCOUNT CODE/ PRODUCT CODE	DESCRIPTION	PRICE EACH
K2 MCLED01K	Mini Brio + White LED Kit contains 1 white light c/w 100W Transformer & Deck Box Kit	£335.00
K2 MCRGB01K	Mini Brio + RGB LED Kit c/w Remote contains 1 RGBW light c/w sync panel 100W Transformer & Deck Box Kit	£530.00

### Heating Options\*

DISCOUNT CODE/ PRODUCT CODE	DESCRIPTION	PRICE EACH
H2 HSI078	HeatSeeker 7.8kW Inverter Heat Pump	£1,428.00

\* Plastica give a 10 year parts only warranty to the timber structure. Terms & Conditions apply.

ABOVE  
GROUND

# 8m x 2m Nazca Wooden Lap Pool

10YR  
PRO-RATA  
WARRANTY

HEAVY  
ITEM



INDIVIDUAL  
DISCOUNTS APPLY  
FOR PACKAGES

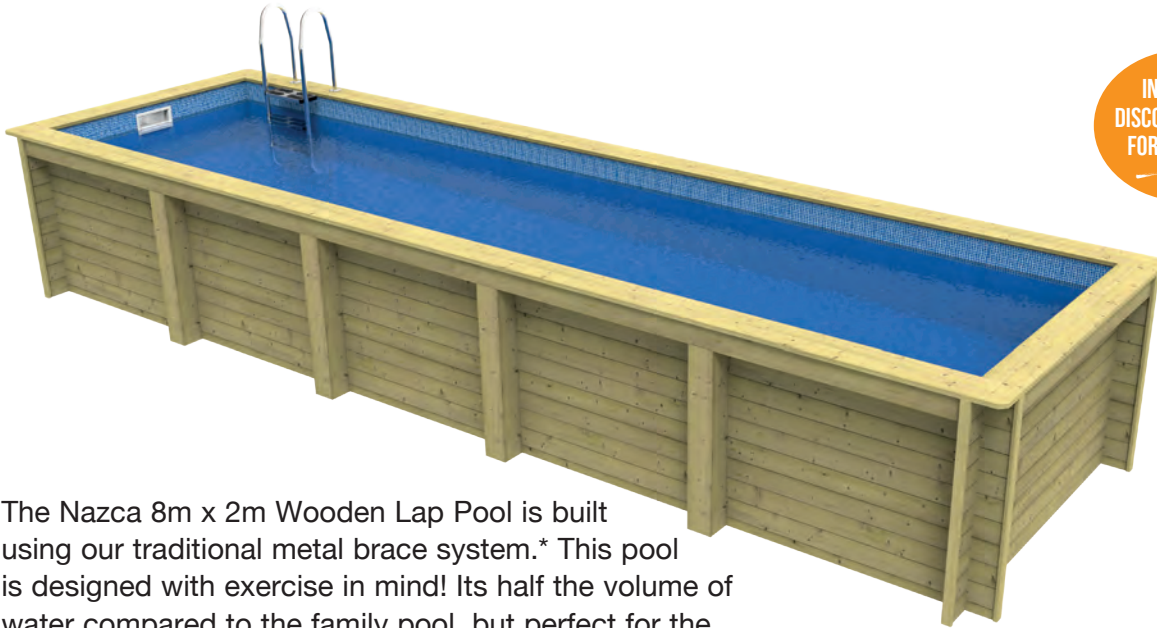

The Nazca 8m x 2m Wooden Lap Pool is built using our traditional metal brace system.\* This pool is designed with exercise in mind! Its half the volume of water compared to the family pool, but perfect for the professional swimmer.

Model	External size	Internal size	Wall height	Water level height *	Water Volume
8m x 2m	8.5m x 2.5m	8m x 2m	1.35m	1.22m	19,440L

\*The water level should be halfway between the height of the skimmer or 135mm lower than the wall height.

## Complete Pool Kit

Contains: Structure Kit, iFlo Filtration Kit with glass filter media, Plain Liner option and Maintenance Kit

Pool Dimensions available on page 184

### 8m x 2m Nazca Wooden Lap Pool Structure Kit

DISCOUNT CODE/ PRODUCT CODE	DESCRIPTION	PRICE EACH
L3 NWP082SK	Wooden Structure Kit contains 8 metal braces	£8,800.00

### Filtration Kit\*\*

DISCOUNT CODE/ PRODUCT CODE	DESCRIPTION	PRICE EACH
L2 WFK001	iFlo Filter Pump Pack c/w Essential Plumbing* inc. glass filter media	£540.00
L2 WPU200K	Wooden Pool Extra Pipework Kit	£164.00
L2 WFK001U	Upgraded Argonaut and Premium Filter Pack c/w Essential Plumbing inc. glass filter media	£1,155.00

### Liner Options\*\*

DISCOUNT CODE/ PRODUCT CODE	DESCRIPTION	PRICE EACH
A PLI842	30Thou Plain Liner (43m <sup>2</sup> )	£1,571.65
A PLI8420	30Thou Plain Liner with Tileband (43m <sup>2</sup> )	£1,823.20
A PLI8421	30Thou All-over Patterned Liner (43m <sup>2</sup> )	£2,188.70

### Maintenance Kit\*\*

DISCOUNT CODE/ PRODUCT CODE	DESCRIPTION	PRICE EACH
M WMK001	Maintenance Pack & Starter Kit*	£167.50

### Light Package Options\*\*

DISCOUNT CODE/ PRODUCT CODE	DESCRIPTION	PRICE EACH
K2 MCLED03K	Mini Brio + White LED Kit contains 3 white light c/w 100W Transformer & 3 Deck Box Kits	£770.00
K2 MCRGB03K	Mini Brio + RGB LED Kit c/w Remote contains 3 RGBW light c/w sync panel 100W Transformer & 3 Deck Box Kits	£1,125.00

### Heating Options\*\*

DISCOUNT CODE/ PRODUCT CODE	DESCRIPTION	PRICE EACH
H2 HSI078	HeatSeeker 7.8kW Inverter Heat Pump	£1,428.00

\* Plastica give a 10 year parts only warranty to the timber structure. Terms & Conditions apply.

# 8m x 4m Nazca Wooden Pool

10YR  
PRO-RATA  
WARRANTY\*

HEAVY  
ITEM

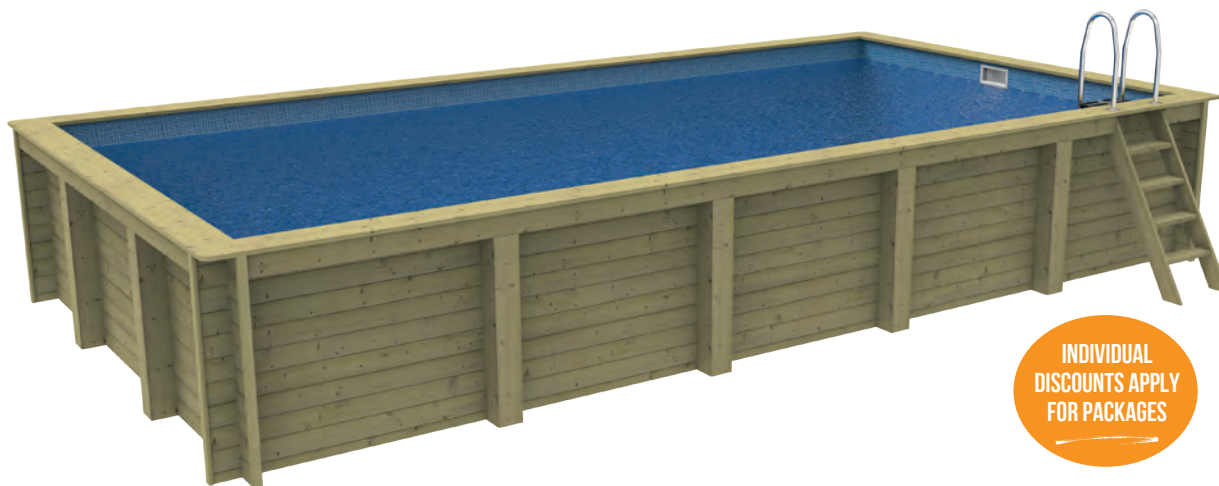

INDIVIDUAL  
DISCOUNTS APPLY  
FOR PACKAGES

The Nazca 8m x 4m Wooden Pool is built using our traditional metal brace system.\* This pool is an ideal all round pool, a good size for family fun and swimming!

Model	External size	Internal size	Wall height	Water level height *	Water Volume
8m x 4m	8.5m x 4.5m	8m x 4m	1.35m	1.22m	38,880L

\*The water level should be halfway between the height of the skimmer or 135mm lower than the wall height.

## Complete Pool Kit

Contains: Structure Kit, iFlo Filtration Kit with glass filter media, Plain Liner option and Maintenance Kit

Pool Dimensions available on page 184

### 8m x 4m Nazca Wooden Structure Kit

DISCOUNT CODE/ PRODUCT CODE	DESCRIPTION	PRICE EACH
L3 NWP084SK	Wooden Structure Kit contains 12 metal braces	£10,625.00

### Filtration Kit\*\*

DISCOUNT CODE/ PRODUCT CODE	DESCRIPTION	PRICE EACH
L2 WFK001	iFlo Filter Pump Pack c/w Essential Plumbing* inc. glass filter media	£540.00
L2 WPU200K	Wooden Pool Extra Pipework Kit	£164.00
L2 WFK001U	Upgraded Argonaut and Premium Filter Pack c/w Essential Plumbing inc. glass filter media	£1,155.00

### Liner Options\*\*

DISCOUNT CODE/ PRODUCT CODE	DESCRIPTION	PRICE EACH
A PLI844	30Thou Plain Liner (64m <sup>2</sup> )	£2,339.20
A PLI8440	30Thou Plain Liner with Tileband (64m <sup>2</sup> )	£2,713.60
A PLI8441	30Thou All-over Patterned Liner (64m <sup>2</sup> )	£3,257.60

### Maintenance Kit\*\*

DISCOUNT CODE/ PRODUCT CODE	DESCRIPTION	PRICE EACH
M WMK001	Maintenance Pack & Starter Kit*	£167.50

### Light Package Options\*\*

DISCOUNT CODE/ PRODUCT CODE	DESCRIPTION	PRICE EACH
K2 MCLED03K	Mini Brio + White LED Kit contains 3 white light c/w 100W Transformer & 3 Deck Box Kits	£770.00
K2 MCRGB03K	Mini Brio + RGB LED Kit c/w Remote contains 3 RGBW light c/w sync panel 100W Transformer & 3 Deck Box Kits	£1,125.00

### Heating Options\*\*

DISCOUNT CODE/ PRODUCT CODE	DESCRIPTION	PRICE EACH
H2 HSI125	HeatSeeker 12.5kW Inverter Heat Pump	£1,956.00

\* Plastica give a 10 year parts only warranty to the timber structure. Terms & Conditions apply.

ABOVE  
GROUND

# Knightsbridge

10 YR  
PRO-RATA  
WARRANTY\*

HEAVY  
ITEM



Volume 11500 litres  
2500 galls



INDIVIDUAL  
DISCOUNTS APPLY  
FOR PACKAGES

The Knightsbridge Wooden Pool is a compact 4m, internally, octagonal structure with all the high-end quality filtration equipment usually associated with in-ground swimming pools.

## Complete Pool Kit\*

See our channel for our 5-part Premium Wooden Pool video installation

Contains Structure Kit, iFlo Filtration Kit, Plain Liner option and Maintenance Kit

Pool Dimensions available on page 184

### Knightsbridge\*

DISCOUNT CODE/ PRODUCT CODE	DESCRIPTION	
L2 WSK001	Structure Kit* includes all goods shown in blue section on page 166	£5,350.00

### Filtration Kit\*

DISCOUNT CODE/ PRODUCT CODE	DESCRIPTION	
L2 WFK001	iFlo Filter Pump Pack c/w Essential Plumbing* inc. glass filter media	£540.00
L2 WPU200K	Wooden Pool Extra Pipework Kit	£164.00
L2 WFK001U	Upgraded Argonaut and Premium Filter Pack c/w Essential Plumbing* inc. glass filter media	£1,155.00

### Liner Options\*

DISCOUNT CODE/ PRODUCT CODE	DESCRIPTION	
A PLI4011	30Thou Plain Liner 0.75mm* (31m <sup>2</sup> )	£1,133.05
A PLI401	30Thou Plain Liner with Tileband 0.75mm (31m <sup>2</sup> )	£1,314.40
A PLI4012	30Thou All-over patterned Liner 0.75mm (31m <sup>2</sup> )	£1,577.90

### Maintenance Kit\*

DISCOUNT CODE/ PRODUCT CODE	DESCRIPTION	
M WMK001	Maintenance Pack & Starter Kit*	£167.50

### Light Package Options\*

DISCOUNT CODE/ PRODUCT CODE	DESCRIPTION	
K2 MCLED01K	Mini Brio + White LED Kit contains 1 white light c/w 100W Transformer & Deck Box Kit	£335.00
K2 MCRGB01K	Mini Brio + RGB LED Kit c/w Remote contains 1 RGBW light c/w sync panel 100W Transformer & Deck Box Kit	£530.00

### Heating Options\*

DISCOUNT CODE/ PRODUCT CODE	DESCRIPTION	
H2 HSI078	HeatSeeker 7.8kW Inverter Heat Pump	£1,428.00
H E2-1-6	Electro Evolution Electric Heater 6kW	£637.57

### Filtration Enclosure

DISCOUNT CODE/ PRODUCT CODE	DESCRIPTION	
L2 WFE100	Standard Wooden Pool Plant Enclosure	£499.00

\* Plastica give a 10 year parts only warranty to the timber structure. Terms & Conditions apply.

# Belgravia

10 YR  
PRO-RATA  
WARRANTY

HEAVY  
ITEM



Volume 21000 litres  
4600 galls



INDIVIDUAL  
DISCOUNTS APPLY  
FOR PACKAGES

The Belgravia Wooden Pool is a 3.694m x 5.564m, internally, stretched octagonal structure, perfect for all sizes of garden and great for the more serious swimmer.

## Complete Pool Kit\*

See our  channel for our 5-part Premium Wooden Pool video installation

Contains Structure Kit, iFlo Filtration Kit, Plain Liner option and Maintenance Kit

Pool Dimensions available on page 184

### Belgravia with Braces Kit\*

DISCOUNT CODE/ PRODUCT CODE	DESCRIPTION	
L2 WSK003	Structure Kit including Brace Kit, contains 2 braces*	£7,395.00

### Filtration Kit\*

DISCOUNT CODE/ PRODUCT CODE	DESCRIPTION	
L2 WFK001	iFlo Filter Pump Pack c/w Essential Plumbing* inc. glass filter media	£540.00
L2 WPU200K	Wooden Pool Extra Pipework Kit	£164.00
L2 WFK001U	Upgraded Argonaut and Premium Filter Pack c/w Essential Plumbing inc. glass filter media	£1,155.00

### Liner Options\*

DISCOUNT CODE/ PRODUCT CODE	DESCRIPTION	
A PLI4041	30Thou Plain Liner 0.75mm* (44m <sup>2</sup> )	£1,608.20
A PLI404	30Thou Plain Liner with Tileband 0.75mm (44m <sup>2</sup> )	£1,865.60
A PLI4042	30Thou All-over Patterned Liner 0.75mm (44m <sup>2</sup> )	£2,239.60

### Maintenance Kit\*

DISCOUNT CODE/ PRODUCT CODE	DESCRIPTION	
M WMK001	Maintenance Pack & Starter Kit*	£167.50

### Light Package Options\*

DISCOUNT CODE/ PRODUCT CODE	DESCRIPTION	
K2 MCLED01K	Mini Brio + White LED Kit contains 1 white light c/w 100W Transformer & Deck Box Kit	£335.00
K2 MCRGB01K	Mini Brio + RGB LED Kit c/w Remote contains 1 RGBW light c/w sync panel 100W Transformer & Deck Box Kit	£530.00

### Heating Options\*

DISCOUNT CODE/ PRODUCT CODE	DESCRIPTION	
H2 HSI078	HeatSeeker 7.8kW Inverter Heat Pump	£1,428.00
H E2-1-9	Elecro Evolution Electric Heater 9kW	£687.01

### Filtration Enclosure

DISCOUNT CODE/ PRODUCT CODE	DESCRIPTION	
L2 WFE100	Standard Wooden Pool Plant Enclosure	£499.00

\* Plastica give a 10 year parts only warranty to the timber structure. Terms & Conditions apply.

ABOVE  
GROUND

# Bayswater

10YR  
PRO-RATA  
WARRANTY\*

HEAVY  
ITEM



Volume 25000 litres  
5500 galls



INDIVIDUAL  
DISCOUNTS APPLY  
FOR PACKAGES

The Bayswater Wooden Pool is a 3.694m x 6.564m, internally, stretched octagonal structure. It is the bigger brother of the Belgravia but with an extra 1m length making an incredible difference.

## Complete Pool Kit\*

See our channel for our 5-part Premium Wooden Pool video installation

Contains Structure Kit, iFlo Filtration Kit, Plain Liner option and Maintenance Kit

Pool Dimensions available on page 184

### Bayswater with Braces Kit\*

DISCOUNT CODE/ PRODUCT CODE	DESCRIPTION	
L2 WSK004	Structure Kit including Brace Kit, contains 4 braces*	£8,675.00

### Filtration Kit\*

DISCOUNT CODE/ PRODUCT CODE	DESCRIPTION	
L2 WFK001	iFlo Filter Pump Pack c/w Essential Plumbing* inc. glass filter media	£540.00
C WPU200K	Wooden Pool Extra Pipework Kit	
L2 WFK001U	Upgraded Argonaut and Premium Filter Pack c/w Essential Plumbing inc. glass filter media	£1,155.00

### Liner Options\*

DISCOUNT CODE/ PRODUCT CODE	DESCRIPTION	
A PLI4051	30Thou Plain Liner 0.75mm* (51m <sup>2</sup> )	£1,864.05
A PLI405	30Thou Plain Liner with Tileband 0.75mm (51m <sup>2</sup> )	£2,162.40
A PLI4052	30Thou All-over Patterned Liner 0.75mm (51m <sup>2</sup> )	£2,595.90

### Maintenance Kit\*

DISCOUNT CODE/ PRODUCT CODE	DESCRIPTION	
M WMK001	Maintenance Pack & Starter Kit*	£167.50

### Light Package Options\*

DISCOUNT CODE/ PRODUCT CODE	DESCRIPTION	
K2 MCLED02K	Mini Brio + White LED Kit contains 2 white light c/w 100W Transformer & Deck Box Kit	£550.00
K2 MCRGB02K	Mini Brio + RGB LED Kit c/w Remote contains 2 RGBW light c/w sync panel 100W Transformer & Deck Box Kit	£825.00

### Heating Options\*

DISCOUNT CODE/ PRODUCT CODE	DESCRIPTION	
H2 HSI125	HeatSeeker 12.5kW Inverter Heat Pump	£1,956.00
H E2-1-12	Electro Evolution Electric Heater 12kW	£709.67

### Filtration Enclosure

DISCOUNT CODE/ PRODUCT CODE	DESCRIPTION	
L2 WFE100	Standard Wooden Pool Plant Enclosure	£499.00

\* Plastica give a 10 year parts only warranty to the timber structure. Terms & Conditions apply.

# Westminster

10YR  
PRO-RATA  
WARRANTY\*

HEAVY  
ITEM



Volume 39200 litres  
8600 galls

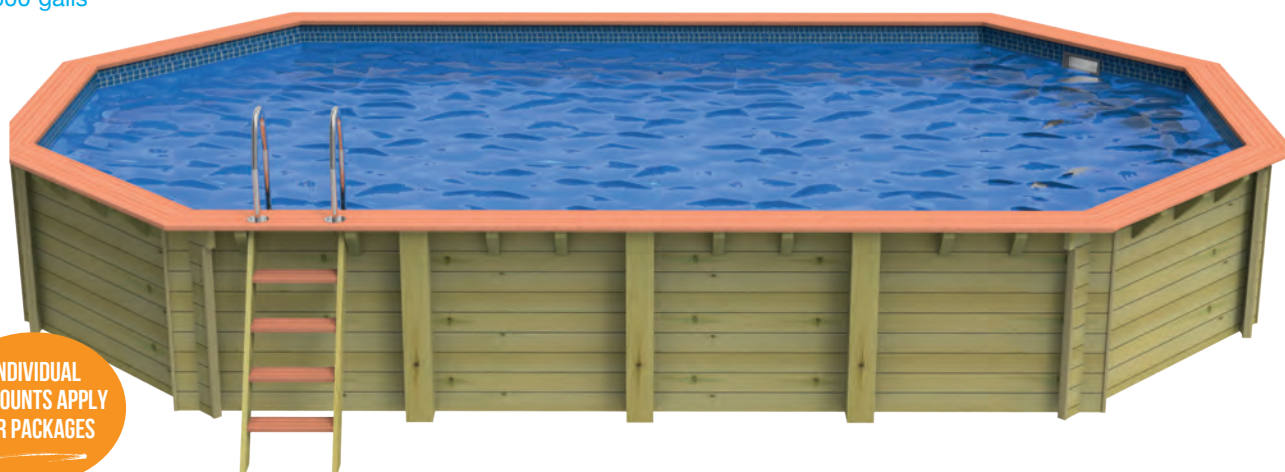

INDIVIDUAL  
DISCOUNTS APPLY  
FOR PACKAGES

The Westminster Wooden Pool is a huge 4.611m x 8.201m, internally, stretched octagonal structure. Designed for the larger garden. Perfect for the larger family as well as keen swimmers.

## Complete Pool Kit\*

See our  channel for our 5-part Premium Wooden Pool video installation

Contains Structure Kit, iFlo Filtration Kit, Plain Liner option and Maintenance Kit

Pool Dimensions available on page 184

### Westminster with Braces Kit\*

DISCOUNT CODE/ PRODUCT CODE	DESCRIPTION	
L2 WSK005	Structure Kit contains 6 braces*	£10,450.00

### Filtration Kit\*

DISCOUNT CODE/ PRODUCT CODE	DESCRIPTION	
L2 WFK001	iFlo Filter Pump Pack c/w Essential Plumbing* inc. glass filter media	£540.00
C WPU200K	Wooden Pool Extra Pipework Kit	
L2 WFK001U	Upgraded Argonaut and Premium Filter Pack c/w Essential Plumbing inc. glass filter media	£1,155.00

### Liner Options\*

DISCOUNT CODE/ PRODUCT CODE	DESCRIPTION	
A PLI4171	30Thou Plain Liner 0.75mm* (71m <sup>2</sup> )	£2,595.05
A PLI417	30Thou Plain Liner with Tileband 0.75mm (71m <sup>2</sup> )	£3,010.40
A PLI4172	All-over Patterned Liner 0.75mm (71m <sup>2</sup> )	£3,613.90

### Maintenance Kit\*

DISCOUNT CODE/ PRODUCT CODE	DESCRIPTION	
M WMK001	Maintenance Pack & Starter Kit*	£167.50

### Light Package Options\*

DISCOUNT CODE/ PRODUCT CODE	DESCRIPTION	
K2 MCLED02K	Mini Brio + White LED Kit contains 2 white light c/w 100W Transformer & Deck Box Kit	£550.00
K2 MCRGB02K	Mini Brio + RGB LED Kit c/w Remote contains 2 RGBW light c/w sync panel 100W Transformer & Deck Box Kit	£825.00

### Heating Options\*

DISCOUNT CODE/ PRODUCT CODE	DESCRIPTION	
H2 HSI125	HeatSeeker 12.5kW Inverter Heat Pump	£1,956.00
H E2-1-18	Electro Evolution Electric Heater 18kW	£882.71

### Filtration Enclosure

DISCOUNT CODE/ PRODUCT CODE	DESCRIPTION	
L2 WFE100	Standard Wooden Pool Plant Enclosure	£499.00

\* Plastica give a 10 year parts only warranty to the timber structure. Terms & Conditions apply.

ABOVE  
GROUND

# Chelsea

10YR  
PRO-RATA  
WARRANTY\*

HEAVY  
ITEM



Volume 57400 litres  
12600 galls



INDIVIDUAL  
DISCOUNTS APPLY  
FOR PACKAGES

The Chelsea Pool is a 5m x 10m, internally, rectangular pool, our largest wooden swimming pool and the flagship of our Premium range. Great above ground or submerged.

## Complete Pool Kit\*

See our  channel for our 5-part Premium Wooden Pool video installation

Contains Structure Kit, Argonaut Filtration Kit, Plain Liner option and Maintenance Kit

Pool Dimensions available on page 184

### Chelsea with Braces Kit\*

DISCOUNT CODE/ PRODUCT CODE	DESCRIPTION	PRICE EACH
L2 WSK006	Structure Kit* includes all goods shown in blue section on page 164	£14,195.00

### Filtration Kit\*

DISCOUNT CODE/ PRODUCT CODE	DESCRIPTION	PRICE EACH
L2 WFK002	1hp Argonaut Pump & 24' Filter pack c/w essential plumbing including two main drains, inc. glass filter media	£1,495.00
L2 WPU200K	Wooden Pool Extra Pipework Kit	£164.00

### Liner Options\*

DISCOUNT CODE/ PRODUCT CODE	DESCRIPTION	PRICE EACH
A PLI1101	30Thou Plain Liner 0.75mm* (89m <sup>2</sup> )	£3,252.95
A PLI110	30Thou Plain Liner with Tileband 0.75mm (89m <sup>2</sup> )	£3,773.60
A PLI1102	30Thou All-over Patterned Liner 0.75mm (89m <sup>2</sup> )	£4,530.10

### Maintenance Kit\*

DISCOUNT CODE/ PRODUCT CODE	DESCRIPTION	PRICE EACH
M WMK002	Maintenance Pack & Starter Kit*	£242.00

### Light Package Options\*

DISCOUNT CODE/ PRODUCT CODE	DESCRIPTION	PRICE EACH
K2 MCLED03K	Mini Brio + White LED Kit contains 3 white light c/w 100W Transformer & 3 Deck Box Kit	£770.00
K2 MCRGB03K	Mini Brio + RGB LED Kit c/w Remote contains 3 RGBW light c/w sync panel 100W Transformer & 3 Deck Box Kit	£1,125.00

### Heating Options\*

DISCOUNT CODE/ PRODUCT CODE	DESCRIPTION	PRICE EACH
H2 HSI170	HeatSeeker 17kW Inverter Heat Pump	£3,073.00

\* Plastica give a 10 year parts only warranty to the timber structure. Terms & Conditions apply.

# Exercise Pool

10YR  
PRO-RATA  
WARRANTY\*

HEAVY  
ITEM



Volume 8150 litres 1795 galls



## STRAP SYSTEM

- With the strap system no steel braces are required, so you can start building immediately
- You are guaranteed to save time and money with a simple and quick build time
- The Exercise Pools can be fitted directly to a level hard surface
- The straps are stainless steel for long-lasting durability, ensuring anti-corrosion

INDIVIDUAL  
DISCOUNTS APPLY  
FOR PACKAGES

The Exercise Pool is a 2.426m x 3.916m, internally, and comes with a choice of three over the wall Counter Current Systems to accommodate most users.

## Complete Pool Kit\* with Badu Perla 1.6kW Counter Current System\*

Contains Structure Kit, iFlo Filtration Kit, Plain Liner option, Maintenance Kit and Badu Perla Counter Current System

See our  channel for our 5-part Premium Wooden Pool video installation

Pool Dimensions available on page 184

### Exercise Pool\*

DISCOUNT CODE/ PRODUCT CODE	DESCRIPTION	PRICE EACH
L2 WSK007	Structure Kit with Brace Kit, contains stainless steel strap system*	£6,195.00
K BAD010	Stella Single phase 3kw White LED Counter Current System	£3,525.00
K BAD012	Stella Single phase 3kw RGB LED Counter Current System	£3,695.00
K AQ100	Aquajet 100 1.1kW Counter Current System - No Longer Available	NLA
K BAD015	Badu Perla 1.6kW Counter Current System	£2,455.00
K BAD006	Badu Riva 2.2kW Counter Current System	£3,084.00

### Filtration Kit\*

DISCOUNT CODE/ PRODUCT CODE	DESCRIPTION	PRICE EACH
L2 WFK001	iFlo Filter Pump Pack c/w Essential Plumbing* inc. glass filter media	£540.00
L2 WPU200K	Wooden Pool Extra Pipework Kit	£164.00
L2 WFK001U	Upgraded Argonaut and Premium Filter Pack c/w Essential Plumbing inc. glass filter media	£1,155.00

### Liner Options\*

DISCOUNT CODE/ PRODUCT CODE	DESCRIPTION	PRICE EACH
A PLI4181	30Thou Plain Liner 0.75mm* (24m <sup>2</sup> )	£877.20
A PLI418	30Thou Plain Liner with Tileband 0.75mm (24m <sup>2</sup> )	£1,017.60
A PLI4182	30Thou All-over Patterned Liner 0.75mm (24m <sup>2</sup> )	£1,221.60

### Maintenance Kit\*

DISCOUNT CODE/ PRODUCT CODE	DESCRIPTION	PRICE EACH
M WMK001	Maintenance Pack & Starter Kit*	£167.50

### Light Package Options\*

DISCOUNT CODE/ PRODUCT CODE	DESCRIPTION	PRICE EACH
K2 MCLED01K	Mini Brio + White LED Kit contains 1 white light c/w 100W Transformer & Deck Box Kit	£335.00
K2 MCRGB01K	Mini Brio + RGB LED Kit c/w Remote contains 1 RGBW light c/w sync panel 100W Transformer & Deck Box Kit	£530.00

### Heating Options\*

DISCOUNT CODE/ PRODUCT CODE	DESCRIPTION	PRICE EACH
H2 HSI078	HeatSeeker 7.8kW Inverter Heat Pump	£1,428.00
H E2-1-6	Electro Evolution Electric Heater 6kW	£637.57

\* Plastica give a 10 year parts only warranty to the timber structure. Terms & Conditions apply.

ABOVE  
GROUND

# X-Stream Exercise Pool

10YR  
PRO-RATA  
WARRANTY\*

HEAVY  
ITEM



Volume 8150 litres 1795 galls



INDIVIDUAL  
DISCOUNTS APPLY  
FOR PACKAGES

## STRAP SYSTEM

- With the strap system no steel braces are required, so you can start building immediately
- You are guaranteed to save time and money with a simple and quick build time
- The Exercise Pools can be fitted directly on to any level hard surface
- The straps are stainless steel for long-lasting durability, ensuring anti-corrosion

The X-Stream Pool is a 2.426m x 3.916m pool. This comes with an X-Stream through the wall Counter Current System.

## Complete Exercise Pool Package with X-Stream Duo Pump System

Contains Structure Kit, iFlo Filtration Kit, Plain Liner option, Maintenance Kit and complete X-Stream Duo Counter Current System.

See our channel for our 5-part Premium Wooden Pool video installation

Pool Dimensions available on page 184

### X-Stream Exercise Pool\*

DISCOUNT CODE/ PRODUCT CODE	DESCRIPTION	PRICE EACH
L2 WSK0072	• Structure Kit with Brace Kit, contains stainless steel strap system, plus single pre-cut out for Duo X-Stream Counter Current Unit*	£6,650.00
K XST002K	• X-Stream Duo Kit c/w Control Unit, complete Plumbing Kit, 2 x Wiper Counter Current Pumps	£4,699.00

**Note:** More information on Counter Current Systems on pages 39-44

### Filtration Kit\*

DISCOUNT CODE/ PRODUCT CODE	DESCRIPTION	PRICE EACH
L2 WFK001	• iFlo Filter Pump Pack c/w Essential Plumbing* inc. glass filter media	£540.00
L2 WPU200K	• Wooden Pool Extra Pipework Kit	£164.00
L2 WFK001U	• Upgraded Argonaut and Premium Filter Pack c/w Essential Plumbing inc. glass filter media	£1,155.00

### Liner Options\*

DISCOUNT CODE/ PRODUCT CODE	DESCRIPTION	PRICE EACH
A PLI4181	• 30Thou Plain Liner 0.75mm* (24m <sup>2</sup> )	£877.20
A PLI418	• 30Thou Plain Liner with Tileband 0.75mm (24m <sup>2</sup> )	£1,017.60
A PLI4182	• 30Thou All-over Patterned Liner 0.75mm (24m <sup>2</sup> )	£1,221.60

### Maintenance Kit\*

DISCOUNT CODE/ PRODUCT CODE	DESCRIPTION	PRICE EACH
M WMK001	• Maintenance Pack & Starter Kit*	£167.50

### Light Package Options\*

DISCOUNT CODE/ PRODUCT CODE	DESCRIPTION	PRICE EACH
K2 MCLED01K	• Mini Brio + White LED Kit contains 1 white light c/w 100W Transformer & Deck Box Kit	£335.00
K2 MCRGB01K	• Mini Brio + RGB LED Kit c/w Remote contains 1 RGBW light c/w sync panel 100W Transformer & Deck Box Kit	£530.00

### Heating Options\*

DISCOUNT CODE/ PRODUCT CODE	DESCRIPTION	PRICE EACH
H2 HSI078	• HeatSeeker 7.8kW Inverter Heat Pump	£1,428.00
H E2-1-6	• Elecro Evolution Electric Heater 6kW	£637.57

\* Plastica give a 10 year parts only warranty to the timber structure. Terms & Conditions apply.

## Counter Current Units

- Operate with air switch button (not supplied)
- PINCC17 - Controls 1 x 3hp pump (13.4amp)
- PINCCDUO - Controls 2 x 3hp pumps (11amp) with one press of air switch, time delay between pumps to reduce start-up current
- Compact enclosure



### Counter Current Controllers

DISCOUNT CODE/ PRODUCT CODE	DESCRIPTION	PRICE EACH
K PINCC17	Counter Current Controller (single pump 13.4a)	£152.00
K PINCCDUO	Counter Current Controller (dual pump 11a)	£316.00

### ESPA Nadorsel

PALLET

DISCOUNT CODE/ PRODUCT CODE	DESCRIPTION	PRICE EACH
K NCP300	Nadorsel 300	£1,268.00



### ESPA Wiper 3

PALLET

DISCOUNT CODE/ PRODUCT CODE	DESCRIPTION	PRICE EACH
K WIP300	Wiper3 300 Single Phase 3HP	£766.00



See page 43 for further details

## Small Eco

10YR  
PRO-RATA  
WARRANTY\*

HEAVY  
ITEM



The Eco range of pools are specifically designed pool packages to give customers the luxury of a complete wooden pool package at a low cost. It measures compact 4m internally (Volume 11500L/2500galls)

Package contains:

- Redwood Wall Structure
- Two Piece Softwood Top
- Corner Cover Plates
- 0.5mm (20thou) Plain Blue Liner
- Internal Stainless Ladder
- External Softwood Ladder
- Felt Underlay for floor
- Skimmer and Return Fitting
- iFLO 500mm Sand Filter
- 6-way Multiport Valve
- 0.75hp Pump
- Flexible Pipe and Fittings
- Installation Manual



Pool Dimensions available on page 184

### Small Eco

DISCOUNT CODE/ PRODUCT CODE	DESCRIPTION	PRICE EACH
L3 EWP102K	Small Eco Kit	£4,705.00

\* Plastica give a 10 year parts only warranty to the timber structure. Terms & Conditions apply.

ABOVE  
GROUND

## Large Eco

10YR  
PRO-RATA  
WARRANTY\*

HEAVY  
ITEM



The Large Eco is a 5.5m octagonal internally, (Pool volume 21400L/4700galls) and is a great sized pool for most gardens at a fantastic budget.

Package contains:

- Redwood Wall Structure
- Two Piece Softwood Top
- Corner Cover Plates
- 0.50mm (20thou) Plain Blue Liner
- Internal Stainless Ladder
- External Softwood Ladder
- Felt Underlay for floor
- Skimmer and Return Fitting
- iFLO 500mm Sand Filter
- 6-way Multiport Valve
- 0.75hp Pump
- Flexible Pipe and Fittings
- Installation Manual



## Large Eco

DISCOUNT CODE/ PRODUCT CODE	DESCRIPTION	PRICE EACH
L3 EWP103K	🌳 Large Eco Kit	£5,750.00

Pool Dimensions available on page 184

ABOVE  
GROUND



Plastica  
www.plasticapools.net



# Large Stretched Eco

10YR  
PRO-RATA  
WARRANTY

HEAVY  
ITEM



The Large Stretched Eco is a great sized pool for families and more serious swimmers at a fantastic budget. (Volume 34200L/7523galls)

Package contains:

- Redwood Wall Structure
- Two Piece Softwood Top
- Corner Cover Plates
- 0.50mm (20thou) Plain Blue Liner
- Internal Stainless Ladder
- External Softwood Ladder
- Felt Underlay for floor
- Skimmer and Return Fitting
- iFLO 500mm Sand Filter
- 6-way Multiport Valve
- 0.75hp Pump
- Flexible Pipe and Fittings
- Installation Manual

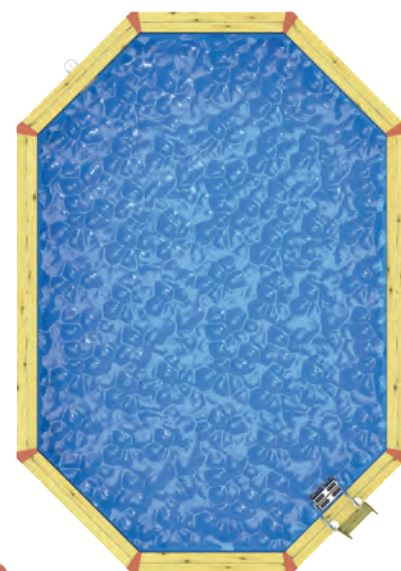

ABOVE  
GROUND

## Large Stretched Eco

DISCOUNT CODE/ PRODUCT CODE	DESCRIPTION	PRICE EACH
L3 EWP104K	🔧 Large Stretched Eco Kit	£7,855.00

Plastica give a 10 year parts only warranty to the timber structure. Terms & Conditions apply.

Pool Dimensions available on page 184

# Wooden Fun Pool

5 YR  
PRO-RATA  
WARRANTY\*

PALLET



- Redwood Walls & Structure
- Single Piece Softwood Top
- Mid Blue 20 thou Liner and Felt Underlay
- Pipework and fittings
- Installation Guide
- Can be positioned on a flat level lawn
- Models include skimmer and inlet cut-out
- Packages includes iFlo Junior 310mm Sand Filter

See ladders on page 192

This pool will be delivered on a lorry with a tail lift, please contact us for a quote if a hi-ab delivery is required

FUN POOL DELIVERY Carriage will be charged at standard pallet rate

An affordable above ground pool, aesthetically pleasing to compliment your garden. Can be used above ground or submerged in ground.

Fun pools come with the same great 10 year warranty and quality of manufacture as our Premium Wooden Pools.



10ft Fun Pool - 4ft depth

## Fun Pool

DISCOUNT CODE/ PRODUCT CODE	DESCRIPTION	PRICE EACH
L5 WFP010UK	10ft Fun Pool - 3ft depth 7m <sup>3</sup>	£1,650.00
L5 WFP0104UK	10ft Fun Pool - 4ft depth 10m <sup>3</sup>	£1,999.00



10ft Fun Pool

iFlo Junior 310



AG Mini



Recommended Ladders  
36" & 42" Ladder – 28075  
48" & 52" – 28076  
(See page 192)



Recommended Heater  
Electro Nano Plug n Play Heater -  
N-AGP-UK-T

Plastica give a 5 year parts only warranty to the timber structure. Terms & Conditions apply.

ABOVE  
GROUND



## Wooden Pool Covers

### Nazca 4 x 2m

DISCOUNT/PRODUCT CODE	DESCRIPTION	
R WPC442	400 Blue Cover for Nazca Wooden Pool	£121.37
R WPC542	500 Sol+Guard Cover for Nazca Wooden Pool	£170.91
I2 PWD142NZ	Deluxe Tarp AG WD Cover for Nazca Wooden Pool	£253.80
V PSV142NZ*	Poolsaver Safety Cover for Nazca 4m x 2m	£1,444.30

### Nazca 8 x 2m

R WPC482	400 Blue Cover for Nazca Wooden Pool	£242.74
R WPC582	500 Sol+Guard Cover for Nazca Wooden Pool	£341.82
I2 PWD182NZ	Deluxe Tarp AG WD Cover for Nazca Wooden Pool	£486.45
V PSV182NZ*	Poolsaver Safety Cover for Nazca 8m x 2m	£1,444.30

### Nazca 8 x 4m

R WPC484	400 Blue Cover for Nazca Wooden Pool	£485.49
R WPC584	500 Sol+Guard Cover for Nazca Wooden Pool	£683.63
I2 PWD184NZ	Deluxe Tarp AG WD Cover for Nazca Wooden Pool	£846.00
V PSV184NZ*	Poolsaver Safety Cover for Nazca 8m x 4m	£2,110.90

### Knightsbridge / Small Eco

R WPC102	400 Blue Cover for Knightsbridge Wooden Pool 14m <sup>2</sup>	£212.40
R WPC101	500 Sol+Guard Cover for Knightsbridge Wooden Pool 14m <sup>2</sup>	£245.70
I2 PWD001WP	Deluxe Tarp AG WD Cover for Knightsbridge Wooden Pool 21m <sup>2</sup>	£444.15
V PSV101*	Poolsaver Cover for Knightsbridge Wooden Pool 18m <sup>2</sup>	£2,812.00

### Hampstead / Large Eco

R WPC802	400 Blue Cover for Hampstead Wooden Pool 26m <sup>2</sup>	£394.46
R WPC801	500 Sol+Guard Cover for Hampstead Wooden Pool 26m <sup>2</sup>	£555.45
I2 PWD008WP	Deluxe Tarp AG WD Cover for Hampstead Wooden Pool 35m <sup>2</sup>	£740.25
V PSV801*	Poolsaver Cover for Hampstead Wooden Pool 32m <sup>2</sup>	£2,812.00

### Large Stretched Eco Covers

R WPC902	400 Blue Cover for Large Eco Stretched 39m <sup>2</sup>	£591.69
R WPC901	500 Sol+Guard Cover for Large Eco Stretched 39m <sup>2</sup>	£833.18
I2 PWD009WP	Deluxe Tarp AG WD Cover for Large Eco Stretched 49m <sup>2</sup>	£1,036.35
V PSV901*	Poolsaver Cover for Large Eco Stretched 46m <sup>2</sup>	£3,800.00

### Belgravia Covers

R WPC402	400 Blue Cover for Belgravia Wooden Pool 21m <sup>2</sup>	£318.60
R WPC401	500 Sol+Guard Cover for Belgravia Wooden Pool 21m <sup>2</sup>	£448.63
I2 PWD004WP	Deluxe Tarp AG WD Cover for Belgravia Wooden Pool 29m <sup>2</sup>	£613.35
V PSV401*	Poolsaver Cover for Belgravia Wooden Pool 26m <sup>2</sup>	£2,812.00

### Bayswater Covers

R WPC502	400 Blue Cover for Bayswater Wooden Pool 24m <sup>2</sup>	£364.12
R WPC501	500 Sol+Guard Cover for Bayswater Wooden Pool 24m <sup>2</sup>	£512.72
I2 PWD005WP	Deluxe Tarp AG WD Cover for Bayswater Wooden Pool 33m <sup>2</sup>	£697.95
V PSV501*	Poolsaver Cover for Bayswater Wooden Pool 30m <sup>2</sup>	£2,812.00

### Westminster Covers

R WPC602	400 Blue Cover for Westminster Wooden Pool 38m <sup>2</sup>	£576.52
R WPC601	500 Sol+Guard Cover for Westminster Wooden Pool 38m <sup>2</sup>	£811.81
I2 PWD006WP	Deluxe Tarp AG WD Cover for Westminster Wooden Pool 49m <sup>2</sup>	£1,036.35
V PSV601*	Poolsaver Cover for Westminster Wooden Pool 45m <sup>2</sup>	£3,717.45

### X-Stream Exercise Pool Covers

R WPC702	400 Blue Cover for X-Stream Exercise Wooden Pool 10m <sup>2</sup>	£151.72
R WPC701	500 Sol+Guard Cover for X-Stream Exercise Wooden Pool 10m <sup>2</sup>	£213.64
I2 PWD007WP	Deluxe Tarp AG WD Cover for X-Stream Exercise Wooden Pool 15m <sup>2</sup>	£317.25
V PSV701*	Poolsaver Cover for X-Stream Exercise Wooden Pool 13m <sup>2</sup>	£2,812.00

### Chelsea Pool Covers

R WPC1012	400 Blue Cover for Chelsea Wooden Pool 50m <sup>2</sup>	£758.58
R WPC1011	500 Sol+Guard Cover for Chelsea Wooden Pool 50m <sup>2</sup>	£1,068.18
I2 PWD1011WP	Deluxe Tarp AG WD Cover for Chelsea Wooden Pool 63m <sup>2</sup>	£1,332.45
V PSV1011*	Poolsaver Cover for Chelsea Wooden Pool 58m <sup>2</sup>	£4,791.00



All covers are shaped to fit

Grey

Pastel Green

Beige

Blue

Green

ABOVE  
GROUND

**Poolsaver Covers\*** are available in a colour Grey and Blue, Green, Pastel Green and Beige. Please add which colour you require when ordering, for example: GY for grey, B for blue, BG for beige, G for Green and PG for Pastel Green onto the end of the code PSV or PSZV codes for Poolsaver cover colours.

## Wooden Pool Dimensions

HEAVY  
ITEM

When purchasing a Plastica wooden pool, you will be sure to find the help you need to build your product to a high standard.

If the wooden pool requires metal braces, you can pre order them to be delivered before the rest of the pool package you have chosen. This means you can build the recommended concrete base and position your metal braces, well before having your pool delivered. This can save you time and for smaller sites can save you working space.

The wooden structure does not require any further treatment. On Premium Pools we recommend the use of decking oil to keep your hard wood top shelving in beautiful condition.

All pools are supplied with plan drawing laminates and a self-build installation manual.

For further technical information on Plastica Wooden Pools you can go to [www.woodenpools.net](http://www.woodenpools.net). There you can find information such as Metal Brace positions, concrete base drawings, Installation Manuals and more.

	Pallets	External		Internal			Concrete Base		
		Length	Width	Length	Width	Height	Length	Width	Thickness
<b>Nazca 4 x 2m</b>	3	4.5m	2.5m	4m	2m	1.35m	4.739m	2.739m	0.150m
<b>Nazca 8 x 2m</b>	4	8.5m	2.5m	8m	2m	1.35m	8.739m	2.739m	0.150m
<b>Nazca 8 x 4m</b>	4	8.5m	4.5m	8m	4m	1.35m	8.739m	4.739m	0.150m
<b>Knightsbridge</b>	2	4.213m	4.213m	3.695m	3.695m	1.177m	4.383m	4.382m	0.150m
<b>Belgravia</b>	4	6.082m	4.212m	5.564m	3.695m	1.312m	6.252m	4.382m	0.150m
<b>Bayswater</b>	4	7.082m	4.212m	6.564m	3.695m	1.312m	7.252m	4.482m	0.150m
<b>Westminster</b>	4	8.719m	5.129m	8.201m	4.611m	1.312m	8.889m	5.299m	0.150m
<b>Chelsea</b>	4	10.518m	5.518m	10.000m	5.000m	1.312m	10.688m	5.688m	0.150m
<b>Exercise</b>	3	4.434m	2.994m	3.916m	2.426m	1.177m	4.604m	3.114m	0.150m
<b>Extreme Exercise</b>	3	4.434m	2.994m	3.916m	2.426m	1.177m	4.604m	3.114m	0.150m
<b>Eco Small Octagon</b>	2	4.240m	4.240m	3.695m	3.695m	1.177m	4.383m	4.383m	0.150m
<b>Eco Large Octagon</b>	2	5.600m	5.600m	5.082m	5.082m	1.177m	5.770m	5.770m	0.150m
<b>Eco Large Stretched</b>	4	8.045m	5.600m	7.527m	5.082m	1.177m	8.215m	5.770m	0.150m
<b>10ft Fun Pool ft Deep</b>	1	3.046m	3.046m	2.817m	2.817m	0.899m	3.734m	3.734m	0.150m
<b>10ft Fun Pool 4ft Deep</b>	1	3.046m	3.046m	2.817m	2.817m	1.239m	3.734m	3.734m	0.150m



ABOVE  
GROUND

## Prism Frame Pools

PALLET



All filter pump units must be placed 2 metres away from the pool. We recommend filtration is turned off when pool is in operation.

- Easy to set up
- Semi-rigid structure
- Made from re-reinforced PVC
- Galvanised steel frame
- 12' complete with 2m<sup>3</sup> per hour filter pump and ladder (41.3kg)
- 15' comes with 3.8m<sup>3</sup> per hour filter pump, ladder, ground cloth, cover (72.4kg)
- 18' comes with 5.6m<sup>3</sup> per hour filter pump unit, safety ladder, ground cover, pool cover (99.7kg)

### Prism Frame Pools

DISCOUNT CODE/ PRODUCT CODE	DESCRIPTION	PRICE EACH
L 26716NP	12' x 39"	£391.00
L 26726NP	15' x 48"	£682.00
L 26732NP	18' x 48"	£843.00

## Easy Set Pools



28132NP 12' x 30" Easy Set Pool

**Note:** All filter pump units must be placed 2 metres away from the pool. We recommend filtration is turned off when pool is in operation.

- Ten minute set up
- Supplied with a pump-filtration system
- Made from reinforced PVC
- 8' supplied as pool only (5.6kg)
- 12' complete with 2m<sup>3</sup> per hour filter pump (14.9kg)
- 15' complete with 3.78m<sup>3</sup> per hour cartridge filter pump unit, safety ladder, ground cloth, pool cover (46.9kg)

### Easy Set Pools

DISCOUNT CODE/ PRODUCT CODE	DESCRIPTION	PRICE EACH
L 28106NP	8' x 24"	£44.00
L 28132NP	12' x 30"	£160.00
L 26168UK	15' x 48"	£470.00

ABOVE  
GROUND

## Relax Splasher Water Treatment Kit

- 500g Stabilised Chlorine Granules
- 750g pH Minus
- 500g pH Plus
- 500ml Algicide
- pH / Chlorine Test Strips
- Guide to Above Ground Pool Care



### Relax Splasher Water Treatment Kit

DISCOUNT CODE/ PRODUCT CODE	DESCRIPTION	PRICE EACH
T5 RCH080	Relax Splasher Pool Water Treatment Kit	£32.78
T5 RCH084	Box of 4 Relax Splasher Pool Water Treatment Kits	£114.00

## Floating Fountain



Grecian Triple Tier Fountain – NAF100



Grecian Triple Tier Fountain – NAF100

### Floating Fountain

DISCOUNT CODE/ PRODUCT CODE	DESCRIPTION	PRICE EACH
L NAF100	Grecian Triple Tier Fountain	£34.00

## Frost Protection

- Switches pump on when the water falls below set temperature
- Supplied complete with temperature probe
- Digital display of temperature
- Low and high set point are adjustable (on/off)

### Frost Stat

DISCOUNT CODE/ PRODUCT CODE	DESCRIPTION	PRICE EACH
K DHG-2	Frost Protection Thermostat Controller	£124.00



## Skimmers



Standard Skimmer – ENS100

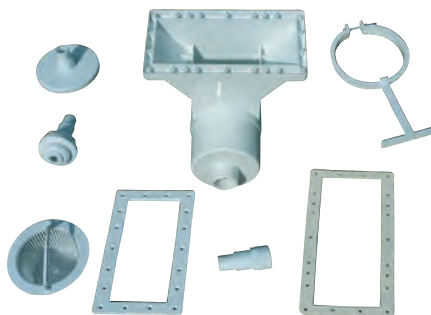

Wide Angle Skimmer – ENS110



Surface Skimmer – 28000/E

### Through Wall Skimmer

DISCOUNT CODE/ PRODUCT CODE	DESCRIPTION	PRICE EACH
L ENS100	Standard (1.5" female threaded outlet)	£45.00
L ENS110	Wide Angle (1.5" female threaded outlet)	£53.00

### Wall Mount Surface Skimmer

DISCOUNT CODE/ PRODUCT CODE	DESCRIPTION	PRICE EACH
L 28000/E	Wall Mount Surface Skimmer	£28.00



Surface Skimmer – 28000/E

## Cartridge Filter Pump Units

- Easy installation
- Double insulated with air release valve
- Automatic timer

28602BS suitable for 10' Metal Frame, 8' & 10' Easy Set Pool  
 28604BS suitable for 12' Metal Frame, 8' & 12' Easy Set Pool  
 28638BS suitable for 15' Metal Frame & 15' Easy Set Pool  
 28636BS suitable for 18' Metal Frame Pool

### Cartridge Filter Pump Units

DISCOUNT CODE/ PRODUCT CODE	DESCRIPTION	PRICE EACH
L 28602BS	1,136 litres per hour	£50.00
L 28604BS	1,798 litres per hour	£55.00
L 28638BS	2,839 litres per hour	£70.00
L 28636BS	4,466 litres per hour	£130.00
L 29059	Accessory Hose 1.5m x 32mm (1.25")	£15.00
L 29060	Accessory Hose 1.5m x 38mm (1.5")	£16.30



28604BS



28638BS

Type H filter cartridge fits filter model 28602

Plastica's Relax Pool filter cartridges are compatible with filter models 28604, 28638 and 28636

Type B filter cartridge fits filter model 28634

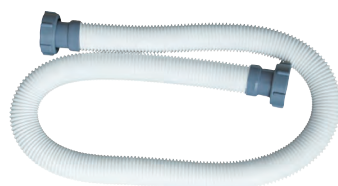

Accessory Hose - 29060

### Intex Cartridge for Above Ground Filter Pump Units

DISCOUNT CODE/ PRODUCT CODE	DESCRIPTION	PRICE EACH
S1 29007	Intex Type H Filter Cartridge	£4.95
S1 29005	Intex Type B Filter Cartridge	£11.40

### Relax Cartridge for Above Ground Filter Pump Units

DISCOUNT CODE/ PRODUCT CODE	DESCRIPTION	PRICE EACH
RFINTA	Relax Filter Cartridge	£2.90
RFINTAPK2	Relax Filter Cartridge Pack of 2	£5.70

ABOVE  
GROUND

# Krystal Clear® Sand Filter Pump Packs

- Suitable for above ground pools
- 6-way multiport valve
- 24 hour automatic timer
- Pressure gauge
- Complete with connectors and flexible pipe for Intex pool

### 26646 Specification

- 6m³ per hour flow rate
- 12" (305mm) diameter tank
- 0.30hp pump
- 23kg sand capacity
- Basket included on pump

## Krystal Clear® Sand Filter Pump Packs

DISCOUNT CODE/ PRODUCT CODE	DESCRIPTION	PRICE EACH
L 26646	0.30hp 6m³ per hour filter pump pack	£309.00
L 26648	0.60hp 8m³ per hour filter pump pack	£377.00
L 26652	0.75hp Pump, 9.2m³ per hour Filter pump pack	£399.00

### 26648 Specification

- 8m³ per hour flow rate
- 14" (360mm) diameter tank
- 0.60hp pump
- 35kg sand capacity
- Basket included on pump

### 26652 Specification

- 9.2m³ per hour flow rate
- 16" (410mm) diameter tank
- 0.75hp pump
- 55kg sand capacity
- Basket included on pump



6-way valve



Pressure Gauge



Krystal Clear – 26 646 Filter pump pack



Heavy Duty Tank



Strainer Basket

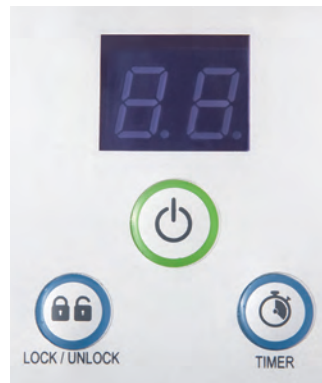

Built-in Timer



Powerful Motor

ABOVE GROUND

## Krystal Clear® Sand Filter Pump Packs

- Suitable for above ground pools
- 6-way multiport valve
- 24 hour automatic timer
- Pressure gauge
- Complete with connectors and flexible pipe for Intex pool

### Krystal Clear® Sand Filter Pump Packs

DISCOUNT CODE/ PRODUCT CODE	DESCRIPTION	PRICE EACH
L 26644	0.25hp 4m <sup>3</sup> per hour filter pump pack	£259.00

### Rigid Pipe Conversion Kit

DISCOUNT CODE/ PRODUCT CODE	DESCRIPTION	PRICE EACH
L AFP071	Rigid pipe conversion kit	£38.95



Converts to 1.5" rigid ABS pipe



Rigid Pipe Conversion Kit – AFP071



Krystal Clear – 26644

#### 26644 Specification

- 4m<sup>3</sup> per hour flow rate
- 10" (254mm) diameter tank
- 0.25hp pump
- 12kg sand capacity

Connectors and flexible pipe included



## iFlo Junior 310 Filter Pump Pack

- An excellent value 250kW 0.33hp pump
- Quality 7-way multi-port valve, connecting hose, pressure gauge and base plate
- 310mm filter tank
- Adaptors for pool hoses 32-38mm connection
- Simple to install
- Ultra quiet self priming pump with pre-filter

### iFlo Junior 310 Filter Pump Pack

DISCOUNT CODE/ PRODUCT CODE	DESCRIPTION	PRICE EACH
O2 SFP310	iFlo Junior 310 Filter Pump Pack	£277.00

The max flow rate of the filter is 5.2m<sup>3</sup> per hour. (This is limited by site specific factors including size of pipe work, bends, other items installed that the water is passed through).



**Note:** A non-return valve should be fitted after the pump to prevent the impeller from unwinding if strong backflow occurs.

## iFlo® 500 Filter Pump Pack

- Outstanding value 550kW 0.75hp pump
- Quality 6-way multi-port valve, connecting hose, pressure gauge and base plate
- 500mm filter tank
- Simple to install
- Ultra quiet self priming pump with pre-filter

### iFlo 500

DISCOUNT CODE/ PRODUCT CODE	DESCRIPTION	PRICE EACH
O2 SFP500	Filter Pump Pack	£408.50

The max flow rate of the filter is 9.3m<sup>3</sup> per hour. (This is limited by site specific factors including size of pipe work, bends, other items installed that the water is passed through).



ABOVE  
GROUND



## Nano Plug & Play Heater

- Grade 1 titanium elements
- Grade 1 titanium flow tube
- Safety thermal cut-out included (manual reset)
- 2m power cord with UK plug
- 230V single phase 13amp load
- Flow switch - no pump interlock required
- Fully pre-wired
- Control thermostat
- 2 year warranty



### Nano Plug & Play Heater

DISCOUNT CODE/ PRODUCT CODE	DESCRIPTION	PRICE EACH
H N-AGP-UK-T	3kW	£380.07

Supplied connection options:

- 1.5" female threaded
- 50mm plain female socket unions
- 1.5" plain female socket unions
- 1.5" / 1.25" hoesetail connectors

**Note:** The Nano Plug & Play can be mounted horizontal or vertical

## Solar Pod™

- For above ground pools up to 4,500 litres
- Compact size of 580mm x 580mm
- Coil made of strong polypropylene
- Strong transparent polycarbonate dome
- Easy connection
- Connect multiple units for larger pools
- Works with existing pool pump
- Minimal tools required (Phillips screwdriver and silicon lubricant)
- Tilts to achieve best angle for sun
- No servicing required (other than winterising)



- Solar Pod includes:
- 1m and 0.36m hoses
  - Main base with stand
  - Side hose connector x2
  - 1.25" to 1.5" hose reducer
  - Hose ID 38mm
  - Collared tube adaptor
  - Clear dome
  - Hose clamps
  - Solar protection cover

### Solar Pod™

DISCOUNT CODE/ PRODUCT CODE	DESCRIPTION	PRICE EACH
K POD001	☀ Solar Pod	£118.00
K POD051	☀ Solar Pod Accessories Kit	£16.00
K POD053	☀ Additional Hose (Short - 375mm x 1.5")	£8.50
K POD054	☀ Additional Hose (Long - 975mm x 1.5")	£17.80



Solar Pod Accessories Kit – POD051

**Note:** For use with Intex standard filtration you will need to purchase an Intex 1.5" hose 29060 (see page 187). The heating efficiency of Solar Pods is directly related to climatic conditions. Plastica cannot guarantee that solar heating will maintain a constant pool temperature and recommend installation of a primary heat source.

**Note:** Any more than 3 Solar Pods should be plumbed in parallel.

ABOVE  
GROUND

## Solar Pod™ Plus

- For above ground pools up to 9,000 litres
- 780mm x 780mm x 450mm
- Coil made of strong polypropylene
- Strong transparent dual polycarbonate domes
- Easy connection
- Connect multiple units for larger pools
- Works with existing pool pump
- Minimal tools required (Phillips screwdriver and silicon lubricant)
- Tilts to achieve best angle for sun
- No servicing required (other than winterising)
- Reflective underside for optimum heat gain



- Solar Pod Plus includes:
- Hose ID 38mm
  - Main base with stand
  - 1.25" to 1.5" hose reducer
  - Collared tube adaptor
  - Hose clamps
  - 1m and 0.36m hoses
  - Side hose connector x2
  - Clear dome
  - Solar protection cover

### Solar Pod™ Plus

DISCOUNT CODE/ PRODUCT CODE	DESCRIPTION	PRICE EACH
K POD002	Solar Pod Plus	£278.00
K POD052	Solar Pod Accessories Kit	£16.00
K POD053	Additional Hose (Short - 375mm x 1.5")	£8.50
K POD054	Additional Hose (Long - 975mm x 1.5")	£17.80



Solar Pod Plus Accessories Kit – POD052

**Note:** The heating efficiency of Solar Pods is directly related to climatic conditions. Plastica cannot guarantee that solar heating will maintain a constant pool temperature and recommend installation of a primary heat source.

## 1.7"/43mm Wooden Pool Ladder

MADE TO ORDER



- 316 stainless steel tube
- Suitable for any depth of pool
- Easily removable for cover installation

### 1.7"/43mm Wooden Pool Ladder

DISCOUNT CODE/ PRODUCT CODE	DESCRIPTION	PRICE EACH
D PSL436RWS	3-Tread	£714.00
K ESC043	Flange Cover Plate	£19.80



Removable ladder

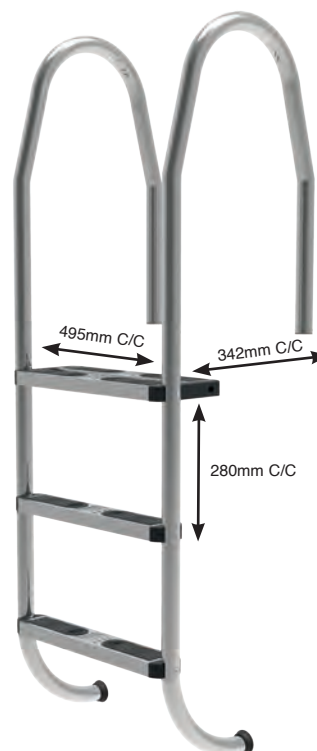

ABOVE GROUND



## 1.7"/43mm Decking Ladder

- 316 stainless steel adjustable ladder
- 48"-52" depth pools
- Level of decking can be up to 0.2m below top of pool
- Stainless steel sliding flange adjusts height

### 1.7"/43mm Decking Ladder

DISCOUNT CODE/ PRODUCT CODE	DESCRIPTION	PRICE EACH
D PSL434DS	43mm 4-Tread Decking Ladder	£722.00



## Above Ground Pool Ladders

### Above Ground Pool Ladders

DISCOUNT CODE/ PRODUCT CODE	DESCRIPTION	PRICE EACH
L 28075	36" and 42" with removable steps	£73.00
L 28076	48" with removable steps	£82.00
L 28074	52" with removable steps	£82.00

- Coated steel frame
- High impact plastic steps
- For pool walls 36" to 52" high
- Removable steps



36" & 42" Ladder - 28075

48" Ladder - 28076

## Foot Bath

- Reduces debris and dirt from entering the pool
- Perfect for all Intex ladders
- Anti-slip bottom for safety
- Size 56cm x 46cm x 9cm
- 11.5 litres water capacity

### Foot Bath

DISCOUNT CODE/ PRODUCT CODE	DESCRIPTION	PRICE EACH
L 29080	Foot Bath	£7.60



ABOVE GROUND



## Above Ground Pool Solar Covers

- Budget solar cover for above ground pools
- Reduce heating costs and chemical usage
- 200 micron
- 0.22kg per sq.m
- 1 year pro-rata warranty (UK & Eire only)

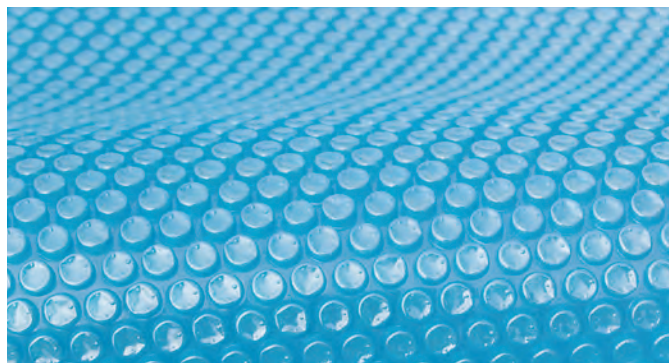

**Note:** These covers require trimming on site.

### Oval

DISCOUNT CODE/ PRODUCT CODE	DESCRIPTION	PRICE EACH
L6 ASC112	10' x 15'	£95.88
L6 ASC113	10' x 16'	£102.54
L6 ASC114	12' x 18'	£119.36
L6 ASC117	12' x 20'	£120.95
L6 ASC122	12' x 22'	£122.96
L6 ASC124	12' x 24'	£131.28
L6 ASC126	12' x 28'	£145.26
L6 ASC132	16' x 28'	£179.18
L6 ASC118	15' x 30'	£173.17
L6 ASC134	16' x 32'	£193.05
L6 ASC136	18' x 33'	£214.41

### Diameter

DISCOUNT CODE/ PRODUCT CODE	DESCRIPTION	PRICE EACH
L6 ASC008	8'	£25.31
L6 ASC010	10'	£39.47
L6 ASC012	12'	£52.39
L6 ASC015	15'	£75.70
L6 ASC016	16'	£88.56
L6 ASC018	18'	£132.16
L6 ASC024	24'	£205.32

## Wooden Pool Solar Covers



- Budget solar cover for wooden pools
- Reduce heating costs and chemical usage
- 200 micron
- 0.22g per sq.m
- 1 year pro-rata warranty (UK & Eire only)



**Note:** These covers require trimming on site.

### Nazca Pools

DISCOUNT CODE/ PRODUCT CODE	DESCRIPTION	PRICE EACH
L6 WPC242	Cover for Nazca 4m x 2m	£49.21
L6 WPC282	Cover for Nazca 8m x 2m	£110.27
L6 WPC284	Cover for Nazca 8m x 4m	£152.46

### Premium Wooden Pool

DISCOUNT CODE/ PRODUCT CODE	DESCRIPTION	PRICE EACH
L6 WPC100	Cover for 4m Knightsbridge	£65.90
L6 WPC200	Cover for 5m Mayfair	£102.42
L6 WPC300	Cover for 6m Kensington	£117.59
L6 WPC400	Cover for 5.5m x 3.6m Belgravia	£99.36
L6 WPC500	Cover for 6.5m x 3.6m Bayswater	£118.41
L6 WPC600	Cover for 8.1m x 4.6m Westminster	£138.06
L6 WPC700	Cover for 4.2m x 3.9m Exercise Pool	£57.29
L6 WPC800	Cover for 5.5m Hampstead Pool	£149.68

ABOVE  
GROUND

## NAZCA Safety Pool Cover

The Nazca safety cover is a manually operated tracked safety cover that has been developed to fit our 4m x 2m and 8m x 2m Nazca wooden pools. The cover system is perfect for preventing children and animals from accessing the pool and also provides added protection against heat loss, debris ingress and algae growth. Providing the water is kept at a normal operating level, the cover can also be used as a winter debris cover. A safety cover pump is required to keep standing water off the cover. Excess water on top of the cover will make it difficult to use and could lead to damage or injury. Suitable precautions should be taken to prevent frost damage.

For above ground/standard Nazca installations, the mechanism can be mounted horizontally (as shown below) giving a stylish, low profile finish.

For deck level/submerged Nazca installations, the mechanism can be mounted on the decking.

The cover comes in grey as standard to compliment the colour of the timber. If another colour is specifically required, please contact us and we can provide a quotation.

- Simple to install
- Prevents ingress of debris
- Low maintenance
- Blocks light into pool, minimising the use of water treatment

### Nazca Safety Pool Cover

DISCOUNT CODE/ PRODUCT CODE	DESCRIPTION	PRICE EACH
V PCP002	Pool Cover Pump with 10m power cord*	£328.00
V NSC001	4 x 2m Nazca Safety Pool Cover	POA
V NSC002	8 x 2m Nazca Safety Pool Cover	POA



\*For details on the Pool Cover Pump see page 154 of the Covers section.



ABOVE  
GROUND

All our premium, ECO and NAZCA pools will be delivered on a hi-ab. Delivery will be booked once the complete pool kit is ready for despatch. For delivery costs to Europe, please contact our Export department on [export@plasticapools.net](mailto:export@plasticapools.net).

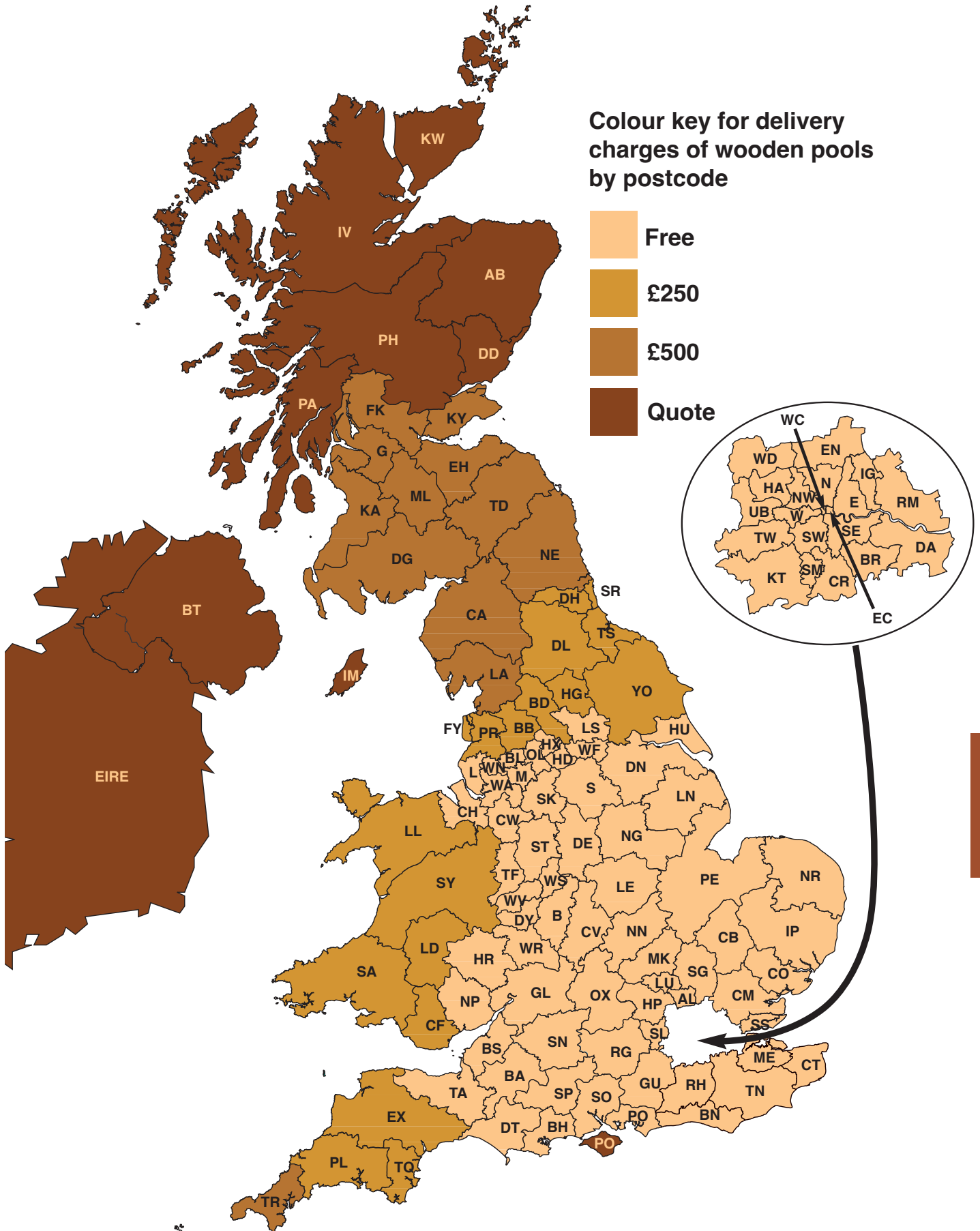

ABOVE  
GROUND

## Premium Reel System

BULKY

- Anti-spin locking device on wheels
- Complete with connectors for new or existing covers
- Tube extends from 3.66m to 5.49m
- Maximum area of cover 50 sq.m.

### Above Ground Reel

DISCOUNT CODE/ PRODUCT CODE	DESCRIPTION	PRICE EACH
G2 ERC310	Above Ground	£527.00

- 2 fixed stands
- Height adjustable
- Fixed to the pool side

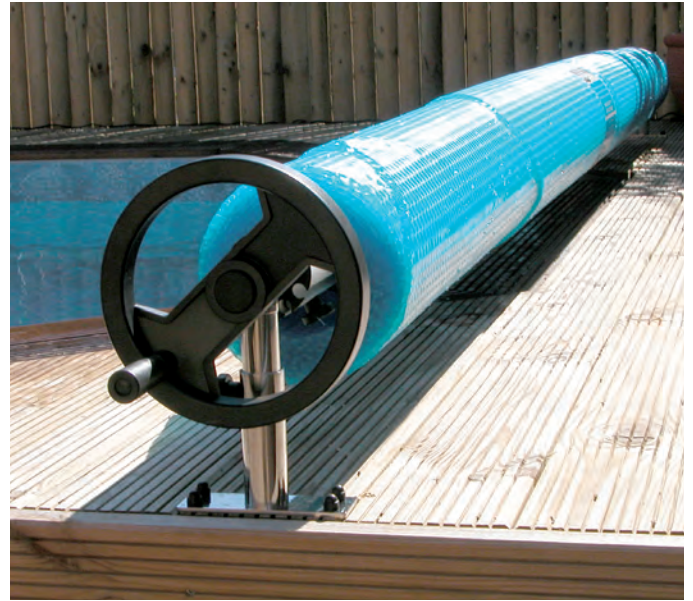

Above Ground – ERC310

### Deck Reel

DISCOUNT CODE/ PRODUCT CODE	DESCRIPTION	PRICE EACH
G2 ERC320	Decking	£609.00

- Ideal for wooden pools or decked surrounds
- One fixed end fastens to the surround
- Universal joint enables reel to be moved away from pool side



Decking Reel – ERC320

## Deluxe Above Ground Pool Covers

MADE TO ORDER

- New made to measure Above Ground Pool covers
- Choice of materials
- Mesh Weave material that allows rainwater to pass through
- Deluxe Tarpaulin material that blocks all debris and light
- Use during the Summer or Winter
- Comes complete with elasticated tie-downs and wall clips

### Deluxe Above Ground Pool Covers

DISCOUNT CODE/ PRODUCT CODE	DESCRIPTION	PRICE EACH
12 PWD100	Mesh Weave Above Ground Debris per m <sup>2</sup>	£19.80
12 PWD200	Deluxe Tarpaulin Above Ground Debris per m <sup>2</sup>	£21.15



ABOVE  
GROUND

## Intex Winter Debris Covers

### Easy Set

DISCOUNT CODE/ PRODUCT CODE	DESCRIPTION	PRICE EACH
L 28020	Intex Winter Debris Cover 8ft Ø	£11.50
L 28022/E	Intex Winter Debris Cover 12ft Ø	£18.00
L 28023/E	Intex Winter Debris Cover 15ft Ø	£25.00

### Metal Frame

DISCOUNT CODE/ PRODUCT CODE	DESCRIPTION	PRICE EACH
L 28031	Intex Winter Debris Cover 12ft Ø	£21.50
L 28032	Intex Winter Debris Cover 15ft Ø	£30.00



## Above Ground Winter Debris Covers

- Woven polyethylene
- Comes complete with Winch and Cable

### Above Ground WDC Oval

DISCOUNT CODE/ PRODUCT CODE	DESCRIPTION	PRICE EACH
L2 PWA214	Above Ground Winter Debris Cover 8ft x 12ft	£51.00
L2 PWA215	Above Ground Winter Debris Cover 10ft x 15ft (Exercise)	£72.50
L2 PWA224	Above Ground Winter Debris Cover 12ft x 24ft	£127.00
L2 PWA225	Above Ground Winter Debris Cover 15ft x 21ft (Belgravia)	£155.00
L2 PWA229	Above Ground Winter Debris Cover 16ft x 28ft (Bayswater)	£176.00
L2 PWA230	Above Ground Winter Debris Cover 15ft x 30ft	£175.00
L2 PWA232	Above Ground Winter Debris Cover 16ft x 32ft	£189.00
L2 PWA233	Above Ground Winter Debris Cover 18ft x 33ft (Westminster)	£220.00



### Above Ground WDC Diameter

DISCOUNT CODE/ PRODUCT CODE	DESCRIPTION	PRICE EACH
L2 PWA112	Above Ground Winter Debris Cover 12ft Ø	£75.00
L2 PWA115	Above Ground Winter Debris Cover 15ft Ø (Knightsbridge)	£96.00
L2 PWA116	Above Ground Winter Debris Cover 16ft Ø	£115.00
L2 PWA118	Above Ground Winter Debris Cover 18ft Ø (Mayfair)	£126.00
L2 PWA120	Above Ground Winter Debris Cover 21ft Ø (Kensington)	£161.00
L2 PWA124	Above Ground Winter Debris Cover 24ft Ø	£190.00

### Winch & Cable

DISCOUNT CODE/ PRODUCT CODE	DESCRIPTION	PRICE EACH
K ACW1001	Aluminium Cable Winch	£9.00
K VCCC100	Vinyl Coated Cover Cable 100ft	£31.00

**Note:** These covers are not porous so a cover pump can be used to remove excess water (page 154).

### Inflatable Float Pillow

DISCOUNT CODE/ PRODUCT CODE	DESCRIPTION	PRICE EACH
L PWA301	0.9m x 1.2m inflated	£27.95

**Note:** Two pillows are recommended for ovals over 12' x 20'.

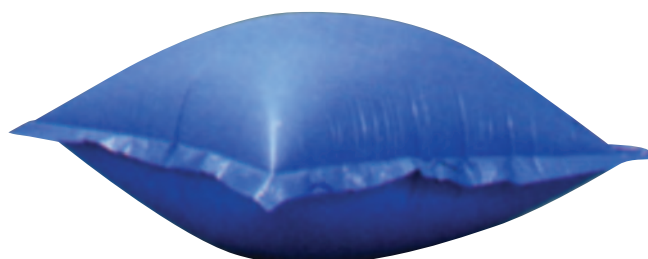

ABOVE  
GROUND

## Suction Cleaner

- Connects to skimmer or dedicated suction line
- Easy installation
- Quiet operation
- Suitable for all pool types
- Supplied with 10m of hose in sections

### Suction Cleaner

DISCOUNT CODE/ PRODUCT CODE	DESCRIPTION	PRICE EACH
K PAC002	Cleaner	£149.00

**Note:** Requires a minimum of 0.5hp pump for correct operation.



## Pool Drain Pump

- Pumps up to 3595 litres (950 gallons) of water per hour
- Power cord length 7.6m
- Maximum operating depth 1.22m (4ft)
- IPX8 waterproof housing
- Includes 32mm x 5m drain hose
- Adaptor for garden hose attachment
- Shelf box

### Pool Drain Pump

DISCOUNT CODE/ PRODUCT CODE	DESCRIPTION	PRICE EACH
K 28606BS	Pool Drain Pump	£56.00



## Intex Standard Pool Maintenance Kits

- 2.39m Telescopic Pole
- Interchangeable vacuum and skimmer heads
- For use with pools up to 16'



### Intex Pool Maintenance Kit

DISCOUNT CODE/ PRODUCT CODE	DESCRIPTION	PRICE EACH
L 28022/E	Standard	£18.00

## Intex Deluxe Pool Maintenance Kits

- 2.79m Telescopic Pole
- Vacuum sucks debris off pool wall and through filter
- Durable and deep mesh skimmer net
- Attaches to the pool outlet connector with a 7.5m hose
- For use with pools up to 18'
- Requires a pump with minimum flow rate of 800 gallons p/h



### Intex Pool Maintenance Kit

DISCOUNT CODE/ PRODUCT CODE	DESCRIPTION	PRICE EACH
L 28003/E	Deluxe	£55.50

## Hand Held Vacuum Kit

- Suitable for all pools and spas
- Easy to configure
- Various attachments
- Wall clip storage



### Hand Held Vacuum Kit

DISCOUNT CODE/ PRODUCT CODE	DESCRIPTION	PRICE EACH
K DSP917	Vacuum Kit	£39.00

ABOVE  
GROUND

## Intex Rechargeable Hand Held Vacuum Kit

- Suitable for use with all PureSpas and above ground pools up to 18' diameter
- Strong built-in rechargeable batteries (50 minutes per charge) for powerful suction capability
- 94" (239cm) lightweight telescopic aluminium pole
- Shaft adapter to fit longer/wider telescopic aluminium poles
- Automatic shut-off feature when vacuum is not submerged
- IPX8 waterproof switch
- USB cable included for convenient recharging



### Intex Rechargeable Hand Held Vacuum Kit

DISCOUNT CODE/ PRODUCT CODE	DESCRIPTION	PRICE EACH
K 28620/E	Rechargeable Hand Held Vacuum	£99.50



## Above Ground LED Light

- Fixes to inlet
- 216 LED's
- Multi-colour RGB
- 11 static colours, 5 colour sequences
- Remote control can operate up to 5 lights
- 12v 16W
- Energy Rating B

### LED Light

DISCOUNT CODE/ PRODUCT CODE	DESCRIPTION	PRICE EACH
K LED005	Above Ground	£198.00
K LED002	RGB Polycarbonate	£284.00

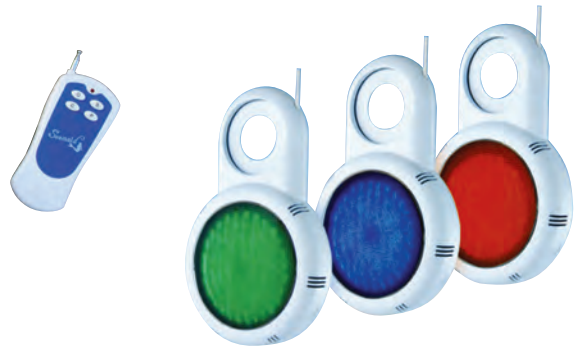

LED005

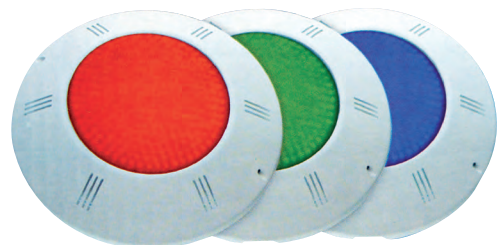

LED002

ABOVE  
GROUND

# Spas & Accessories

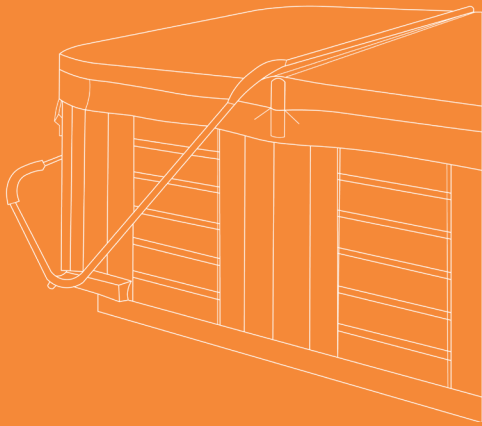

## IQUE® Hot Tubs

HEAVY BULKY



### HOT TUBS UK

After some extensive market research, Plastica are now offering the two best-selling ranges of IQUE® hot tubs, Tonga and Milan - both giving a high quality specification as standard, along with superior comfort. Available with a Balboa® Control panel in a Sterling Silver Aristech® acrylic shell, both globally recognised market leaders in hot tub technology.

- Balboa® TP600 electronic control system
- Aristech® acrylic sheets
- LED colour-changing lighting
- 31 Stainless Steel jets
- Interchangeable jets
- Neck and shoulder massage system
- Heated air blower

Balboa® Control Panel



Triple Thermal Shield Insulation

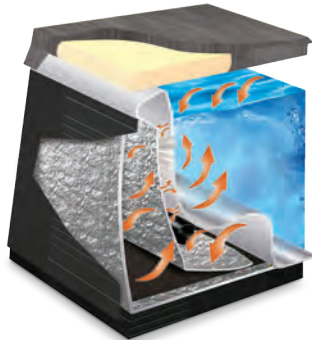

**Note:** Tonga up to 6 people including 1 lounger, 1 king and 1 queen



**Note:** Milan up to 5 people including 2 loungers and 1 king seat.

### IQUE® Hot Tubs

DISCOUNT CODE/ PRODUCT CODE	DESCRIPTION	PRICE EACH
L4 2000-TF-SS	🚚🔺 Tonga 6 people inc. 1 lounger, 1 king & 1 queen seat	£4,000.00
L4 2000-MF-SS	🚚🔺 Milan 5 people inc. 2 loungers & 1 king seat	£4,000.00

Fixed kerbside ONLY delivery charges are allocated zones according to the location in the UK.

### Terms of Sale

IQue Hot Tubs are sold on a proforma basis and must be ordered and paid for using our online portal. Kerbside delivery only. Purchasers will need to arrange Hiab hire and installation of their customer's hot tub. Plastica regrets it cannot offer any form of credit on these products.

Contact [info@iquehottubs.co.uk](mailto:info@iquehottubs.co.uk) to find out more.



**HOT TUBS UK**

# Why buy an IQue hot tub? what you need to know

With the vast array of hot tub models on the market, it's hard to decide which suits you best isn't it?

So we thought we'd help with an upfront, short and sweet summary to explain why IQue Hot Tubs deserve to be checked out further.

## innovation

- Swedish inspired, contemporary, ergonomic and comfortable designs you'll love.
- IQue's energy efficient Triple Thermal Shield Insulation system saves you money on electricity bills.
- Smart, reliable and user friendly Balboa® control panel - the world-renowned hot tub components manufacturer in the US.
- Heated air-blower (as opposed to cold air bubbles) for optimum user comfort.

## quality

- IQue has a first-class reputation and is a leading brand in Scandinavia.
- Every hot tub undergoes rigorous and comprehensive testing.
- Built from Aristech® acrylic sheets - a globally recognised market leader.
- Fitted with contemporary stainless steel jets as standard - you won't need to upgrade from the plastic option.

## unique

- Designed in Sweden; we can't deny the Nordics are experts at this hot tub business can we?
- The Triple Thermal Shield Insulation system and floor-pan will enable you to use your hot tub all year round.
- Unique pre-assembled pipe-manifold and silicone-free plumbing has a resilient leak-free function.
- Rigid ABS Floor pan ensures minimal heat loss and protects the equipment from ground-moisture.

## enjoyment

- Relax and enjoy your therapeutic hot tub hydrotherapy experience, proven to be beneficial to health and well-being.
- Designed for easy access for maintenance.
- Create a stylish ambience with LED colour-changing lighting paired with Sterling Silver acrylic shell.
- Each jet is in a carefully positioned spot to provide the best massage - adjust the direction, intensity and jet action to suit you.



*An intelligent choice  
at competitive prices*

## PureSpa Headrest

- Comfortable headrest
- Fits on top of the spa wall
- Fill with water to weigh down and secure the headrest in place
- Removable for convenience
- 39cm x 30cm x 30cm

### Spa Headrest

DISCOUNT CODE/ PRODUCT CODE	DESCRIPTION	PRICE EACH
L3 28501/E	Spa Headrest	£5.90



28501/E

### Premium Spa Headrest

DISCOUNT CODE/ PRODUCT CODE	DESCRIPTION	PRICE EACH
L3 28505	Premium Spa Headrest	£19.00



28505



## PureSpa Drinks Holder

- Cup holder with refreshment tray
- Holds 2 conventional sized drinks
- Removable for convenience
- 26cm x 22cm x 18cm

### Spa Drinks Holder

DISCOUNT CODE/ PRODUCT CODE	DESCRIPTION	PRICE EACH
L3 28500/E	Spa Drinks Holder	£5.90



28500/E

## PureSpa Booster Seat

- Allows you to sit comfortably in the spa
- Raise a persons height 7.5cm or 15cm
- Removable for convenience
- 47cm x 36cm x 22cm



### PureSpa Seat

DISCOUNT CODE/ PRODUCT CODE	DESCRIPTION	PRICE EACH
L3 28502/E	Spa Booster Seat	£29.60

## PureSpa Maintenance Kit

- Curved brush for inner sidewall care
- Durable mesh skimmer net
- Scrubber pad to help eliminate dirt and grime

### PureSpa Maintenance Kit

DISCOUNT CODE/ PRODUCT CODE	DESCRIPTION	PRICE EACH
L3 28004/E	Spa Maintenance Kit	£13.50



## Intex Rechargeable Hand Held Vacuum Kit

- Suitable for use with all PureSpas and above ground pools up to 18' diameter
- Strong built-in rechargeable batteries (50min per charge) for powerful suction capability
- 94" (239cm) lightweight telescopic aluminium pole
- Shaft adapter to fit longer/wider telescopic aluminium poles
- Automatic shut-off feature when vacuum is not submerged
- IPX8 waterproof switch
- USB cable included for convenient recharging



### Intex Rechargeable Hand Held Vacuum Kit

DISCOUNT CODE/ PRODUCT CODE	DESCRIPTION	PRICE EACH
K 28620/E	Rechargeable Hand Held Vacuum	£99.50



## Hand Held Vacuum Kit

- Suitable for all pools and spas
- Easy to configure
- Various attachments
- Wall clip storage



### Hand Held Vacuum Kit

DISCOUNT CODE/ PRODUCT CODE	DESCRIPTION	PRICE EACH
K DSP917	Vacuum Kit	£39.00

## Pool Drain Pump

- Pumps up to 3595 litres (950 gallons) of water per hour
- Powercord length 7.6m
- Maximum operating depth 1.22m (4ft)
- IPX8 waterproof housing
- Includes 32mm x 5m drain hose
- Adaptor for garden hose attachment
- Shelf box



### Pool Drain Pump

DISCOUNT CODE/ PRODUCT CODE	DESCRIPTION	PRICE EACH
K 28606BS	Pool Drain Pump	£56.00

## Relax Spa Filter Cartridges

### Relax Spa Filter Cartridges

PRODUCT CODE	DESCRIPTION	PRICE EACH
RFINTS1PK2	Inflatable Hot Tub 10.8cm x 7.3cm Pack of 2	£3.15
RFBW6PAIR	Inflatable Hot Tub - 2015 onwards 8cm x 10.6cm Pack of 2	£3.10



# Nazca Wooden Pool Range

## A compact pool solution for the Above or In-Ground market

- Built to last with sustainable materials
- Easy installation
- Great value for money
- Utilises your outdoor space
- Multi-purpose pool - Add a Counter Current to convert to an Exercise Pool!



### 4 x 2m Rectangular Wooden Pool (Includes 4 metal braces)

- External size: 4.5 x 2.5m
- Internal size: 4 x 2m
- Wall height: 1.35m
- Water Level height: 1.22m
- Water Volume: 9,720L

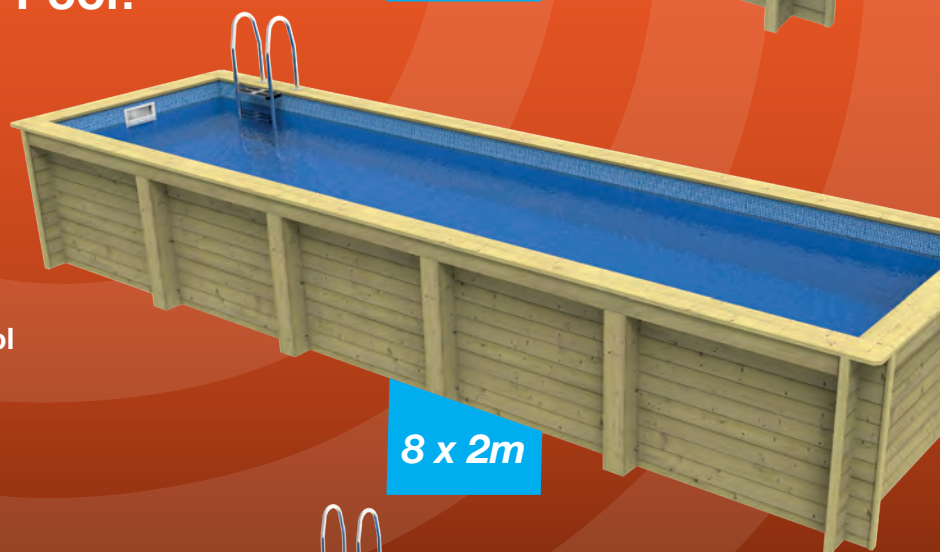

### 8 x 2m Rectangular Wooden Lap Pool (Includes 8 metal braces)

- External size: 8.5 x 2.5m
- Internal size: 8 x 2m
- Wall height: 1.35m
- Water Level height: 1.22m
- Water Volume: 19,440L

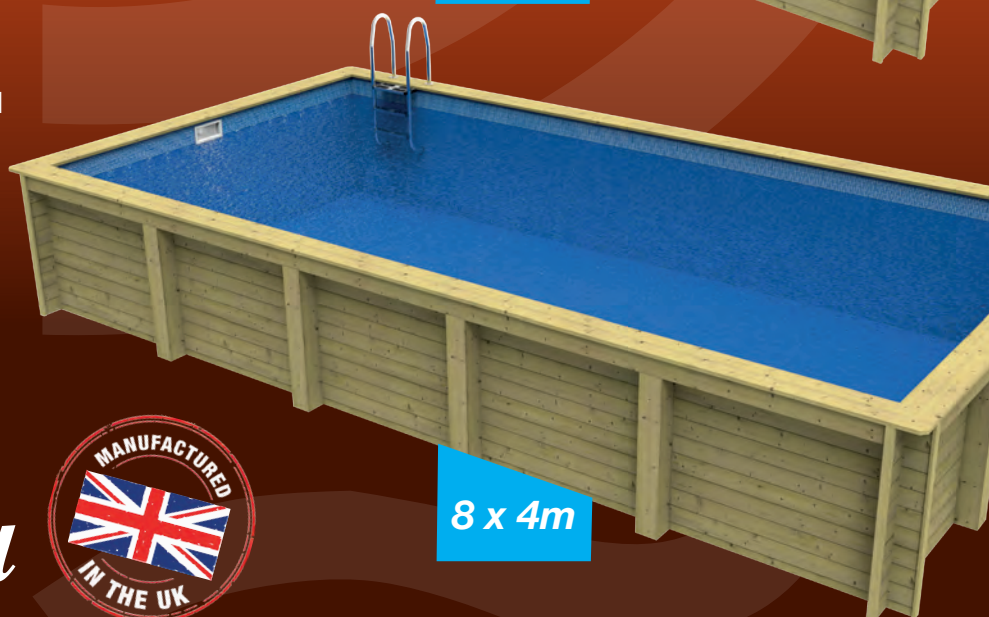

### 8 x 4m Rectangular Wooden Pool (Includes 12 metal braces)

- External size: 8.5 x 4.5m
- Internal size: 8 x 4m
- Wall height: 1.35m
- Water Level height: 1.22m
- Water Volume: 38,880L

 **Plastica**

The UK's Leading Independent  
Swimming Pool Manufacturer and Distributor

☎ 01424 857802 ✉ [orders@plasticapools.net](mailto:orders@plasticapools.net) 🌐 [www.plasticapools.net](http://www.plasticapools.net)



Find us on



## Wooden Spa Step

- Hand crafted by Plastica in the UK
- Natural wood ready to stain or paint on-site
- Supplied flat packed for easy storage and delivery
- High quality timber from a sustainable source (FSC)
- Exceptional value for money

### Wooden Step

DISCOUNT CODE/ PRODUCT CODE	DESCRIPTION	PRICE EACH
F DSP932	Wooden Step	£109.00

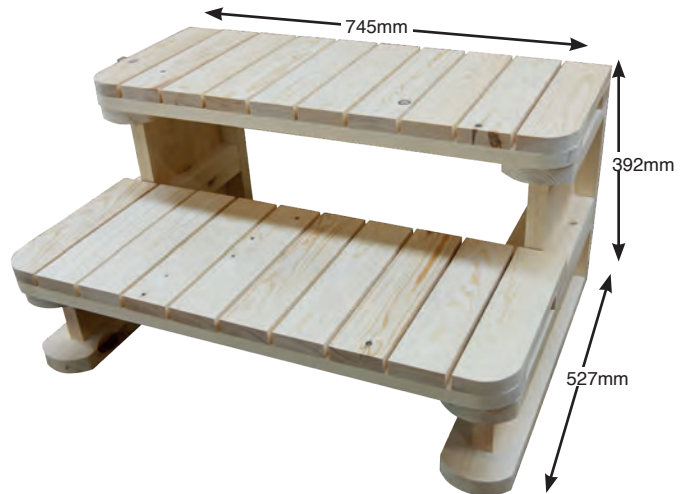

## CoverMate II Spa Cover Lifter with understyle bracket system

These models allow the open cover to rest lower against the spa for a slightly less-obstructed view. Depending on the mounting system, the CoverMate II can be screw-mounted low on the spa, or simply slid underneath for spas with weaker skirts using the optional Understyle bracket system.

### CoverMate II Spa Cover Lifter

DISCOUNT CODE/ PRODUCT CODE	DESCRIPTION	PRICE EACH
F CMII-US	Covermate II with understyle bracket	£185.00

- Requires just 18 inches of clearance behind spa
- Powder-coated, aluminum tubing with easy-to-install, non-corrosive mounting brackets
- Understyle system uses two aluminum brackets and 7-inch base plates that simply slide under the spa



## Spa Cover Safety Catch

### Spa Cover Safety Catch

DISCOUNT CODE/ PRODUCT CODE	DESCRIPTION	PRICE EACH
S SSC001P4	Spa Cover Safety Catch, pack of 4	£21.00





## Spa Cover Protectors

Our Spa Cover Protector will extend the life of your Rigid Cover by acting as a barrier against the harmful effects of the spa water vapour.

- UV stabilised
- 400 micron
- Opaque blue top and black underside
- Eliminates water evaporation by 98%
- Eliminates heat loss
- Reduces chemical and energy consumption

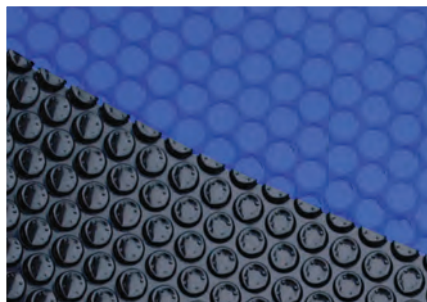

### Spa Cover Protectors

DISCOUNT CODE/ PRODUCT CODE	DESCRIPTION	PRICE EACH
NETT PSO100	2m x 2m Blue Black Opaque Cover Protector	£9.95
NETT PSO100-10	2m x 2m Blue Black Opaque Cover Protector, pack of 10	£90.00

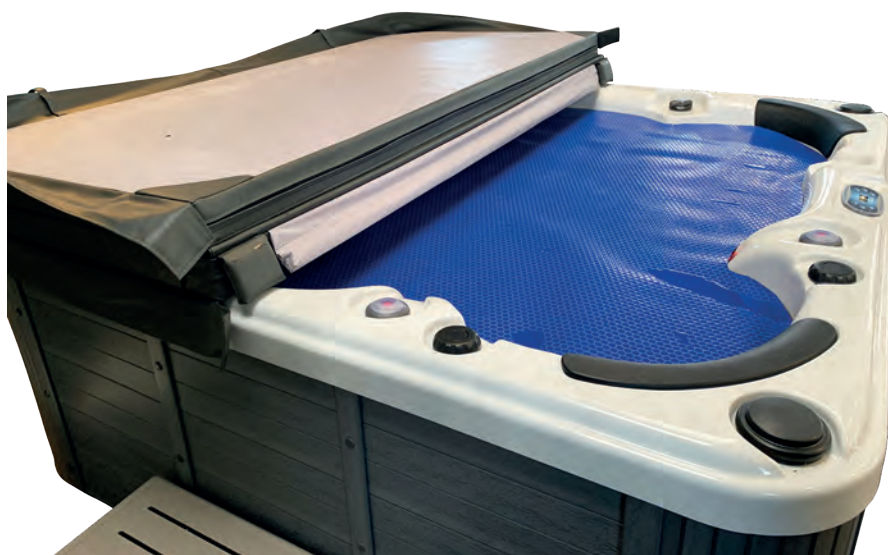

## INTEX MULTI-COLOURLED LED BUBBLE SPA LIGHT

- Create the perfect mood while you relax
- Up to 5 different colours
- 2-hour auto shut off
- Requires 3 x AAA batteries
- 2 lighting modes, single or colour changing

### Multi-Coloured LED Bubble Spa Light

DISCOUNT CODE/ PRODUCT CODE	DESCRIPTION	PRICE EACH
L3 28503E	Multi-coloured LED Light for Bubble Spa	£24.00

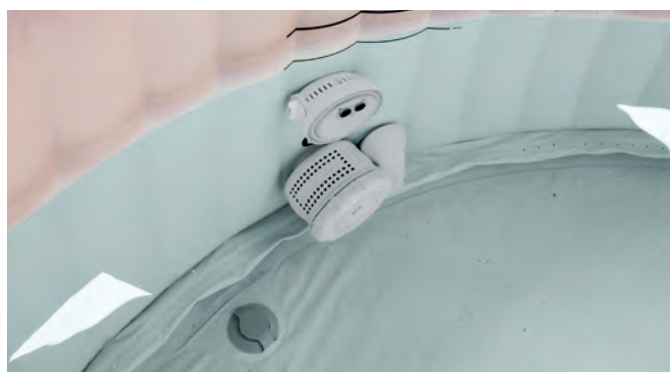

SPAS &  
ACCESSORIES

## Relax Premium 9 Part Spa Starter Kit

### Relax Premium 9 Part Spa Starter Kit

DISCOUNT CODE/ PRODUCT CODE	DESCRIPTION	PRICE EACH
T5 RSPAKIT1	Relax Spa Starter Kit Stabilised Chlorine Granules (box of 4)	£148.00
T5 RSPAKIT3	Relax Spa Starter Kit Brominating Granules (box of 4)	£190.00

- 500g Stabilised Chlorine Granules or Brominating Granules
- 30g Energize sachet
- 500g pH Plus
- 750g pH Minus
- 500ml No Foam
- 500ml Filter Cleaner
- Spa test strips
- Spa care booklet



## Relax Essential Spa Kit

- 500g Stabilised Chlorine Granules
- 30g Energize sachet
- 500g pH Plus
- 750g pH Minus
- 500ml No Foam
- Spa test strips
- Spa care booklet
- Measuring spoons



### Relax Essential Spa Kit

DISCOUNT CODE/ PRODUCT CODE	DESCRIPTION	PRICE EACH
T5 RSPAKIT8	Relax Essential Spa Kit (box of 4)	£116.00

## Relax Speciality Spa Products

### Relax Spa Water Treatment

DISCOUNT CODE/ PRODUCT CODE	DESCRIPTION	PRICE EACH
T4 RSPA30	Box of 6 x 0.5 Litre Clarifier	£21.00
T4 RSPA29	Box of 6 x 1 Litre Clarifier	£30.00
T4 RSPA28	Box of 6 x 0.5 Litre No-Foam	£30.00
T4 RSPA27	Box of 6 x 1 Litre No-Foam	£48.00
T4 RSPA31	Box of 6 x 0.5 Litre Stain & Scale Inhibitor	£42.00
T4 RSPA34	Box of 6 x 500ml Cartridge Filter Cleaner Instant Spray	£42.00
T4 RSPA25	Box of 6 x 0.5 Litre Cartridge Filter Cleaner Soak	£27.00
T4 RSPA24	Box of 6 x 1 Litre Cartridge Filter Cleaner Soak	£39.00
T4 RSPA32	Box of 6 x 0.5 Litre Hot Tub Flush	£60.00
T4 RSPA33	Box of 6 x 500ml Vinyl Cover Cleaner & Preserver Spray	£84.00



**i** Please see our Water Treatment section for our full range of spa care products from page 224-227

## Relax Spa Filter Cartridges

- Cartridges available to fit PureSpa
- Suitable for acrylic spas
- Quality filtration at economy prices
- Dosing pod options for 20g Chlorine or Bromine tablets
- Inline dosing complies with Section 76, HSG282



RFINTS1PK2



RFPOD



RFWW50P3

If you need assistance ordering the correct size cartridge, please contact our Customer Services team on 01424 857802 or your Sales Representative.

PRODUCT CODE	DESCRIPTION	Diameter	Length	Top	Bottom	Material Area	PRICE EACH
RFA50	Hayward, Cal Spas, Vita Spas 50 sq ft - 17.8cm x 50.2cm	7in 178mm	19 3/4in 502mm	3in 76mm	3in 66mm	50sq ft	£18.45
RFAS40F2M	Artesian Spas 40 sq ft - 15.2cm x 19.4cm	6in 152mm	7 5/8in in 194mm	Handle/ Removable Lid	2in MPT	40 sq ft	£16.90
RFAS40F2M-POD	Artesian Spas 40 sq ft - 15.2cm x 19.4cm + pod *	6in 152mm	7 5/8in in 194mm	Handle/ Removable Lid	2in MPT	40 sq ft	£19.90
RFAS50SVF2M	Artesian Spas 50 sq ft - 17.1cm x 20.3cm	6 3/4 in 171mm	8in 203mm	Handle/ Removable Lid	2in MPT	50 sq ft	£19.75
RFAS50SVF2M-POD	Artesian Spas 50 sq ft - 17.1cm x 20.3cm + pod *	6 3/4 in 171mm	8in 203mm	Handle/ Removable Lid	2in MPT	50 sq ft	£22.75
RFAST75	Cartridge Filters 75sq ft - 22.7cm x 38.1cm	8 15/16in 227mm	15in 381mm	3 3/4in 95mm	3 3/4in 95mm	75 sq ft	£44.85
RFBF35M	Various Hot Tubs 35 sq ft - 20.3cm x 14.9cm	8in 203mm	5 7/8in 149mm	Handle	2in modified ACME	35 sq ft	£19.20
RFBW3PAIR	Cartridge Filter Pump Units 4 sq ft - 7.9cm x 9cm - pack of 2	3 1/8in 79mm	3 9/16in 90mm	1 3/16in 30mm	1 3/16in 30mm	4 sq ft	£3.55
RFBW4PAIR	Cartridge Filter Pump Units 6 sq ft - 10.8cm x 9.5cm - pack of 2	4 1/4in 108mm	3 3/4in 95mm	2 1/16in 52mm	2 1/16in 52mm	6 sq ft	£3.90
RFBW5PAIR	Cartridge Filter Pump Units 8 sq ft - 10.8cm x 13.8cm - pack of 2	4 1/4in 108mm	5 7/16in 138mm	2 1/16in 52mm	2 1/16in 52mm	8 sq ft	£5.00
RFBW6PAIR	Inflatable Hot Tubs - 2015 onwards - 8cm x 10.6cm - pack of 2	4 11/16in 106mm	3 5/31in 80mm	1 31/32in 50mm	1 31/32in 50mm	3 sq ft	£3.10
RFCAL60F2M	Cal Spas 60sq ft - 13.2cm x 40.6cm	5 3/16in 132mm	16in 406mm	Handle	2in MPT	60 sq ft	£25.00
RFCD75N	Caldera Spas 75 sq ft - 17.8cm x 37.8cm	7in 178mm	14 7/8in 378mm	Handle	2 11/16in	75 sq ft	£26.50
RFCH75	Christal Pools 75 sq ft - 13.3cm x 61.3cm	5 1/4in 133mm	24 1/8in 613mm	Closed	5 3/16in Slip	75 sq ft	£54.00
RFFF42TCP4	Freeflow Spas 2013 onwards 42 sq ft - 13.3cm x 23.8cm	5 1/4in 133mm	9 3/8in 238mm	Closed	1 1/2in MPT	42 sq ft	£14.35
RFFF50P4	Freeflow Spas Legend 50 sq ft - 13.5cm x 25.4cm	5 5/16in 135mm	10in 254mm	2 1/8in	1 1/2 MPT	50 sq ft	£13.30
RFH6	Various Hot Tubs 6 sq ft - 7cm x 24.8cm	2 3/4in 70mm	9 3/4in 248mm	1 1/16in 27mm	1 1/16in 27mm	6 sq ft	£4.20
RFIN3PAIR	Cartridge Filter Pump Units 3 sq ft - 7.8cm x 9.4cm	3 1/16in 78mm	3 11/16in 94mm	1 1/16in 27mm	1 1/16in 27mm	3 sq ft	£3.85
RFINFSPAPK2	Inflatable Hot Tubs with thread - 10cm x 8cm	3 15/16in 100mm	3 5/32in 80mm	Closed	Thread	3 sq ft	£5.90
RFINTA	Cartridge Filter Pump Units - 10.8cm x 20.3cm	4 1/4in 108mm	8 1/8in 206mm	2in 51mm	2in 51mm	5 sq ft	£2.90
RFINTAPK2	Cartridge Filter Pump Units - 10.8cm x 20.3cm - pack of 2	4 1/4in 108mm	8 1/8in 206mm	2in 51mm	2in 51mm	5 sq ft	£5.70
RFINTS1PK2	Inflatable Hot Tubs - 10.8cm x 7.3cm	4 1/4in 108mm	3in 73mm	1 5/8in 41mm	1 5/8in 41mm	3 sq ft	£3.15
RFJ25IN	Jacuzzi 25 sq ft - 12.7cm x 33.7cm	5in 127mm	13 1/4in 337mm	2 3/8in 60mm	2 3/8in 60mm	25 sq ft	£9.90
RFJ100	Jacuzzi 100 sq ft - 25.4cm x 50.6cm	10in 254mm	19 7/8in 505mm	5 15/16in 152mm	6in	100 sq ft	£43.90
RFJ400	Jacuzzi J-400 series Pre 2012 60sq ft - 12cm x 31.8cm with handle - removable lid	4 23/32in 120mm	12 33/64in 318mm	Handle/ Removable Lid	2in SAE	60 sq ft	£17.95
RFJ400-POD	Jacuzzi J-400 series Pre 2012 60sq ft - 12cm x 31.8cm with handle - removable lid + pod *	4 23/32in 120mm	12 33/64in 318mm	Handle/ Removable Lid	2in SAE	60 sq ft	£20.95
RFJ60	Jacuzzi J-300, J-400 series 60sq ft - 15.2cm x 44.5cm with handle - removable lid	5 63/64in 152mm	17 33/64in 445mm	Handle/ Removable Lid	2in SAE	60 sq ft	£22.90
RFJ60-POD	Jacuzzi J-300, J-400 series 60sq ft - 15.2cm x 44.5cm with handle - removable lid + pod *	5 63/64in 152mm	17 33/64in 445mm	Handle/ Removable Lid	2in SAE	60 sq ft	£25.90
RFJZ16F2L	Jazzi and Passion Spas 17 sq ft - 14.3cm x 17.3cm	5 5/8in 143mm	6 13/16in 173mm	Closed	2in MPT	17 sq ft	£14.50
RFMA10M	Master Spas Eco-pur replacement - 9.8cm x 18.1cm	3 7/8in 98mm	7 1/8in 181mm	2 1/8in 54mm	2 1/8in 54mm	10 sq ft	£6.80
RFMA20F2M	Master Spas 20 sq ft - 12.1cm x 20.5cm with handle - removable lid	4 3/16in 121mm	8 1/16in 205mm	Handle/ Removable Lid	2in MPT	20 sq ft	£12.30

SPAS & ACCESSORIES

## Relax Spa Filter Cartridges

PRODUCT CODE	DESCRIPTION	Diameter	Length	Top	Bottom	Material Area	PRICE EACH
RFMA20F2M-POD	Master Spas 20 sq ft - 12.1cm x 20.5cm with handle - removable lid + pod *	4 3/8in 121mm	8 1/16in 205mm	Handle/ Removable Lid	2in MPT	20 sq ft	£15.30
RFMA40LF2M	Master Spas 40 sq ft - 15.2cm x 23.5cm	6in 152mm	9 1/4in 235mm	Handle	2in MPT	40 sq ft	£15.85
RFMA452004R	Master Spas 45 sq ft - 21cm x 17.5cm	8 1/4in 210mm	6 7/8in 175mm	4 1/16in 103mm	4 1/16in 103mm	45 sq ft	£15.90
RFMAX50P3	iQue Hot Tubs, Artesian Spas, Elite Spase 50 sq ft - 14.6cm x 20.3cm	5 3/4in 146mm	8in 203mm	Handle	1 1/2in SAE	50 sq ft	£18.15
RFMAX50P3M	iQue Hot Tubs, Artesian Spas, Elite Spase 50 sq ft - 14.6cm x 20.3cm - Antimicrobial	5 3/4in 146mm	8in 203mm	Handle	1 1/2in SAE	50 sq ft	£20.15
RFMAX50P4	Various Hot Tubs 50 sq ft - 14.6cm x 20.3cm	5 3/4in 146mm	8in 203mm	Handle	1 1/2in SAE	50 sq ft	£18.15
RFMCCY40	Multi Cyclone 40sq ft Pre-Filter - 16cm x 19.7cm	6 19/64in 160mm	7 3/4in 197mm	2 3/32in /53mm	2 3/32in /53mm	40 sq ft	£15.60
RFRB25IN	Various Hot Tubs 25sq ft - 12.7cm x 33.8cm - with internal block to support pod	5in 127mm	13 5/16in 338mm	2 1/8in 54mm	2 1/8in 54mm	25 sq ft	£11.65
RFRB25IN-POD	Various Hot Tubs 25sq ft - 12.7cm x 33.8cm - with internal block to support pod + pod *	5in 127mm	13 5/16in 338mm	2 1/8in 54mm	2 1/8in 54mm	25 sq ft	£14.65
RFRB25INM	Various Hot Tubs 25sq ft - 12.7cm x 33.8cm - Antimicrobial with internal block to support pod	5in 127mm	13 5/16in 338mm	2 1/8in 54mm	2 1/8in 54mm	25 sq ft	£13.65
RFRB25INM-POD	Various Hot Tubs 25sq ft - 12.7cm x 33.8cm - Antimicrobial with internal block to support pod + pod *	5in 127mm	13 5/16in 338mm	2 1/8in 54mm	2 1/8in 54mm	25 sq ft	£16.65
RFRB35IN	Various Hot Tubs 35 sq ft - 12.7cm x 23.5 - with internal block to support pod	5in 127mm	9 1/4in 235mm	2 1/8in 54mm	2 1/8in 54mm	35 sq ft	£12.45
RFRB35IN-POD	Various Hot Tubs 35 sq ft - 12.7cm x 23.5 - with internal block to support pod + pod *	5in 127mm	9 1/4in 235mm	2 1/8in 54mm	2 1/8in 54mm	35 sq ft	£15.45
RFRB35INM	Various Hot Tubs 35 sq ft - 12.7cm x 23.5 - Antimicrobial with internal block to support pod	5in 127mm	9 1/4in 235mm	2 1/8in 54mm	2 1/8in 54mm	35 sq ft	£14.45
RFRB35INM-POD	Various Hot Tubs 35 sq ft - 12.7cm x 23.5 - Antimicrobial with internal block to support pod + pod *	5in 127mm	9 1/4in 235mm	2 1/8in 54mm	2 1/8in 54mm	35 sq ft	£17.45
RFRB50IN	Various Hot Tubs 50sq ft - 12.7cm x 33.8cm - with internal block to support pod	5in 127mm	13 5/16in 338mm	2 1/8in 54mm	2 1/8in 54mm	50 sq ft	£14.95
RFRB50IN-POD	Various Hot Tubs 50sq ft - 12.7cm x 33.8cm - with internal block to support pod + pod *	5in 127mm	13 5/16in 338mm	2 1/8in 54mm	2 1/8in 54mm	50 sq ft	£17.95
RFRB50INM	Various Hot Tubs 50sq ft - 12.7cm x 33.8cm - Antimicrobial with internal block to support pod	5in 127mm	13 5/16in 338mm	2 1/8in 54mm	2 1/8in 54mm	50 sq ft	£17.10
RFRB50INM-POD	Various Hot Tubs 50sq ft - 12.7cm x 33.8cm - Antimicrobial with internal block to support pod + pod *	5in 127mm	13 5/16in 338mm	2 1/8in 54mm	2 1/8in 54mm	50 sq ft	£20.10
RFRB75	Various Hot Tubs 75 sq ft - 12.7cm x 51.1cm	5in 127mm	20 1/8in 511mm	2 1/8in 54mm	2 1/8in 54mm	75 sq ft	£19.25
RFRB75M	Various Hot Tubs 75 sq ft - Antimicrobial 12.7cm x 51.1cm	5in 127mm	20 1/8in 511mm	2 1/8in 54mm	2 1/8in 54mm	75 sq ft	£21.25
RFSANT20P3	Various Hot Tubs 20 sq ft - 12.1cm x 17.9cm with handle - removable lid	4 3/4in 121mm	7 1/16in 179mm	Handle/ Removable Lid	1 1/2in SAE	20 sq ft	£10.45
RFSANT20P3-POD	Various Hot Tubs 20 sq ft - 12.1cm x 17.9cm with handle - removable lid + pod *	4 3/4in 121mm	7 1/16in 179mm	Handle/Re- movable Lid	1 1/2in SAE	20 sq ft	£13.45
RFWK30	Hot Springs 30 sq ft - 14.9cm x 26.7cm - with internal block to support pod	5 7/8in 149mm	10 1/2in 267mm	1 15/16in 49mm	1 15/16in 49mm	30 sq ft	£15.00
RFWK30-POD	Hot Springs 30 sq ft - 14.9cm x 26.7cm - with internal block to support pod + pod *	5 7/8in 149mm	10 1/2in 267mm	1 15/16in 49mm	1 15/16in 49mm	30 sq ft	£18.00
RFWK65	Hot Springs 65 sq ft - 21.6cm x 26.7cm	8 1/2in 216mm	10 1/2in 267mm	3in 76mm	3in 76mm	65 sq ft	£23.70
RFWW35L	Various Hot Tubs 35 sq ft - 12.7cm x 21.6cm with handle - removable lid	5in 127mm	8 1/2in 216mm	Handle/ Removable Lid	1 1/2in Female SAE	35 sq ft	£11.00
RFWW35L-POD	Various Hot Tubs 35 sq ft - 12.7cm x 21.6cm with handle - removable lid + pod *	5in 127mm	8 1/2in 216mm	Handle/ Removable Lid	1 1/2in Female SAE	35 sq ft	£14.00
RFWW50L	Various Hot Tubs 50 sq ft - 12.7cm x 33.5cm with handle - removable lid	5in 127mm	13 3/16in 335mm	Handle/ Removable Lid	1 1/2in Female SAE	50 sq ft	£12.85
RFWW50L-POD	Various Hot Tubs 50 sq ft - 12.7cm x 33.5cm with handle - removable lid + pod *	5in 127mm	13 3/16in 335mm	Handle/ Removable Lid	1 1/2in Female SAE	50 sq ft	£15.85
RFWW50P3	Various Hot Tubs 50 sq ft - 15.2cm x 19.4cm with handle - remoavable lid	6in 152mm	7 5/8in 194mm	Handle/ Removable Lid	1 1/2in Female SAE	50 sq ft	£11.45
RFWW50P3-POD	Various Hot Tubs 50 sq ft - 15.2cm x 19.4cm with handle - remoavable lid + pod *	6in 152mm	7 5/8in 194mm	Handle/ Removable Lid	1 1/2in Female SAE	50 sq ft	£14.45
RFWW50P3M	Various Hot Tubs 50 sq ft - 15.2cm x 19.4cm with handle - Antimicrobial removable lid	6in 152mm	7 5/8in 194mm	Handle/ Removable Lid	1 1/2in Female SAE	50 sq ft	£13.45
RFWW50P3M-POD	Various Hot Tubs 50 sq ft - 15.2cm x 19.4cm with handle - Antimicrobial removable lid + pod *	6in 152mm	7 5/8in 194mm	Handle/ Removable Lid	1 1/2in Female SAE	50 sq ft	£16.45
RFWW50P4	Various Hot Tubs 50 sq ft - 15.2cm x 19.4cm with handle - removable lid	6in 152mm	7 5/8in 194mm	Handle/ Removable Lid	1 1/2in Female SAE	50 sq ft	£11.45
RFWW50P4-POD	Various Hot Tubs 50 sq ft - 15.2cm x 19.4cm with handle - removable lid + pod *	6in 152mm	7 5/8in 194mm	Handle/ Removable Lid	1 1/2in Female SAE	50 sq ft	£14.45
RFWW100STP3	Waterways Stack 100 sq ft - removable lid	6in 152mm	16 1/2in 419mm	Handle/ Removable Lid	1 1/2in Female SAE	100 sq ft	£31.55
RFWW-100STP3-POD	Waterways Stack 100 sq ft - removable lid + pod *	6in 152mm	16 1/2in 419mm			100 sq ft	£34.55
RFPOD	Inline Dosing Pod to fit compatible Relax Spa filter cartridges						£3.50

SPAS & ACCESSORIES

Prices for Box, Quarter, Half & Full Pallet Quantities are available on our Website

# Inflatables & Games

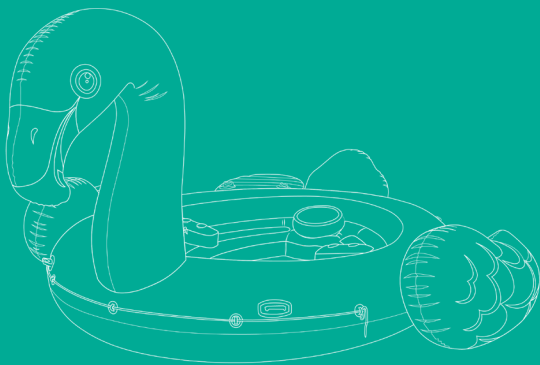

## Padding Pools

### Padding Pools

DISCOUNT CODE/ PRODUCT CODE	DESCRIPTION	PRICE EACH
L 56441NP	☀️ Sunset Glow Pool (1680 x 460mm)	£21.50



Sunset Glow – 56441NP

## Padding Pool Cover

### Padding Pool Cover

DISCOUNT CODE/ PRODUCT CODE	DESCRIPTION	PRICE EACH
L 58412NP	☀️ Swim Centre Rectangular Cover (3050 x 1830mm)	£10.00



Swim Centre Rectangular Cover – 58412NP

## Relax Kiddy Pool Care Paddling Pool Treatment

- Chlorine-free treatment for unfiltered pools
- Keeps water clean and healthy for up to 2 weeks
- Acts as an algicide and bactericide
- Treats up to 1000 litre paddling pools



### Relax Kiddy Pool Care Paddling Pool Treatment Sachets

DISCOUNT CODE/ PRODUCT CODE	DESCRIPTION	PRICE EACH
T19 PCH850	☀️ Box of 20 sachets	£70.00

## Inflatable Loungers

### Loungers

DISCOUNT CODE/ PRODUCT CODE	DESCRIPTION	PRICE EACH
L 58868EU	☀️ Floating Recliner Lounger (1800 x 1350mm)	£45.50



Floating Recliner Lounger – 58868EU

**ALL INFLATABLES ARE FOR SWIMMING POOL USE ONLY**

## Inflatable Novelties

- Realistic printed design
- Made from 0.30mm vinyl
- Repair patch
- Shelf box
- Easy inflation and deflation for storage and transport

### Inflatable Novelties

DISCOUNT CODE/ PRODUCT CODE	DESCRIPTION	PRICE EACH
L 58753EU	Lollipop Float (2080 x 1350mm)	£22.00
L 58781EU	Strawberry Island (1680 x 1420mm)	£26.00
L 57281EU	Mega Unicorn Island (2870 x 1930 x 1650mm)	£28.00



Lollipop Float - 58753EU



Strawberry Island - 58781EU



Mega Unicorn Island - 57281EU

ALL INFLATABLES ARE FOR SWIMMING POOL USE ONLY

# Inflatable Novelties

- Realistic printed design
- Made from 0.35mm vinyl
- Repair patch
- Shelf box
- Great for riding, playing and lounging

## Inflatable Novelties

DISCOUNT CODE/ PRODUCT CODE	DESCRIPTION	PRICE EACH
L 56288EU	Mega Flamingo Island (2180 x 2110 x 1360mm)	£29.00
L 58766EU	Cool Me Down Popsicle Float (1910 x 760mm)	£11.00
L 56283EU	Water Melon Island (1750 x 1450mm)	£32.00
L 58752EU	Pizza Slice Mat (1750 x 1450mm)	£22.60



Max 200kg 14+

Mega Flamingo Island- 56288EU



Max 100kg 14+

Cool Me Down Popsicle Float - 58766EU



Max 200kg 14+

Watermelon Island - 56283EU



Max 100kg 14+

Pizza Slice Mat - 58752EU

INFLATABLES & GAMES

ALL INFLATABLES ARE FOR SWIMMING POOL USE ONLY

## Inflatable Loungers



18 Pocket Lounger – 59895EU



Max 200kg 14+

Double Fun Two Person Lounger – 56897EU



Max 100kg 14+

Pillow Back – 58889EU

### Inflatable Loungers

DISCOUNT CODE/ PRODUCT CODE	DESCRIPTION	PRICE EACH
L 58889EU	🌀 Pillow Back Lounger (1370 x 1220mm) two colours	£11.60
L 59895EU	🌀 18 Pocket Lounger (1880 x 710mm) two colours	£11.70
L 56897EU	🌀 Double Fun Two Person Lounger (1980 x 1600mm)	£46.00

## Ride-On Inflatables



Max 40kg 3+

Lil' Gator Ride-On – 58546NP



Max 40kg 3+

Stingray Ride-On – 57550NP

ALL INFLATABLES ARE FOR SWIMMING POOL USE ONLY

# Ride-On Inflatables



Whale – 58561NP



Realistic Whale Ride-On – 57530NP/EP



Giant Gator – 58562NP



Lil' Sea Turtle Ride-On – 57524NP

## Ride-On Inflatables

DISCOUNT CODE/ PRODUCT CODE	DESCRIPTION	PRICE EACH
L 57550NP	⊛ Stingray Ride-on age 3+ (1880 x 1450mm)	£18.80
L 58546NP	⊛ Lil' Gator Ride-on age 3+ (1680 x 860mm)	£12.00
L 58561NP	⊛ Whale (1930 x 1190mm)	£17.00
L 57530NP/EP	⊛ Realistic Whale age 3+ (2001 x 1350mm)	£22.00
L 58562NP	⊛ Giant Gator (2030 x 1140mm)	£18.00
L 57524NP	⊛ Lil' Sea Turtle (1500 x 1270mm)	£13.20

INFLATABLES  
& GAMES

ALL INFLATABLES ARE FOR SWIMMING POOL USE ONLY

## Inflatable Tubes



Max 100kg 14+

Sit 'n' Lounge – 58883NP



Max 100kg 14+

Sit 'n' Float – 58859EU



Max 100kg 9+

Whirl Tube – 58202EU

### Tubes

DISCOUNT CODE/ PRODUCT CODE	DESCRIPTION	PRICE EACH
L 58883NP	⊕ Sit 'n' Lounge (1190mm)	£18.10
L 58859EU	⊕ Sit 'n' Float (1520 x 950mm)	£13.20
L 58202EU	⊕ Whirl Tube (1190mm)	£15.00

## Water Slide

### Water Slide

DISCOUNT CODE/ PRODUCT CODE	DESCRIPTION	PRICE EACH
L 58849NP/EP	⊕ Water Slide L333 x D206 x H117cm	£159.00



Max 80kg 6+



ALL INFLATABLES ARE FOR SWIMMING POOL USE ONLY

## Inflatable Games



Pool Volleyball Game – 56508NP



Floating Hoop – 58504NP



Fun Goals Game – 58507NP

### Inflatable Games

DISCOUNT CODE/ PRODUCT CODE	DESCRIPTION	PRICE EACH
L 56508NP	Pool Volleyball Game	£17.90
L 58504NP	Floating Hoop	£9.20

### Goal Games

DISCOUNT CODE/ PRODUCT CODE	DESCRIPTION	PRICE EACH
L 58507NP	Fun Goals Game (55" x 35" x 32")	£22.00

## Pumps & Patches

### Pumps

DISCOUNT CODE/ PRODUCT CODE	DESCRIPTION	PRICE EACH
L 68610	Giant Bellows Foot Pump	£11.60
L 68609BS	Quick Fill (220 - 240v)	£44.00

**Note:** Plugs into cigarette lighter or household electrical socket.



Giant Bellows Foot Pump – 68610



Quick Fill – 68609BS

### Inflatable Repair

DISCOUNT CODE/ PRODUCT CODE	DESCRIPTION	PRICE EACH
B 59631NP	6x Repair Patches	£2.50



Repair Patches – 59631NP

## Dive Toys



Play Sticks – 55504



Underwater Fish Rings – 55507



### Dive Toys

DISCOUNT CODE/ PRODUCT CODE	DESCRIPTION	PRICE EACH
L 55507	Underwater Fish Rings (pack of 4)	£7.00
L 55504	Underwater Play Sticks (pack of 5)	£7.00
L 55503	Underwater Fun Balls (pack of 3)	£7.00



Fun Balls – 55503



Play Sticks – 55504

## Floats & Swimming Aids

### Floats & Swimming Aids

DISCOUNT CODE/ PRODUCT CODE	DESCRIPTION	PRICE EACH
K FSR001	Foam Ring (440mm Internal Diameter)	£20.50
K SWR001	Swim Ring (270mm Internal Diameter)	£24.00



Swim Ring – SWR001



Foam Ring – FSR001

## Mega Chill Cup Holder

- 5 built-in cup holders and 2 trays
- 0.4mm thick vinyl
- 2 durable handles
- 3 air chambers
- Comes in display box with repair patch



### Mega Chill

DISCOUNT CODE/ PRODUCT CODE	DESCRIPTION	PRICE EACH
L 56822NP/EP	Mega Chill (890mm)	£21.00

## Water Logs

BULKY

- 1.59m long x 6cm diameter
- Six colours
- Connectors allow you to create a variety of shapes

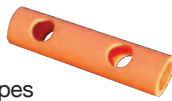

### Water Logs

DISCOUNT CODE/ PRODUCT CODE	DESCRIPTION	PRICE EACH
L6 GAP240	Water Logs Box of 50*	£268.00
L6 GAP239	Water Logs Box of 24	£127.00

### Foam Connectors

DISCOUNT CODE/ PRODUCT CODE	DESCRIPTION	PRICE EACH
L6 GAP255	Medium Links 220mm (1 hole)	£4.80
L6 GAP260	Large Links 330mm (2 holes)	£6.50



INFLATABLES  
& GAMES

ALL INFLATABLES ARE FOR SWIMMING POOL USE ONLY

# Water Treatment



## Relax® Spa Water Treatment Range



The Relax® range of Spa Water Treatment products has proven to be very popular. Over the last 5 years we have had great feedback from our dealers, on the clarity of the back label information, useful dosing charts, step-by-step instructions and quick reference pictograms. The range has been created with eye catching, contemporary branding and innovative products.

The range is available with a point-of-sale display stands that will enhance any professional showroom and ensure maximum exposure of 'impulse sale' speciality products. All this at highly competitive prices.

Contact Customer Services to order yours!

Email: [orders@plasticapools.net](mailto:orders@plasticapools.net)

Tel: 01424 857802



## Relax® Spa Water Treatment Range

### Relax® Spa Chlorine Sanitisers

DISCOUNT CODE/ PRODUCT CODE	DESCRIPTION	SINGLE PRICE	BOX PRICE
T8 RSPA02	Box of 6 x 500g Stabilised Chlorine Granules	£7.00	£42.00
T8 RSPA01	Box of 6 x 1kg Stabilised Chlorine Granules	£12.00	£72.00
T8 RSPA06	Box of 6 x 500g Chlorine Tablets (20g)	£8.75	£52.50
T8 RSPA05	Box of 6 x 1kg Chlorine Tablets (20g)	£13.00	£78.00
T8 RSPA04	Box of 6 x 500g Multifunction Chlorine Tablets (20g)	£10.00	£60.00
T8 RSPA03	Box of 6 x 1kg Multifunction Chlorine Tablets (20g)	£17.00	£102.00
T18 RSPA10	Box of 6 x 500g Shock Chlorine Granules	£9.00	£54.00
T18 RSPA09	Box of 6 x 1kg Shock Chlorine Granules	£16.00	£96.00



### Relax® Spa Bromine Sanitisers

DISCOUNT CODE/ PRODUCT CODE	DESCRIPTION	SINGLE PRICE	BOX PRICE
T7 RSPA08	Box of 6 x 500g Bromine Tablets	£15.00	£90.00
T7 RSPA07	Box of 6 x 1kg Bromine Tablets	£26.00	£156.00
T7 RSPA12	Box of 6 x 500g Brominating Granules	£12.50	£75.00
T7 RSPA11	Box of 6 x 1kg Brominating Granules	£21.00	£126.00
T6 RSPA26	Box of 6 x 2kg Bromine Salt	£25.33	£152.00



### Relax® Spa Oxygen Shock

DISCOUNT CODE/ PRODUCT CODE	DESCRIPTION	SINGLE PRICE	BOX PRICE
T9 RSPA23	Box of 6 x 500g Oxy-Shock	£11.00	£66.00
T9 RSPA22	Box of 6 x 1kg Oxy-Shock	£20.00	£120.00



### Relax® Spa Water Balance

DISCOUNT CODE/ PRODUCT CODE	DESCRIPTION	SINGLE PRICE	BOX PRICE
T9 RSPA16	Box of 6 x 750g pH Minus	£4.50	£27.00
T9 RSPA15	Box of 6 x 1.5kg pH Minus	£6.00	£36.00
T9 RSPA14	Box of 6 x 500g pH Plus	£4.75	£28.50
T9 RSPA13	Box of 6 x 1kg pH Plus	£5.50	£33.00
T9 RSPA18	Box of 6 x 500g T.A. Plus	£4.50	£27.00
T9 RSPA17	Box of 6 x 1kg T.A. Plus	£5.50	£33.00
T9 RSPA20	Box of 6 x 500g Hardness Plus	£5.50	£33.00
T9 RSPA19	Box of 6 x 1kg Hardness Plus	£8.00	£48.00



## Relax® Spa Water Treatment Range

### Relax® Spa Cleaners

DISCOUNT CODE/ PRODUCT CODE	DESCRIPTION	SINGLE PRICE	BOX PRICE
T4 RSPA34	Box of 6 x 500ml Cartridge Filter Cleaner Instant Spray	£7.00	£42.00
T4 RSPA25	Box of 6 x 500ml Cartridge Filter Cleaner Soak	£4.50	£27.00
T4 RSPA24	Box of 6 x 1 Litre Cartridge Filter Cleaner Soak	£6.50	£39.00
T4 RSPA32	Box of 6 x 500ml Hot Tub Flush	£10.00	£60.00
T4 RSPA33	Box of 6 x 500ml Dual-purpose Hot Tub Cleaner & Preserver	£14.00	£84.00
T4 RSPA37	Box of 6 x 500ml Hot Tub Waterline Cleaner Spray	£7.50	£45.00



### Relax® Spa Speciality

DISCOUNT CODE/ PRODUCT CODE	DESCRIPTION	SINGLE PRICE	BOX PRICE
T4 RSPA30	Box of 6 x 500ml Clarifier	£3.50	£21.00
T4 RSPA29	Box of 6 x 1 Litre Clarifier	£5.00	£30.00
T4 RSPA28	Box of 6 x 500ml No-Foam	£5.00	£30.00
T4 RSPA27	Box of 6 x 1 Litre No-Foam	£8.00	£48.00
T4 RSPA31	Box of 6 x 500ml Stain & Scale Inhibitor	£7.00	£42.00
T4 RSPA57	Box of 6 x 500ml Natural Clarifier	£5.33	£32.00



### Relax® Spa Fragrance Crystals

DISCOUNT CODE/ PRODUCT CODE	DESCRIPTION	SINGLE PRICE	BOX PRICE
T10 RSPAF1	Box of 4 x 500g Tropical Fruit Fragrance	£10.00	£40.00
T10 RSPAF2	Box of 4 x 500g Bay Rum Fragrance	£10.00	£40.00
T10 RSPAF3	Box of 4 x 500g Almond & Coconut Fragrance	£10.00	£40.00
T10 RSPAF4	Box of 4 x 500g Vanilla & Wild Berry Fragrance	£10.00	£40.00



Our Spa fragrances are fully compliant with the Cosmetic Products Regulations 1223/2009.

## Relax® Premium 9 Part Spa Starter Kit

- 500g Stabilised Chlorine Granules or Brominating Granules
- 30g Energize sachet
- 500g pH Plus
- 750g pH Minus
- 500ml No Foam
- 500ml Filter Cleaner
- Spa test strips
- Spa care booklet
- Measuring spoons



### Relax® Premium 9 Part Spa Starter Kit

DISCOUNT CODE/ PRODUCT CODE	DESCRIPTION	SINGLE PRICE	BOX PRICE
T5 RSPAKIT1	⊛ Relax Spa Starter Kit Stabilised Chlorine Granules (box of 4)	£37.00	£148.00
T5 RSPAKIT3	⊛ Relax Spa Starter Kit Brominating Granules (box of 4)	£47.50	£190.00

## Relax® Essential Spa Kit

- 500g Stabilised Chlorine Granules
- 500g pH Plus
- 750g pH Minus
- 500ml No Foam
- Spa test strips
- Spa care booklet
- Measuring spoons



### Relax® Essential Spa Kit

DISCOUNT CODE/ PRODUCT CODE	DESCRIPTION	SINGLE PRICE	BOX PRICE
T5 RSPAKIT8	⊛ Relax Essential Spa Kit (box of 4)	£29.00	£116.00



## Relax® Chlorine Granules

### Relax® Stabilised Chlorine Granules

(Sodium Dichloroisocyanurate)

DISCOUNT CODE/ PRODUCT CODE	DESCRIPTION	SINGLE PRICE	BOX PRICE
T RCH012	☼ Box of 6 X 500g	£7.00	£42.00
T RCH001	☼ Box of 6 x 1kg	£12.00	£72.00
T RCH002	☼ Box of 6 x 2kg jerrycans	£20.00	£120.00
T RCH003	☼ Box of 4 x 5kg jerrycans	£44.50	£178.00
T RCH004	☼ ♦ 10kg bucket	£90.00	£90.00
T RCH005	☼ ♦ 25kg bucket	£220.00	£220.00



### Relax® Multi-Pool Chlorine Granules

(Sodium Dichloroisocyanurate, Algicide and Clarifier)

DISCOUNT CODE/ PRODUCT CODE	DESCRIPTION	SINGLE PRICE	BOX PRICE
T RCH116	☼ Box of 4 x 5kg jerrycans	£54.00	£216.00

## Relax® Chlorine Tablets

### Relax® Wrapped Multi-Pool 200g Tablets

(Trichloroisocyanuric Acid, Algicide and Clarifier)

DISCOUNT CODE/ PRODUCT CODE	DESCRIPTION	SINGLE PRICE	BOX PRICE
T RCH015	☼ Box of 6 x 2kg buckets (large tablets)	£28.00	£168.00
T RCH016	☼ Box of 4 x 5kg buckets (large tablets)	£57.00	£228.00

### Relax® Multi-Pool 20g Tablets

(Trichloroisocyanuric Acid, Algicide and Clarifier)

DISCOUNT CODE/ PRODUCT CODE	DESCRIPTION	SINGLE PRICE	BOX PRICE
T RCH138	☼ Box of 6 x 1kg pot (small tablets)	£17.00	£102.00
T RCH139	☼ Box of 4 x 5kg buckets (small tablets)	£57.00	£228.00

### Relax® Wrapped Chlorine 200g Tablets

(Trichloroisocyanuric Acid)

DISCOUNT CODE/ PRODUCT CODE	DESCRIPTION	SINGLE PRICE	BOX PRICE
T RCH006	☼ Box of 6 x 2kg buckets (large tablets)	£23.00	£138.00
T RCH007	☼ Box of 4 x 5kg buckets (large tablets)	£54.50	£218.00
T RCH008	☼ 10kg buckets (large tablets)	£106.00	£106.00
T RCH009	☼ 20kg buckets (large tablets)	£200.00	£200.00



### Relax® Chlorine Tablets (small)

(Trichloroisocyanuric Acid)

DISCOUNT CODE/ PRODUCT CODE	DESCRIPTION	SINGLE PRICE	BOX PRICE
T RCH110	☼ Box of 6 x 1kg (small tablets)	£13.00	£78.00
T RCH010	☼ ♦ Box of 6 x 2kg buckets (small tablets)	£27.00	£162.00
T RCH011	☼ ♦ Box of 4 x 5kg buckets (small tablets)	£54.50	£218.00



## Relax® Multi-Functional Pool Buoys

### Relax® Multi-Functional Pool Buoys

DISCOUNT CODE/ PRODUCT CODE	DESCRIPTION	SINGLE PRICE	BOX PRICE
T2 RCH215	6 x 1kg Small Buoys	£12.00	£72.00
T2 RCH216	4 x 2kg Big Buoys	£26.50	£106.00

- A single Pool Buoy treats pools for up to one month
- Slow release chlorine, chlorine stabiliser, clarifier and algicide
- Simple to use
- No more daily dosing
- Ideal in conjunction with occasional use of granular chlorine
- Perfect for keeping pools in sparkling condition when on holiday



Big Buoy is designed for in-ground pools up to 110,000 litres (24,000 gallons)



Small Buoy designed for above ground pools up to 25,000 litres (5,500 gallons)

## Floating Tablet Dispensers

### Floating Tablet Dispensers

DISCOUNT CODE/ PRODUCT CODE	DESCRIPTION	PRICE EACH
K ZAP702	Pool	£7.50
K ZAP703	Spa	£4.00



Pool – ZAP702



Spa – ZAP703

# DID YOU KNOW?

Plastica are committed to the Biocidal Product Regulation and all of our raw materials are from approved sources. We are fully compliant with these regulations and will continue to be. As substances are approved and authorised we will ensure all our [brands/products/trade names] are fully registered. You may see small changes in the labels, but you can trust your supply chain is secure with Plastica.

## Relax® Calcium Hypochlorite

- Granules or 10g tablets
- Ideal for indoor pools, commercial and semi-commercial pools
- Tablets contain unique anti-scaling agent which prevents blockages

### Relax® Granular Shock Chlorine

(Calcium Hypochlorite)

DISCOUNT CODE/ PRODUCT CODE	DESCRIPTION	SINGLE PRICE	BOX PRICE
T18 RCH020	☼ Box of 6 x 1kg	£16.00	£96.00
T18 RCH021	☼♦ Box of 6 x 2kg buckets	£28.00	£168.00
T18 RCH022	☼♦ Box of 4 x 5kg jerrycans	£50.00	£200.00
T18 RCH120	☼♦ 10kg bucket	£116.00	£116.00
T18 RCH121	☼♦ 25kg bucket	£280.00	£280.00

See page 240 for 25kg drums of HY PRO-70 Calcium Hypochlorite Granules and Tablets



### Relax® Calcium Hypochlorite 10g Tablets

(Complete with anti-scaling agent)

DISCOUNT CODE/ PRODUCT CODE	DESCRIPTION	PRICE EACH
T18 RCH113	☼♦ 25kg bucket - No Longer Available	NLA

## Relax® Liquid Shock

PALLET

### Sodium Hypochlorite

PRODUCT CODE	DESCRIPTION	PRICE EACH
RCH127	▲♦☼ 10ltr Sodium Hypochlorite 14/15%	£14.90
RCH129	▲♦☼ 20ltr Sodium Hypochlorite 14/15%	£27.20
RCH128	▲♦☼ Pallet (32 x 20ltr) Sodium Hypochlorite 14/15%	£864.00



**Note:** Sodium hypochlorite must be delivered on a pallet due to shipping regulations, therefore a minimum delivery charge of half a pallet will be incurred. Sodium hypochlorite is also excluded from free delivery.

## Relax® Kiddy Pool Care Paddling Pool Treatment

- Encourages water saving
- Keeps water clean and healthy for up to 2 weeks
- Chlorine-free treatment for unfiltered pools
- Acts as an algicide and bactericide
- Liquid form in convenient 50ml sachets
- Treats up to 1000 litre paddling pools



### Relax® Kiddy Pool Care Paddling Pool Treatment Sachets

DISCOUNT CODE/ PRODUCT CODE	DESCRIPTION	PRICE EACH
T19 PCH850	Box of 20 x 50ml sachets	£70.00

## Relax® Energize Sachets

### Relax® Energize Shock Sachets

(Non-Chlorine Active Oxygen Shock)

DISCOUNT CODE/ PRODUCT CODE	DESCRIPTION	SINGLE PRICE	BOX PRICE
T19 RCH078	Box of 30 x 30g sachets	£2.00	£60.00

- Ideal for use in conjunction with chlorine or bromine
- Revitalises spa and pool water
- Use as a weekly treatment
- Shock treat water without adding excessive chlorine
- Crystal clear water within minutes of use
- Supplied in sachets for accurate dosing
- Quick dissolving
- No pre-mixing required



Plastica  
www.plasticapools.net



## Relax® Bromine Products

### Relax® Bromine Tablets

(1-Bromo-3-Chloro-5, 5-Dimethylhydantoin)

DISCOUNT CODE/ PRODUCT CODE	DESCRIPTION	SINGLE PRICE	BOX PRICE
T7 RCH013	Box of 6 x 1kg	£26.00	£156.00
T7 RCH210	Box of 4 x 5kg buckets	£105.00	£420.00

### Relax® Spa Bromine Granules

(Sodium Bromide and Sodium Dichlor blend)

DISCOUNT CODE/ PRODUCT CODE	DESCRIPTION	SINGLE PRICE	BOX PRICE
T7 RCH133	Box of 4 x 5kg jerrycans	£85.00	£340.00



## Relax® Active Oxygen System

Two-part non-chlorine swimming pool sanitiser.

### Relax® Pool Active Oxygen Tabs & Micro-cide

DISCOUNT CODE/ PRODUCT CODE	DESCRIPTION	SINGLE PRICE	BOX PRICE
T6 RCH018	Box of 4 x 5kg Pool Oxygen Tabs buckets	£135.00	£540.00
T6 RCH048	Box of 4 x 5 Litre Pool Micro-cide jerrycans	£32.50	£130.00



## Relax® Non-Chlorine Shock

### Relax® Non-Chlorine Shock Granules

(Potassium Monopersulphate)

DISCOUNT CODE/ PRODUCT CODE	DESCRIPTION	SINGLE PRICE	BOX PRICE
T7 RCH023	Box of 6 x 1kg	£20.00	£120.00
T7 RCH024	Box of 4 x 5kg jerrycans	£70.00	£280.00



ALL OUR *Relax*<sup>®</sup> PRODUCTS ARE PACKED IN OUR DEDICATED PLANT WITHIN OUR PREMISES



## Relax® Water Balance Products

### Relax® pH Minus

(Sodium Bisulphate - reduces pH)

DISCOUNT CODE/ PRODUCT CODE	DESCRIPTION	SINGLE PRICE	BOX PRICE
T2 RCH118	Box of 6 x 750g	£4.50	£27.00
T2 RCH028	Box of 6 x 1.5kg	£6.00	£36.00
T2 RCH030	Box of 2 x 7kg jerrycans	£20.00	£40.00
T2 RCH031	25kg bucket	£66.00	£66.00



### Relax® pH Plus

(Sodium Carbonate - Soda Ash - increases pH)

DISCOUNT CODE/ PRODUCT CODE	DESCRIPTION	SINGLE PRICE	BOX PRICE
T2 RCH117	Box of 6 x 500g	£4.75	£28.50
T2 RCH032	Box of 6 x 1kg	£5.50	£33.00
T2 RCH033	Box of 4 x 5kg jerrycans	£15.00	£60.00
T2 RCH034	25kg bucket	£66.00	£66.00



### Relax® Total Alkalinity Plus

(Sodium Bicarbonate - raises Total Alkalinity)

DISCOUNT CODE/ PRODUCT CODE	DESCRIPTION	SINGLE PRICE	BOX PRICE
T2 RCH134	Box of 6 x 1kg	£5.50	£33.00
T2 RCH035	Box of 4 x 5kg jerrycans	£15.50	£62.00
T2 RCH036	25kg bucket	£63.00	£63.00



### Relax® Hardness Plus

(Calcium Chloride - Increases Water Hardness)

DISCOUNT CODE/ PRODUCT CODE	DESCRIPTION	SINGLE PRICE	BOX PRICE
T2 RCH137	Box of 6 x 1kg	£8.00	£48.00
T2 RCH037	Box of 4 x 5kg jerrycans	£18.00	£72.00
T2 RCH038	25kg bucket	£65.00	£65.00



### Relax® Total Alkalinity Reducer

(10% Hydrochloric Acid)

DISCOUNT CODE/ PRODUCT CODE	DESCRIPTION	SINGLE PRICE	BOX PRICE
T2 RCH504	Box of 2 x 5 Litre	£19.00	£38.00



## Relax® Algicide Products

### Relax® Algae Eliminator

(Formulated for algae destruction - 2 litres treats 40,000 litres)

DISCOUNT CODE/ PRODUCT CODE	DESCRIPTION	SINGLE PRICE	BOX PRICE
T3 RCH097	☛ Box of 6 x 2 Litre jerrycans	£16.00	£96.00

### Relax® Algicide

(Polyquat Non-Copper Algicide)

DISCOUNT CODE/ PRODUCT CODE	DESCRIPTION	SINGLE PRICE	BOX PRICE
T3 RCH039	☛ Box of 6 x 2 Litre jerrycans	£11.00	£66.00
T3 RCH040	☛ Box of 4 x 5 Litre jerrycans	£23.00	£92.00

### Relax Summerlong®

(Longlife Copper Algicide - treats 14,500 litres, lasts 3-6 months)

DISCOUNT CODE/ PRODUCT CODE	DESCRIPTION	SINGLE PRICE	BOX PRICE
T3 RCH041	☛ Box of 6 x 1 Litre bottles	£11.00	£66.00

### Clear 'n' Clean

(1 litre treats, 14,500 litres)

DISCOUNT CODE/ PRODUCT CODE	DESCRIPTION	SINGLE PRICE	BOX PRICE
T3 PCH684	☛ Box of 6 x 1 Litre bottles	£13.38	£160.50

### Relax® Concentrated Phosphate Remover

(Lanthanum Formulation)

DISCOUNT CODE/ PRODUCT CODE	DESCRIPTION	SINGLE PRICE	BOX PRICE
T3 RCH147	☛ Box of 6 x 1 Litre bottles	£16.00	£96.00



No phosphates = No algae

## Relax® Winter Care Products

### Relax® Cleaner Winter

(Polyquat and Sequestrant - 5 litres treats 45,000 litres)

DISCOUNT CODE/ PRODUCT CODE	DESCRIPTION	SINGLE PRICE	BOX PRICE
T3 RCH044	☛ Box of 4 x 5 Litre jerrycans	£11.50	£46.00

### Relax® Cleaner Winter (Concentrate)

(Polyquat and Sequestrant - 1 litres treats 45,000 litres)

DISCOUNT CODE/ PRODUCT CODE	DESCRIPTION	SINGLE PRICE	BOX PRICE
T3 RCH045	☛ Box of 6 x 500ml bottles	£5.00	£30.00
T3 RCH046	☛ Box of 6 x 1 Litre bottles	£8.00	£48.00

### Relax Winterlong®

(Longlife Copper Algicide - 1 litre treats 14,500 litres)

DISCOUNT CODE/ PRODUCT CODE	DESCRIPTION	SINGLE PRICE	BOX PRICE
T3 RCH107	☛ Box of 6 x 1 Litre bottles	£11.00	£66.00



## Relax® Clarifiers & Flocculants

### Relax® Granular Floc

(Aluminium Sulphate)

DISCOUNT CODE/ PRODUCT CODE	DESCRIPTION	SINGLE PRICE	BOX PRICE
T4 RCH054	⊛ Box of 6 x 2kg buckets	£8.00	£48.00

### Relax® Clear Tabs

(Aluminium Sulphate)

DISCOUNT CODE/ PRODUCT CODE	DESCRIPTION	SINGLE PRICE	BOX PRICE
T4 RCH055	⊛ Box of 12 Tubes Containing 8 x 100g tablets	£10.17	£122.00

### Relax® Concentrated Clarifier

DISCOUNT CODE/ PRODUCT CODE	DESCRIPTION	SINGLE PRICE	BOX PRICE
T4 RCH058	⊛ Box of 6 x 500ml bottles	£4.50	£27.00
T4 RCH057	⊛ Box of 6 x 1 Litre bottles	£6.50	£39.00
T4 RCH157	⊛ Box of 6 x 1 Litre bottles Con. Natural Pool Clarifier	£9.67	£58.00



### Relax Gel Cubes

(Flocculent)

DISCOUNT CODE/ PRODUCT CODE	DESCRIPTION	SINGLE PRICE	BOX PRICE
T3 RCH197	⊛ Carton of 10 boxes 4 x gel cubes	£14.60	£146.00

### Jolly Relax Gel Cubes

(Flocculent)

DISCOUNT CODE/ PRODUCT CODE	DESCRIPTION	SINGLE PRICE	BOX PRICE
T3 JGC001	⊛ Carton of 10 boxes 4 x gel cubes	£17.50	£175.00



## Cleaners

### Cleaners

DISCOUNT CODE/ PRODUCT CODE	DESCRIPTION	SINGLE PRICE	BOX PRICE
T4 RCH050	⊛ Box of 6 x 1 Litre bottles Tile & Liner Cleaner	£8.00	£48.00
T4 RCH049	⊛ Box of 6 x 2 Litre bottles Tile & Liner Cleaner	£12.00	£72.00



## Relax® Filter & Cartridge Cleaner

- Suitable for both sand filters and cartridges

### Relax® Filter Cleaner

DISCOUNT CODE/ PRODUCT CODE	DESCRIPTION	SINGLE PRICE	BOX PRICE
T4 RCH053	Box of 6 x 500ml bottles	£4.50	£27.00
T4 RCH052	Box of 6 x 1 Litre bottles	£6.50	£39.00



## Pleatco Pool Filter Wash

- Suitable for cartridge filters only

### Pleatco Pool Filter Wash

DISCOUNT CODE/ PRODUCT CODE	DESCRIPTION	PRICE EACH
NETT PWASH-POOL	Pleatco Pool Filterwash Tablet Single	£5.00
NETT PWASH-POOL-PAK	Pleatco Pool Filterwash Display Box of 30	£130.00

**Note:** The above prices are nett

x1 Pleatco Pool Filterwash  
Single Tablet  
PWASH-POOL



x30 Pleatco Pool  
Filterwash Display Box  
PWASH-POOL-PAK



## Water Lily®

- Absorbs oils and creams
- Protection of the waterline
- Purification of the surface water
- Absorbing action until saturation
- Display box = 36 individual boxes containing 6 pieces each

### Water Lily®

DISCOUNT CODE/ PRODUCT CODE	DESCRIPTION	PRICE EACH
K WLL001	Water Lily Box of 6 pads	£11.06
K WLL036	Water Lily Display box of 36 boxes	£364.84

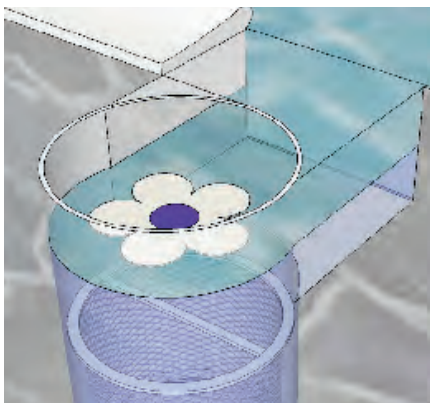

Before



After



## Pool Gom®

- Miracle waterline cleaner
- Made from patented Plastic foam
- Cleans liners, skimmers, plastic furniture, works like magic
- Display box = 36 boxes containing 3 pieces each



**Note:** Always test a small hidden area first.

### Pool Gom®

DISCOUNT CODE/ PRODUCT CODE	DESCRIPTION	PRICE EACH
K PPG036	Pool Gom Display box of 36 boxes	£298.51
K PPG001	Pool Gom Box of 3	£9.05
K PPGXL	Pool Gom XL	£25.33
K PPGXLR	Pool Gom XL refill	£10.85

The large multi-surface magic eraser connects to telescopic pole, for effective cleaning of walls, floors and waterline.



## Relax® Splasher Water Treatment Kit

- 500g Stabilised Chlorine Granules
- 750g pH Minus
- 500g pH Plus
- 500ml Algicide
- pH / Chlorine Test Strips
- Guide to Above Ground Pool Care



### Relax® Splasher Water Treatment Kit

DISCOUNT CODE/ PRODUCT CODE	DESCRIPTION	SINGLE PRICE	BOX PRICE
T5 RCH084	Box of 4 Relax Splasher Pool Water Treatment Kits	£28.50	£114.00

## Relax® Speciality Products

### Relax® Chlorine Reducer

(Sodium Thiosulphate)

DISCOUNT CODE/ PRODUCT CODE	DESCRIPTION	SINGLE PRICE	BOX PRICE
T4 RCH060	☼ Box of 6 x 1kg	£11.00	£66.00

### Relax® Multi-Stain Remover

(Formulated to **remove** metallic stains from all pool surfaces)

DISCOUNT CODE/ PRODUCT CODE	DESCRIPTION	SINGLE PRICE	BOX PRICE
T4 RCH098	☼ Box of 6 x 1kg	£28.00	£168.00

### Relax® Concentrated Stain & Scale Inhibitor

(Formulated to **prevent** metallic and calcium deposits forming on pool surfaces)

DISCOUNT CODE/ PRODUCT CODE	DESCRIPTION	SINGLE PRICE	BOX PRICE
T4 RCH062	☼ Box of 6 x 500ml bottles	£12.00	£72.00
T4 RCH061	☼ Box of 6 x 1 Litre bottles	£20.50	£123.00

### Relax® Scale & Metal Magnet

(Calcium and iron sequestrant - 1 tablets treats 10,000 gallons)

DISCOUNT CODE/ PRODUCT CODE	DESCRIPTION	SINGLE PRICE	BOX PRICE
T4 RCH076	☼ Box of 6 x 400g	£20.50	£123.00

**Note:** Scale & Metal Magnet prevents calcium precipitation and metal discolouration on pool surfaces

### Relax® Leak Sealer

(Advanced sealant for minor leaks)

DISCOUNT CODE/ PRODUCT CODE	DESCRIPTION	SINGLE PRICE	BOX PRICE
T4 RCH102	☼ Box of 6 x 1 Litre bottles	£13.50	£81.00



Plastica  
www.plasticapools.net



# We've added to our Family of Filters

**WE'VE ADDED  
EVEN MORE TO  
OUR RANGE!**

See full range  
on pages 211-212



**FEATURES**  
removable lid to take  
the Relax dosing  
POD

**Relax**  
*Spa*

Our Relax Filter Cartridge range has almost doubled for 2022, so we have more ranges available to suit your customer's hot tubs. Our filters are suitable across the whole market from inflatable hot tubs to top-end acrylic spas. We also sell above ground filter pump units, all compatible with the leading manufacturers.

The inline dosing Pod which is compatible with 20g tablets is available to be used with the most popular cartridges that feature either a removable lid or built-in shelf to locate the dosing Pod.

This Inline dosing Pod System complies with Section 76 of HSG282 regulations on sanitising hot tubs in a commercial setting – for example, holiday lettings.

Order online at [www.plasticpools.net](http://www.plasticpools.net)

## Own Brand Pool and Spa Sanitisers

### Stabilised Chlorine Granules

(Sodium Dichloroisocyanurate)

DISCOUNT CODE/ PRODUCT CODE	DESCRIPTION	SINGLE PRICE	BOX PRICE
T11 OLC001	Box of 6 x 1kg	£13.75	£82.50
T11 OLC002	Box of 6 x 2kg jerrycans	£21.75	£130.50
T11 OLC003	Box of 4 x 5kg jerrycans	£46.25	£185.00
T11 OLC004	10kg bucket	£91.75	£91.75
T11 OLC005	25kg bucket	£221.75	£221.75

### Multi-Function Tablets

(Trichloroisocyanuric Acid, Algicide & Clarifier)

DISCOUNT CODE/ PRODUCT CODE	DESCRIPTION	SINGLE PRICE	BOX PRICE
T11 OLC015	Box of 6 x 2kg large (200g) buckets	£29.75	£178.50
T11 OLC016	Box of 4 x 5kg large (200g) buckets	£58.75	£235.00
T11 OLC138	Box of 6 x 1kg Small (20g) buckets	£18.75	£112.50

### Multi-Function Chlorine Granules

(Sodium Dichloroisocyanurate, Algicide & Clarifier)

DISCOUNT CODE/ PRODUCT CODE	DESCRIPTION	SINGLE PRICE	BOX PRICE
T11 OLC116	Box of 4 x 5kg jerrycans	£55.75	£223.00

### Chlorine Tablets

(Trichloroisocyanuric Acid)

DISCOUNT CODE/ PRODUCT CODE	DESCRIPTION	SINGLE PRICE	BOX PRICE
T11 OLC006	Box of 6 x 2kg large (200g) buckets	£24.75	£148.50
T11 OLC007	Box of 4 x 5kg large (200g) buckets	£56.25	£225.00
T11 OLC008	10kg large (200g) bucket	£107.75	£107.75
T11 OLC009	20kg large (200g) bucket	£201.75	£201.75
T11 OLC110	Box of 6 x 1kg small (20g)	£14.75	£88.50
T11 OLC010	Box of 6 x 2kg small (20g) buckets	£28.75	£172.50
T11 OLC011	Box of 4 x 5kg small (20g) buckets	£56.25	£225.00

### Granular Shock Chlorine

(Calcium Hypochlorite)

DISCOUNT CODE/ PRODUCT CODE	DESCRIPTION	SINGLE PRICE	BOX PRICE
T18 OLC020	Box of 6 x 1kg	£17.75	£106.50
T18 OLC021	Box of 6 x 2kg buckets	£29.75	£178.50
T18 OLC022	Box of 4 x 5kg buckets	£51.75	£207.00
T18 OLC120	10kg bucket	£117.75	£117.75
T18 OLC121	25kg bucket	£281.75	£281.75

### Bromine Tablets

(Bromo-chloro-dimethylhydantoin)

DISCOUNT CODE/ PRODUCT CODE	DESCRIPTION	SINGLE PRICE	BOX PRICE
T7 OLC013	Box of 6 x 1kg	£27.75	£166.50
T7 OLC210	Box of 4 x 5kg buckets	£106.75	£427.00

### Bromine Granules

(Sodium Bromide and Sodium Dichlor blend)

DISCOUNT CODE/ PRODUCT CODE	DESCRIPTION	SINGLE PRICE	BOX PRICE
T7 OLC131	Box of 6 x 1kg Bromine Granules	£22.75	£136.50
T7 OLC133	Box of 4 x 5kg jerrycans Bromine Granules	£86.75	£347.00

### Non-Chlorine Shock

(Potassium Monosulphate)

DISCOUNT CODE/ PRODUCT CODE	DESCRIPTION	SINGLE PRICE	BOX PRICE
T7 OLC023	Box of 6 x 1kg	£21.75	£130.50
T7 OLC024	Box of 4 x 5kg jerrycans	£71.75	£287.00



## Own Brand Pool and Spa Water Balance, Algicides and Speciality

### pH Minus

(Sodium Bisulphate - reduces pH)

DISCOUNT CODE/ PRODUCT CODE	DESCRIPTION	SINGLE PRICE	BOX PRICE
T12 OLC028	Box of 6 x 1.5kg	£7.75	£46.50
T12 OLC030	Box of 2 x 7kg jerrycans	£21.75	£43.50
T12 OLC031	25kg bucket		

### pH Plus

(Sodium Carbonate - Soda Ash - increases pH)

DISCOUNT CODE/ PRODUCT CODE	DESCRIPTION	SINGLE PRICE	BOX PRICE
T12 OLC032	Box of 6 x 1kg	£7.25	£43.50
T12 OLC033	Box of 4 x 5kg jerrycans	£16.75	£67.00
T12 OLC034	25kg bucket	£67.75	£67.75

### Total Alkalinity Plus

(Sodium Bicarbonate - raises Total Alkalinity)

DISCOUNT CODE/ PRODUCT CODE	DESCRIPTION	SINGLE PRICE	BOX PRICE
T12 OLC134	Box of 6 x 1kg	£7.25	£43.50
T12 OLC035	Box of 4 x 5kg jerrycans	£17.25	£69.00
T12 OLC036	25kg bucket	£64.75	£64.75

### Hardness Plus

(Calcium Chloride - increases Water Hardness)

DISCOUNT CODE/ PRODUCT CODE	DESCRIPTION	SINGLE PRICE	BOX PRICE
T12 OLC137	Box of 6 x 1kg	£9.75	£58.50
T12 OLC037	Box of 4 x 5kg jerrycans	£19.75	£79.00
T12 OLC038	25kg bucket	£66.75	£66.75

### Algicides

(Polyquat Non-Copper Algicide)

DISCOUNT CODE/ PRODUCT CODE	DESCRIPTION	SINGLE PRICE	BOX PRICE
T13 OLC039	Box of 6 x 2 Litre bottles Algicide	£12.75	£76.50
T13 OLC040	Box of 4 x 5 Litre bottles Algicide	£24.75	£99.00
T13 OLC097	Box of 6 x 2 Litre bottles Algae Eliminator	£17.75	£106.50
T13 OLC041	Box of 6 x 1 Litre bottle Summerlong concentrate	£12.75	£76.50
T13 OLC044	Box of 4 x 5 Litre bottles Cleaner Winter	£13.25	£53.00
T13 OLC107	Box of 6 x 1 Litre bottle Winterlong concentrate	£12.75	£76.50

### Clarifiers

DISCOUNT CODE/ PRODUCT CODE	DESCRIPTION	SINGLE PRICE	BOX PRICE
T14 OLC054	Box of 6 x 2kg Granular Floc buckets	£9.75	£58.50
T14 OLC057	Box of 6 x 1 Litre bottles Concentrated Water Clarifier	£8.25	£49.50

### Speciality Products

DISCOUNT CODE/ PRODUCT CODE	DESCRIPTION	SINGLE PRICE	BOX PRICE
T14 OLC052	Box of 6 x 1 Litre bottles Filter & Cartridge Cleaner	£8.25	£49.50
T14 OLC053	Box of 6 x 500ml bottles Filter & Cartridge Cleaner	£6.25	£37.50
T14 OLC145	Box of 6 x 500ml bottles Spa & Hot Tub Flush	£11.75	£70.50
T14 OLC146	Box of 6 x 500ml bottles Vinyl Cover Cleaner & Preserver	£15.75	£94.50
T14 OLC064	Box of 6 x 500ml bottles Spa Clarifier	£5.25	£31.50
T14 OLC081	Box of 6 x 1 Litre bottles Spa Clarifier	£6.75	£40.50
T14 OLC065	Box of 6 x 500ml bottles Spa No-Foam	£6.75	£40.50
T14 OLC164	Box of 6 x 1 Litre bottles Spa No-Foam	£9.75	£58.50
T14 OLC062	Box of 6 x 500ml Spa Conc. Stain & Scale Inhibitor	£13.75	£82.50



**i** Own Brand Products must be ordered in a minimum of 5 boxes (mixed)

**i** Allow a minimum of 48 hours from receipt of order to despatch of Own Brand Products

# The Natural Way to Clarify your Hot Tub

Hot tub clarifiers are designed to clear up cloudy water, increase the performance of your filter, and keep the pH balance intact. They help prevent spa water from looking dull due to dead skin, algae or other dirt too small to be trapped by a filter system.



# COMMERCIAL POOL WATER TREATMENT

**PALLET**

**Note:** Multiple quantities can be added to fit onto one pallet. See page 6 for explanation.

## Calcium Hypochlorite

DISCOUNT CODE/ PRODUCT CODE	DESCRIPTION	PRICE EACH
T16 HYPRO28	25kg HY PRO-70® Granules	£280.00
T16 HYPRO25	25kg HY PRO-70® Tablets with anti-scale (10gm)	£208.00



HY PRO28  
Calcium Hypochlorite Granules



HY PRO25  
Calcium Hypochlorite Tablets

## Hydrochloric Acid & Hydrogen Peroxide

DISCOUNT CODE/ PRODUCT CODE	DESCRIPTION	PRICE EACH
T16 RCH505	25ltr Hydrochloric Acid 32%	£22.00
T16 PCHB9025	25ltr Hydrogen Peroxide 12%	£29.00

## HY PRO Water Balance

DISCOUNT CODE/ PRODUCT CODE	DESCRIPTION	PRICE EACH
T16 HYPRO31	25kg Bucket Sodium Bisulphate (pH-)	£58.00
T16 HYPRO34	25kg Bucket Sodium Carbonate (pH+)	£58.00
T16 HYPRO36	25kg Bucket Sodium Bicarbonate (TA+)	£58.00
T16 HYPRO38	25kg Bucket Calcium Chloride (Hardness +)	£58.00

Half and full pallet bulk buy prices available on all Hypro products - contact your Area Sales Rep for details.

## Bulk Bags (Minimum Order Only)

DISCOUNT CODE/ PRODUCT CODE	DESCRIPTION	PRICE EACH
T16 PCH717	25kg Bag Sodium Bisulphate Granules (pH-)	£32.00
T16 PCH716	25kg Bag Sodium Carbonate Granules (pH+)	£35.00
T16 PCH718	25kg Bag Sodium Bicarbonate Granules (TA+)	£30.00
T16 PCH715	25kg Bag Calcium Chloride Flakes (hardness+)	£30.00

## Flocculants

DISCOUNT CODE/ PRODUCT CODE	DESCRIPTION	PRICE EACH
T16 PAC123	25ltr P.A.C Poly Aluminium Chloride	£35.00
T16 PCH460	25kg Bag Aluminium Sulphate (kibbled)	£30.50
T16 PCH512	25kg Bag Aluminium Sulphate (granular)	£36.00



HY PRO Sodium Bisulphate  
(pH-)



HY PRO Sodium Carbonate  
(pH+)

**Note:** Sodium hypochlorite must be delivered on a pallet due to shipping regulations, therefore a minimum delivery charge of half a pallet will be incurred. Sodium hypochlorite is also excluded from free delivery.

## Relax® Sauna Fragrances

- Based on natural aromatherapy oils
- Helps clear stuffy heads and energises the user with refreshing essential oils

### Relax® Sauna Fragrance

DISCOUNT CODE/ PRODUCT CODE	DESCRIPTION	SINGLE PRICE	BOX PRICE
T16 RCH071	4 x 5 Litre Eucalyptus	£40.00	£160.00



# COMMERCIAL POOL WATER TESTING

## Test Kits & Accessories

### Lovibond Comparator Test Kit

DISCOUNT CODE/ PRODUCT CODE	DESCRIPTION	PRICE EACH
T17 GTK585	Chlorine/Free Cl/Total Cl/pH/Cyanuric Acid/Hardness/T.A	£430.32
T17 GTK595	Bromine/pH/Cyanuric Acid/Calcium Hardness/Total Alkalinity	£430.32

### Lovibond Comparator

DISCOUNT CODE/ PRODUCT CODE	DESCRIPTION	PRICE EACH
T17 GTK205	250 DPD No.1 Tablets	£23.34
T17 GTK210	250 DPD No.3 Tablets	£24.18
T17 GTK215	250 Phenol Red Tablets	£22.69
T17 GTK865	250 Cyanuric Acid	£48.45
T17 GTK050	Bottle of 250 Total Alkalinity Tablets (tablet count)	£16.93
T17 GTK610	Bottle of 250 Calcium Hardness Tablets (tablet count)	£20.02



GTK585

### Lovibond Test Kit Accessories

DISCOUNT CODE/ PRODUCT CODE	DESCRIPTION	PRICE EACH
T17 GTK010	Pack of 5 x 10ml Square Glass Test Tube & Cap	£37.37
T17 GTK020	Pack of 5 x 10ml Square Plastic Test Tube & Cap	£22.02

## Photometers & Test Tablets

### Lovibond Photometers

DISCOUNT CODE/ PRODUCT CODE	DESCRIPTION	PRICE EACH
T17 GTK918	PoolControl 3-in-1 Photometer Kit	£477.16
T17 GTK917	PoolControl 6-in-1 Photometer Kit	£564.16
T17 GTK916	PM600 12-in-1 Photometer	£799.74
T17 GTK913	Pool Sampler	£84.73
T17 GTK915	Sample Cells Pk5	£43.80

### Lovibond Photometer Test Tablets

PRODUCT CODE	DESCRIPTION	PRICE EACH
T17 GTK205	250 DPD No.1 Tablets	£23.34
T17 GTK210	250 DPD No.3 Tablets	£24.18
T17 GTK905	250 Phenol Red Tablets	£21.17
T17 GTK865	250 Cyanuric Acid	£48.45
T17 GTK900	250 Copper No.1 & No.2 Tablets	£131.77
T17 GTK902	250 Ozone DPD No.4	£17.83
T17 GTK903	250 Calcium Hardness Tablets	£37.91
T17 GTK904	250 Total Alkalinity Tablets	£44.78

## Lovibond TDS Meter

- Waterproof
- Simple to use
- Large display screen
- Multi-range TDS (total dissolved solids) with temperature display

### Lovibond TDS Meter

DISCOUNT CODE/ PRODUCT CODE	DESCRIPTION	PRICE EACH
T17 GTK701	SD80 TDS Meter	£159.79



**NO ENVIRONMENTAL CHARGES FOR 2022**

## Pool & Spa Salt

Salt water pools are becoming increasingly popular and with a number of benefits, it's easy to see why:

- Less handling and storing of hazardous chemicals
- Kinder and softer on the skin
- No more irritated red eyes
- No unpleasant chlorine smell
- Environmentally friendly



### Pool & Spa Salt

DISCOUNT CODE/ PRODUCT CODE	DESCRIPTION	PRICE EACH
T16 SAL725	25kg Bag of Granular Pool Salt	£23.00

## Salt Water Sacrificial Anodes

- Helps protect heaters, pool lights and rails from damage by corrosion.
- Versions available for new installations, existing installations or as a ladder attachment

### New Installations – T104D

- Designed for new installations but can easily be retro fitted
- Standard 2" pipe fitting (can be reduced to 50mm or 1.5")
- Inline zinc anode for new installations
- 4' of #8 copper bonding wire included
- See-through housing allows the anode to be easily replaced when depleted

### Ladder Anode – T104B

- Zinc sacrificial anode
- Mounts onto pool rail or ladder beneath the waterline

### Sacrificial Anode – ZSA001

- Designed for new installations but can easily be retro fitted
- Standard 2" pipe fitting c/w reducers to 1.5"
- Copper bonding wire included
- See through lid allows the anode to be replaced when depleted



New Installations – T104D



Replacement Anode – T104R



Ladder Anode – T104B

### Salt Water Sacrificial Anodes

DISCOUNT CODE/ PRODUCT CODE	DESCRIPTION	PRICE EACH
K T104D	New Pool Installations	£247.00
K T104R	Replacement Anode	£179.00
K T104B	Ladder Anode	£68.00
K ZSA001	Sacrificial Anode for new installations	£143.00



New Installations – ZSA001



## Zelia Salt Chlorinator

- Colour changing cell according to pool water salinity
- 3 sizes suitable for pools up to 25m<sup>3</sup>, 50m<sup>3</sup> and 75m<sup>3</sup>
- Simple installation, easy connection
- Packed with smart features
- Eight output modes
- Robust, self-cleaning cell
- Integral flow-switch
- Titanium plates and an inbuilt flow sensor for enhanced security

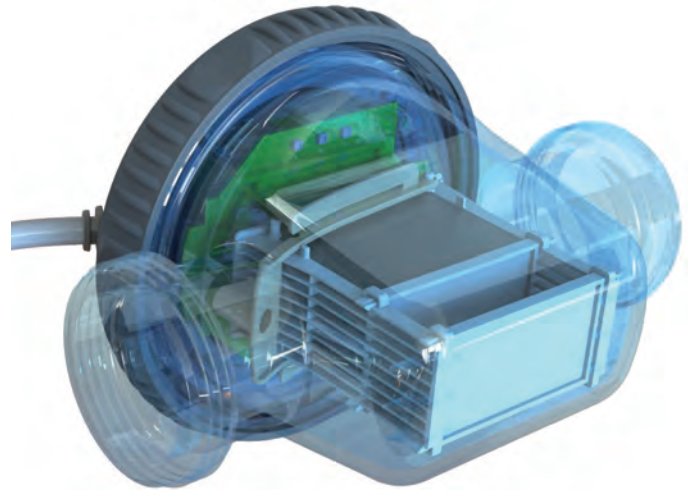

Solid titanium plates with ruthenium treatment

### Zelia Salt Chlorinator

DISCOUNT CODE/ PRODUCT CODE	DESCRIPTION	PRICE EACH
T16 ZLT025	Zelia Salt Chlorinator up to 25m <sup>3</sup>	£716.00
T16 ZLT050	Zelia Salt Chlorinator up to 50m <sup>3</sup>	£871.00
T16 ZLT075	Zelia Salt Chlorinator up to 75m <sup>3</sup>	£1,033.00

**Note:** Correct earth bonding is essential when using this product.

MODEL	ZLT025	ZLT050	ZLT075
Control panel dimensions	175 x 125 x 60 mm		
Cell length	185 mm		
Max pool volume	25 m <sup>3</sup>	50 m <sup>3</sup>	75 m <sup>3</sup>
Power supply	230V AC - 50 Hz		
Max cell flow rate & pressure	15 m <sup>3</sup> /h - 3 bar		
Salinity	2 - 4 g/l		
Chlorine production	5.5g/h	10g/h	15g/h



Illustrated colour changing light



Embedded ergonomic control



Zelia cell length: 18,5cm  
Cell ideally suited to inground filtration units



Power Supply

## Resilience E Natural Salt Chlorinator

- Simplest installation in the market
- Designed to work with variable speed pumps
- Bi-directional flow sensor
- Double “low flow” protection
- Full range input voltage 110-220 Vac
- Built in salinity and water temperature sensors
- Replaceable electrolysis cartridge

### Control Panel Display

- 24 hours super chlorination mode
- Service and maintenance built in alerts
- 4 button operation
- Cell life low LED indicator
- Clean cell identification and alert

- \* Suitable for private pools.
- \* Maximum pool size is subjected to using Cyanuric acid to balance pool water.
- \* In special pools (Overflow pools, Lap pools, Hydrotherapy pools, Public/Commercial pools) or in cases of heightened chlorine demand (such as warmer climates, high bathers load, etc.), it is recommended to choose a larger model.

### Resilience E Natural Salt Chlorinator

DISCOUNT CODE/ PRODUCT CODE	DESCRIPTION	PRICE EACH
T16 SCE018	Resilience E Maximum pool size 50-60m <sup>3</sup>	£1,282.00
T16 SCE040	Resilience E Maximum pool size 80-120m <sup>3</sup>	£1,362.00
T16 SCE060	Resilience E Maximum pool size 120-150m <sup>3</sup>	£1,426.00



Front

Cell Model	E18		E40		E60	
	Ambient Temperature		Ambient Temperature		Ambient Temperature	
Maximum pool size in cubic meters	Above 26°C 50	Less than 26°C 60	Above 26°C 80	Less than 26°C 120	Above 26°C 120	Less than 26°C 150
Chlorine Output g/h	14		26		36	

### System Overview

1. Power/Timer
2. Pump
3. Filter
4. Heater (optional)
5. Resilience E

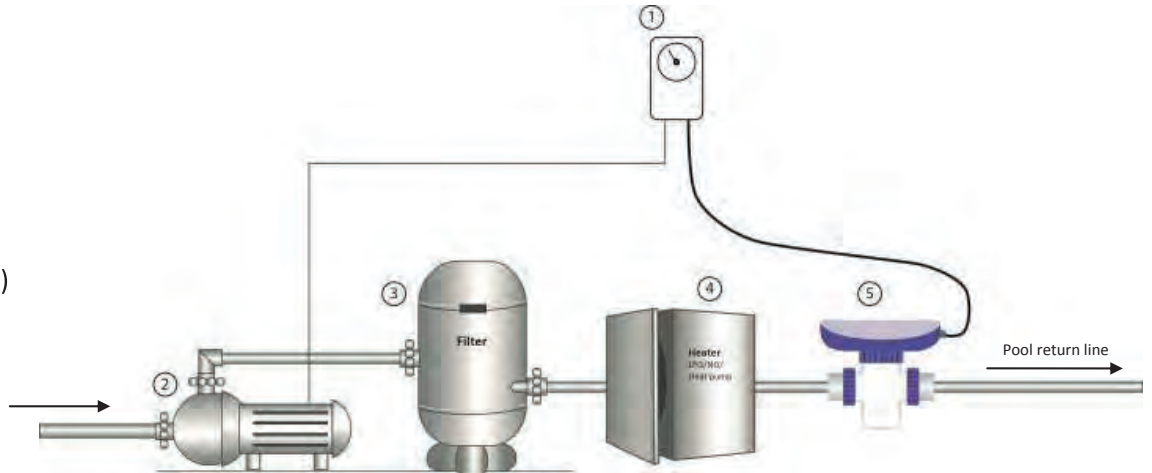

## Non-Return Valves

### Non-Return Valves

DISCOUNT CODE/ PRODUCT CODE	DESCRIPTION	PACK SIZE	PRICE EACH
K WCV001	Black 1.5" Serviceable Non-Return Valve	20	£54.00
K WCV002	Black 2" Serviceable Non-Return Valve	20	£54.00
K NRV015	1.5" White Serviceable Non-Return Valve	12	£42.00
K NRV020	2" White Serviceable Non-Return Valve	12	£45.00

### Synthetic

DISCOUNT CODE/ PRODUCT CODE	DESCRIPTION	PRICE EACH
K H-RA-172288	1.5" - 2" Corrosion Resistant	£58.00

**Note:** Image of Non-Return Valves shown on page 38 in Lighting & Pool Flow section.

# Pentair Rainbow Chlorine or Bromine Feeders



- Reduces manual handling of chemicals
- New or retro fit
- External control valve to adjust the feed rate
- No special venting required
- Holds approx 11 x 200g tablets or 98 x 20g tablets
- In-line feeder can treat pools between 20m<sup>3</sup> and 180m<sup>3</sup>
- Off-line feeder can treat pools between 25m<sup>3</sup> and 180m<sup>3</sup>

## Rainbow Chlorine or Bromine Feeders

DISCOUNT CODE/ PRODUCT CODE	DESCRIPTION	PRICE EACH
T16 H-RA-K171218	320C In-Line	£173.25
T16 H-RA-K171022	300C Off-Line	£174.30



In-Line – H-RA-K171218



Off-Line – H-RAK-K171022

Rainbow Chlorine or Bromine Feeder Data Sheet			
	Model 300 Feeder	Model 320 Feeder	
<b>Chamber Capacity</b>			
<b>Quantity for 1" Tablet</b>	98	Bottom Feed 98	Top Feed 98
<b>Weight for 1" Tablet</b>	3.5lbs	Bottom Feed 3.5lbs	Top Feed 3.5lbs
<b>Maximum Erosion in 24 hrs</b>	1.19lbs	Bottom Feed 0.67lbs	Top Feed 1.75lbs
<b>Quantity for 3" Tablet</b>	11	Bottom Feed 11	Top Feed 11
<b>Weight for 3" Tablet</b>	3.5lbs	Bottom Feed 4.8lbs	Top Feed 4.8lbs
<b>Treats Pool/Spa Size in Gallons per 24 hours*</b>			
<b>@10ppm</b>	11,900	Bottom Feed 6,700	Top Feed 17,500
<b>@5ppm</b>	23,800	Bottom Feed 13,400	Top Feed 35,000
<b>@2.5ppm</b>	47,600	Bottom Feed 26,800	Top Feed 70,000
<b>Dimensions</b>	21"H x 7"W x 12"D	17 <sup>3</sup> / <sub>4</sub> "H x 5"W x 10"D	
<b>Service Clearance for Lid Removal</b>	22 <sup>1</sup> / <sub>4</sub> "	Bottom Feed 19"	Top Feed 19"

\* Using 1" Trichlor Tabs

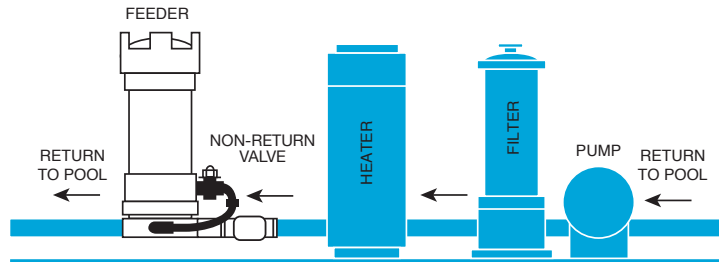

Illustration of model 320 Feeder

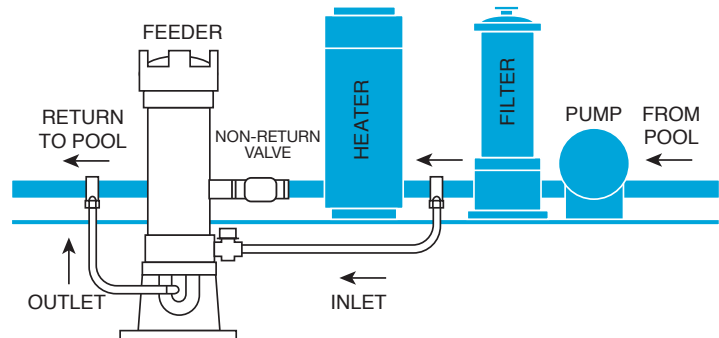

Illustration of model 300 Feeder

**Note:** We recommend non-return valves are installed - see page 248 for models available.



## Elecro High Reflection UVC Steriliser



The super reflective properties of the Elecro H.R.UV-C optimises the UV-C radiation and dramatically increases the performance.

With the H.R.UV-C, up to 95% reflectivity is achieved (if you compare this to stainless steel reactors only 20% to 28% reflection is typically achieved). The H.R.UV-C is 100% sea and saltwater compatible, unlike stainless steel units that suffer corrosion issues.

The super reflective properties of the Elecro H.R.UV-C optimises the UV-C radiation and dramatically increases the performance. The inside surface casing is extremely repellent and therefore self-cleaning. Intelligent electronics indicate when the lamps are not producing sufficient UV-C and need to be changed. Ensuring your unit is always performing optimally.

### Features and benefits

- Made in the UK
- Highest UV reflective index on the market equating to supreme efficiency
- E-PTFE reach chamber is extremely repellent, maintaining UV reflectivity
- Up to 95% reflection amplifying the exposure of microorganisms to UV
- No harmful gases or by-products produced
- Neutralises bacteria, viruses, algae and fungi that traditional chemicals cannot
- Powerful sterilisation and eliminates the smell of chlorine
- Equipped with intelligent lamp life indicator
- Average lamp life expectancy: 2 years
- Sea and salt chlorinated water compatible
- Available in three sizes: Mini (30m<sup>3</sup>), Single (55m<sup>3</sup>) and Double (110m<sup>3</sup>)
- Supplied with T-piece and flow switch
- 2 year Warranty (consumable parts excluded)



Model number HR-110-UK



Model number HR-55-UK



Model number HR-30-UK

**Note:**  
Dosing Pump models available to order on request.

### Elecro High Reflection UVC Steriliser

DISCOUNT CODE/ PRODUCT CODE	DESCRIPTION	PRICE EACH
H HR-30-UK	Mini Classic tube up to 30m <sup>3</sup> pool	£510.88
H HR-55-UK	Single Classic tube up to 55m <sup>3</sup> pool	£554.14
H HR-110-UK	Double Classic tube up to 110m <sup>3</sup> pool	£795.16

Elecro High Reflection UVC Data Sheet	
<b>Power Supply</b>	Single phase 100-240V
<b>Min. Flow Rate</b>	1.5m <sup>3</sup> /h
<b>Max. Flow Rate</b>	Mini: 12,000 litres per hour; 12m <sup>3</sup> /h Single: 16,000 litres per hour; 16m <sup>3</sup> /h Double: 32,000 litres per hour; 32m <sup>3</sup> /h
<b>Max. Pool Size</b>	Mini: 30,000 litres; 30m <sup>3</sup> Single: 55,000 litres; 55m <sup>3</sup> Double: 110,000 litres; 110m <sup>3</sup>
<b>Max. Power Consumption</b>	Mini: 40W Single: 64W Double: 128W
<b>Lamp</b>	Low pressure/high output
<b>Lamp Life</b>	9,000 hours
<b>Dosing Rate</b>	Exceeds the equivalent of 30mj/cm <sup>2</sup> at max. flow rate
<b>Ingress Protection</b>	IP64
<b>Frequency</b>	50/60 Hz
<b>Working Pressure</b>	3 Bar maximum
<b>Water Connections</b>	2"/63mm stepped ABS unions + reducers 1½/50mm
<b>Salt Water</b>	100% chlorinated salt and sea water safe
<b>Mounting</b>	Vertical or horizontal wall mounting
<b>Oxidisation Processes</b>	UV



## Electro Quantum Photocatalytic Oxidisation



Quantum uses new ceramic Nano Crystal technology, a prime focus of the science world today; possessing the power to sterilise sewage into drinking water without the use of chemicals.

### Features and benefits

- Made in the UK
- Photocatalytic TiO<sub>2</sub>/Mo oxidiser and clarifier
- Combined photocatalytic, hydroxyl radical and UV technology
- Eliminates contaminants, leaving water looking fresh and clean
- Reduces the need for chemicals in the pool
- Keeps your family safe from dangerous microorganisms such as cryptosporidium, adenoviruses and naegleria fowleri
- Optional smart peristaltic dosing system for chlorine and hydrogen peroxide (Pro model only).
- Powerful sterilisation and eliminates the smell of chlorine
- Average lamp life expectancy: 2 years
- Equipped with intelligent lamp life indicator
- Sea and salt chlorinated water compatible
- Available in three sizes: Mini (35m<sup>3</sup>), Single (65m<sup>3</sup>) and Double (130m<sup>3</sup>)
- Two year warranty (consumable parts excluded)



Model number Q-130-UK

### Electro Quantum Photocatalytic Oxidisation

DISCOUNT CODE/ PRODUCT CODE	DESCRIPTION	PRICE EACH
H Q-35-UK	Mini Tube up to 35m <sup>3</sup> pool	£859.02
H Q-65-UK	Single Tube suitable up to 65m <sup>3</sup> pool	£1,000.13
H Q-130-UK	Double Tube suitable up to 130m <sup>3</sup> pool	£1,324.58
H QP-35-UK	Mini Tube with peristaltic pump up to 35m <sup>3</sup> pool	£1,216.43
H QP-65-UK	Single Tube c/w peristaltic pump suitable for up to 65m <sup>3</sup> pool	£1,387.41
H QP-130-UK	Double Tube c/w peristaltic pump suitable for up to 130m <sup>3</sup> pool	£1,690.23

### Hydrogen Peroxide

DISCOUNT CODE/ PRODUCT CODE	DESCRIPTION	PRICE EACH
T16 PCHB9025	25 Litre Hydrogen Peroxide 12%*	£29.00

#### Electro Quantum Photocatalytic Oxidisation Data Sheet

<b>Power Supply</b>	100-240V
<b>Min. Flow Rate</b>	1.5m <sup>3</sup> /h
<b>Max. Flow Rate</b>	Mini: 10,000 litres per hour; 10m <sup>3</sup> /h Single: 14,000 litres per hour; 14m <sup>3</sup> /h Double: 28,000 litres per hour; 28m <sup>3</sup> /h
<b>Max. Pool Size</b>	Mini: 35,000 litres; 35m <sup>3</sup> Single: 65,000 litres; 65m <sup>3</sup> Double: 130,000 litres; 130m <sup>3</sup>
<b>Max. Power Consumption</b>	Mini: 40W Single: 64W Double: 128W
<b>Lamp</b>	Low pressure/high output
<b>Lamp Life</b>	9,000 hours
<b>Dosing Rate</b>	Exceeds the equivalent of 30mj/cm <sup>2</sup> at max. flow rate
<b>Ingress Protection</b>	IP64
<b>Frequency</b>	50/60 Hz
<b>Working Pressure</b>	3 Bar maximum
<b>Water Connections</b>	2"/63mm stepped ABS unions + reducers 1½/50mm
<b>Salt Water</b>	100% chlorinated salt and sea water safe
<b>Mounting</b>	Vertical or horizontal wall mounting
<b>Oxidisation Processes</b>	Quantum photocatalytic oxidiser (PCO) & hydroxyl radicals (HO)



Model number QP-65-UK



Model number QP-35-UK

## Testers & Reagents

### Rapid Dissolving Test Tablets x 100

DISCOUNT CODE/ PRODUCT CODE	DESCRIPTION	PRICE EACH
T17 RCH085	Relax DPD No 1 (free chlorine)	£8.00
T17 RCH086	Relax DPD No 3 (total chlorine)	£8.00
T17 RCH087	Relax Phenol Red (pH)	£8.00



RCH083

### Test Kits

DISCOUNT CODE/ PRODUCT CODE	DESCRIPTION	PRICE EACH
T17 RCH083	Relax Chlorine e pH test kit	£11.00
T17 GTK600	Checkit 5-in-1 cl, pH, CYA, ALK, CaH	£240.00
T17 GTK500	Chlorine & pH	£20.17
T17 GTK505	Bromine & pH	£27.11
T17 GTK510	Copper	£30.00
T17 GTK511	Copper & pH	£38.51
T17 GTK520	Total Alkalinity	£62.59
T17 GTK525	Calcium Hardness	£62.59
T17 GTK530	Cyanuric Acid	£89.83



Chlorine & PH Test Kit – GTK500

## pH Meters and Testers

### ETI pH Meters and Testers

DISCOUNT CODE/ PRODUCT CODE	DESCRIPTION	PRICE EACH
T17 PH001	pH Pal Plus Meter	£70.00
T17 BUF001	7 pH Buffer Solution Yellow 100ml	£11.20
T17 ECS001	pH Electrode Cleaning Solution 500ml	£44.80

#### pH Pal Plus Meter

- Pocket-sized pH meter, ideal for everyday use automatic calibration feature
- Easy to read 8 mm LCD display
- Display hold function
- Temperature operating range 0 to 50°C

#### pH Buffer Solution

- Use to check pH meters, testers & probes
- Supplied in 100ml bottles
- Available for 4.01, 7.00 and 10.01pH

#### pH Electrode Cleaning Solution

- Specially formulated for cleaning pH electrodes
- Simple and easy to use
- Prolongs useful life of the electrode
- Restores proper electrode performance

#### pH Pal Plus Meter

Range:	0 to 14 pH
Resolution:	0.1 pH
Accuracy:	±0.2pH
Battery:	4 x 1.5 Volt LR44 Button Cell
Battery Life:	150 Hours
Display:	8mm LCD
Dimensions:	15 x 32 x 170mm
Weight:	70 Grams
Case Material:	ABS Plastic
Guarantee:	One Year
Water/Dust Resistance:	Water Resistant
Measurement Scale:	pH



pH Pal Plus Meter  
PH001



pH Buffer Solution  
BUF001



Electrode Cleaning Solution  
ECS001

## Lovibond Comparator 5-in-1 Test Kit

- Kit tests for chlorine, pH, cyanuric acid, calcium hardness and total alkalinity
- Discs for free chlorine and pH
- 3 x Sample cells
- DPD No.1, DPD No.3, Phenol Red and Cyanuric Acid reagents
- Shaker Tube for calcium hardness and T.A.
- Calcium Hardness and Total Alkalinity Test Tablets
- Turbidity Tube for cyanuric acid test



### Lovibond Comparator 5-in-1 Test Kit

DISCOUNT CODE/ PRODUCT CODE	DESCRIPTION	PRICE EACH
T17 GTK585	Chlorine/Free Cl/Total Cl/pH/Cyanuric Acid/Hardness/T.A	£430.32
T17 GTK595	Bromine/Cyanuric Acid/pH/Calcium Hardness/ T.A	£430.32

Chlorine & PH Test Kit – GTK585

## Lovibond Scuba II Digital Pool Tester

- New generation electronic pool tester
- Large digital display
- Totally waterproof
- Simple and user friendly
- Supplied with tablet reagents, accessories and instructions

Scuba II Comes with:

- 20x DPD No1 – GTK205
- 20x Phenol Red – GTK905
- 10x DPD No.3 – GTK210
- 10x Cyanuric Acid – GTK865
- 10x Total Alkalinity – GTK904

Free Chlorine	0 – 6ppm	Total Chlorine	0 – 6ppm
Cyanuric Acid	5 – 160ppm	pH	6.8 – 8.4
Total Alkalinity	10 – 300ppm		

### Lovibond Scuba II Photometer Test Tablets

DISCOUNT CODE/ PRODUCT CODE	DESCRIPTION	PRICE EACH
T17 GTK205	250 x DPD No.1	£23.34
T17 GTK210	250 x DPD No.3	£24.18
T17 GTK905	250 x pH Phenol Red Test Tablets	£21.17
T17 GTK865	250 x Cyanuric Test Tablets	£48.45
T17 GTK904	250 x Total Alkalinity	£44.78



### Lovibond Scuba II Digital Tester

DISCOUNT CODE/ PRODUCT CODE	DESCRIPTION	PRICE EACH
T17 GTK420	Digital Tester Mk 2	£153.00



## AquaChek TruTest

- Advanced digital technology
- Dip a test strip in the water, insert in reader to get results fast
- Water resistant
- Memory stores the last 9 test results
- Powered by 2 x AA batteries (not included)
- 6 x 25 test strips

### AquaChek TruTest

DISCOUNT CODE/ PRODUCT CODE	DESCRIPTION	PRICE EACH
T17 GTK029	⊕ Digital Test Strip Reader - 25 strips	£99.00
T17 GTK027	⊕ Test Strips - 50 strips	£15.80



x50 Test Strips  
GTK027



x25 Test Strips and Reader  
GTK029

## Test Strips

### Test Strips

DISCOUNT CODE/ PRODUCT CODE	DESCRIPTION	PRICE EACH
T17 GTK122B	⊕ Box of 12 x Yellow Aquachek - Free Chlorine/pH/TA/Stabiliser - 50 strips	£154.00
T17 GTK121B	⊕ Box of 12 x Red Aquachek - Bromine/pH/TA/Total Hardness - 50 strips	£166.00
T17 RCH026	⊕ Relax 3-in-1 (single) CL, PH, TA - 50 strips	£5.90
T17 GTK345	⊕ AquaChek White Salt (single) - 10 strips	£19.70
T17 RCH093	⊕ Active Oxygen, pH & Total Alkalinity (single) - 50 strips	£21.00
T17 GTK360	⊕ Phosphate Test Strips (single) - 50 strips	£21.00
T17 GTK355	⊕ Copper Test Strips (single) - 25 strips	£21.60

#### Aquachek Yellow:

- Ideal for chlorinated pools and spas
- Tests Free Chlorine, pH, Total Alkalinity, Cyanuric Acid
- Each tube contains 50 test strips

#### Aquachek Red:

- Ideal for brominated pools and spas
- Tests Total Bromine, pH, Total Alkalinity, Total Hardness
- Each tube contains 50 test strips

#### Relax 3-in-1 Test Strips:

- CL, PH, TA
- Each tube contains 50 test strips



Aquachek Yellow, Red, Relax 3-in-1 and Salt Test Strips

Download the FREE AquaChek® Smart app and simplify pool and spa water maintenance



## FLOW, FILTER & EQUIPMENT GUIDE

Notes: Estimated requirements for outdoor pools at an ambient air temperature of 16°C and a water temperature of 27°C

Figures are based on a solar cover being used when the pool is not in use.

Figures below are for guidance only

Pool Size	18' x 9'	20' x 10'	24' x 12'	28' x 14'	30' x 15'	32' x 16'	36' x 18'	40' x 20'
Approx UK Gallons Ave Depth 4'6"	4,550	5,600	8,100	11,000	12,700	14,400	18,200	22,500
Approx UK Gallons Ave Depth 5'6"			9,900	13,500	15,500	17,600	22,300	27,500
HeatSeeker			9.5kW	12.5kW	17kW	17kW	21kW	21kW
Electric Heater	12kW	15kW	21kW	30kW	36kW	48kW	48kW	60kW
Gas BTU	125,000	125,000	125,000	175,000	175,000	175,000	250,000	250,000-400,000
Oil BTU	110,000	110,000	110,000	180,000	180,000	180,000	220,000	220,000-280,000
Heat Exchanger BTU To be matched with existing heating system	60,000/ 68,000	60,000/ 68,000	100,000/ 68,000	130,000/ 162,000	170,000/ 162,000	170,000/ 162,000	230,000	230,000
Filter	19"	19"	19"	19"	19"	24"	24"	24"
Pump HP	0.5	0.5	0.5	0.75	0.75	1	1	1
Skimmer	1	1	1	1	1	2	2	2
Inlet	2	2	2	2	2	2	2	2
Underwater Lights	1	1	1	1	1	2	2	2

All pool sizes require 1 vacuum point and 2 main drains

## TEMPERATURE CONVERSION

### FAHRENHEIT TO CELCIUS

Fahrenheit	Celcius
50.0	10.0
52.0	11.1
54.0	12.2
56.0	13.3
58.0	14.4
60.0	15.6
62.0	16.7
64.0	17.8
66.0	18.9
68.0	20.0
70.0	21.1
72.0	22.2
74.0	23.3

Fahrenheit	Celcius
76.0	24.4
78.0	25.6
80.0	26.7
82.0	27.8
84.0	28.9
86.0	30.0
88.0	31.1
90.0	32.2
92.0	33.3
94.0	34.4
96.0	35.6
98.0	36.7
100.0	37.8

### CELCIUS TO FAHRENHEIT

Celcius	Fahrenheit
10.0	50.0
11.0	51.8
12.0	53.6
13.0	55.4
14.0	57.2
15.0	59.0
16.0	60.8
17.0	62.6
18.0	64.4
19.0	66.2
20.0	68.0
21.0	69.8
22.0	71.6

Celcius	Fahrenheit
23.0	73.4
24.0	75.2
25.0	77.0
26.0	78.8
27.0	80.6
28.0	82.4
29.0	84.2
30.0	86.0
31.0	87.8
32.0	89.6
33.0	91.4
34.0	93.2
35.0	95.0

## USEFUL CONVERSIONS

Kilowatts	x 3412	= B.T.U.	Ft <sup>3</sup>	x 0.0283	= m <sup>3</sup>
Kg	x 2.205	= Pounds	Ft <sup>3</sup>	x 6.2288	= Gallons (imperial)
H.P.	x 0.7457	= Kilowatts	m <sup>3</sup>	x 220	= Gallons (imperial)
Inches	x 2.540	= Centimetres	Imp Gallons	x 4.5461	= Litres
Feet	x 0.3048	= Metres	Ft <sup>3</sup>	x 28.317	= Litres
Sq. Ft.	x 0.0929	= Sq. Metres	m <sup>3</sup>	x 1000	= Litres

## VOLUME (LIQUIDS) - IMPERIAL / US / METRIC

Imperial Gallon	= 1.201	US Gallons	1m <sup>3</sup>	= 220	Imperial Gallons
	= 0.004546	m <sup>3</sup>		= 264.20	US Gallons
	= 4.546	Litres		= 1,000	Litres
1 US Gallon	= 0.833	Imperial Gallons	1 Litre	= 0.2200	Imperial Gallons
	= 0.003785	m <sup>3</sup>		= 0.2640	US Gallons
	= 3.785	Litres		= 0.0010	m <sup>3</sup>

## PIPE DIMENSIONS & FLOW RATES

PIPE SIZE Inches	PIPE CLASS	OUTSIDE DIAMETER Inches	INTERNAL DIAMETER Inches	CROSS SECTION AREA square inches	SUCTION FLOWRATE MAX FLOW AT 1.2m/sec VELOCITY		RETURN FLOWRATE MAX FLOW AT 2.0m/sec VELOCITY	
					gal/hour	m <sup>3</sup> /hour	gal/hour	m <sup>3</sup> /hour
0.5"	E	0.842	0.692	0.376	232	1.1	386	1.8
0.75"	E	1.053	0.888	0.619	381	1.7	634	2.9
1"	E	1.321	1.102	0.954	587	2.7	978	4.4
1.25"	E	1.663	1.409	1.559	959	4.4	1598	7.3
1.5"	C	1.900	1.609	2.032	1250	5.7	2084	9.5
2"	C	2.375	2.137	3.586	2206	10.0	3677	16.7
3"	E	3.500	3.012	7.124	4382	19.9	7305	33.2
4"	E	4.500	3.846	11.615	7145	32.5	11910	54.2

## HEAD & PRESSURE

1ft Head	= 0.3048	metres head	1 metre Head	= 3281ft	head
	= 0.4335	psi		= 1.422	psi
	= 0.02989	bar		= 0.09807	bar
	= 0.8827	inch/hg vacuum	1 Litre	= 2.896	inch/hg volume
	= 0.03048	kgf/cm <sup>2</sup>		= 0.1000	kgf/cm <sup>2</sup>

## PVC PIPEWORK & FITTING COMPARISON CHART

EQUIVALENT				
METRIC			IMPERIAL	
Outside Dia.	Outside Dia. (Imperial)		Nominal Bore	Outside Dia.(Imperial)
20mm	0.67"	←-----→	3/8"	0.675"
None	-	←-----→	1/2"	0.842"
25mm	0.98"	←-----→	3/4"	1.053"
32mm	1.26"	←-----→	1"	1.321"
40mm	1.58"	←-----→	1.1/4"	1.663"
50mm	1.97"	←-----→	1.1/2"	1.900"
63mm	2.48"	←-----→	2"	2.375"
75mm	2.95"	←-----→	2.1/2"	2.960"
90mm	3.54"	←-----→	3"	3.500"
110mm	4.33"	←-----→	4"	4.500"
125mm	4.92"	←-----→	None	-
140mm	5.51"	←-----→	5"	5.520"
160mm	6.30"	←-----→	6"	6.625"
200mm	7.87"	←-----→	None	-
225mm	8.86"	←-----→	8"	8.625"

IMPORTANT NOTE: When referring to pipe sizes, metric pipe is quoted by its actual outside diameter, whereas Imperial pipe is quoted by its nominal bore or inside diameter.

## SUGGESTED PLANT FOR IN-GROUND POOLS

POOL SIZE	APPROX GALLONS	APPROX LITRES	HEAT SEEKER	ELECTRIC HEATER	GAS BTU	OIL BTU	HEAT EXCHANGER	FILTER	PUMP HR
18' x 9' 5.5m x 2.75m	4,500	20,660		12kW	125,000	110,000	60,000 - 68,000	19"	0.5
20' x 10' 6m x 3m	5,600	25,510		15kW	125,000	110,000	60,000 - 68,000	19"	0.5
24' x 12' 7m x 3.5m	8,100	36,730	12.5kW	21kW	125,000	110,000	68,000 - 100,000	19"	0.5
28' x 14' 8.5m x 4m	11,000	50,000	12.5kW	30kW	175,000	180,000	130,000 - 162,000	19"	0.75
30' x 15' 9m x 4.5m	12,700	57,400	17kW	36kW	175,000	180,000	130,000 - 162,000	19"	0.75
32' x 16' 10m x 5m	14,400	65,310	17kW	38kW	175,000	180,000	130,000 - 162,000	24"	1
36' x 18' 11m x 5.5m	18,200	82,650	21kW	48kW	250,000	220,000	230,000	24"	1
40' x 20' 12m x 6m	22,500	102,042	21kW	60kW	250,000/ 400,000	220,000/ 280,000	230,000	24"	1

Note: These volumes (gallons and litres) are based on an average depth of 4'6"/1.3m (in-ground pools only).

## SUGGESTED PLANT FOR ABOVE GROUND WOODEN POOLS

POOL TYPE	POOL SIZE	WALL HEIGHT	VOL (GALLS)	VOL (m³)	FILTRATION STANDARD	HEAT SEEKER	ELECCO
Easy Set	8' diameter	24"	425	1.94	Cartridge	AG Mini	3kW
Easy Set	12' diameter	30"	1100	5.1	Cartridge	AG Mini	3kW
Easy Set	15' diameter	33"	2100	9.7	Cartridge	AG Mini	3kW
Prism Frame	12' diameter	30"	1400	6.4	Cartridge	AG Mini	6kW
Prism Frame	15' diameter	48"	3850	17.5	Cartridge	AG Mini	9kW
Prism Frame	18' diameter	48"	3850	24	Cartridge	7.8kW	12kW
Knightsbridge Wooden Pool	4m Octagon	1.17m	2300	10.4	Sand 20" 0.75hp	7.8kW	6kW
Belgravia Wooden Pool	5.5 x 3.6m	1.31m	4600	21	Sand 20" 0.75hp	7.8kW	9kW
Bayswater Wooden Pool	6.5 x 3.6m	1.31m	5500	25	Sand 20" 0.75hp	12.5kW	12kW
Westminster Wooden Pool	8.1 x 4.6m	1.31m	8600	39.2	Sand 20" 0.75hp	12.5kW	18kW
Chelsea Wooden Pool	10 x 5m	1.31m	12600	57.4	Sand 24" 1hp	17kW	N/A
Exercise Wooden Pool	3.9 x 2.4m	1.17m	1795	8.15	Sand 20" 0.75hp	7.8kW	6kW

## HEATING GUIDELINES

### Electric heating:

- Check with your supplier that your power cable and consumer control panel is large enough to take the extra load.
- Heater should only operate when the filter pump is running. Failure to do this will result in damage being caused to the heater and pipework.

### Gas heating:

- Check your supply pipe and gas meter are large enough to accommodate the extra gas required.

### Heat Pumps:

- Sizes based on a desired temp of 29°C.
- Ambient temp should not be below 15°C.
- These figures are given on the assumption that a heat retention cover is being used on the pool.

### Heating in general:

- The heater should be switched off when backwashing the filter.
- A pressure or flow switch (standard with Elecro heaters) should be fitted to avoid the heater continuing to operate whilst backwashing.
- These recommendations should only be used as a general guide. We accept no liability for their accuracy.

# POOL SIZE CONVERSION CHART

To convert between pool size in feet to an area in square metres use the charts below

## LENGTH OF COVER IN FEET

		LENGTH OF COVER IN FEET															
		17'	18'	19'	20'	21'	22'	23'	24'	25'	26'	27'	28'	29'	30'	31'	32'
WIDTH OF COVER IN FEET	8'	13	13	14	15	16	16	17	18	19	19	20	21	22	22	23	24
	9'	14	15	16	17	18	18	19	20	21	22	23	23	24	25	26	27
	10'	16	17	18	19	20	20	21	22	23	24	25	26	27	28	29	30
	11'	17	18	19	20	21	22	24	25	26	27	28	29	30	31	32	33
	12'	19	20	21	22	23	25	26	27	28	29	30	31	32	33	35	36
	13'	21	22	23	24	25	27	28	29	30	31	33	34	35	36	37	39
	14'	22	23	25	26	27	29	30	31	33	34	35	36	38	39	40	42
	15'	24	25	26	28	29	31	32	33	35	36	38	39	40	42	43	45
	16'	25	27	28	30	31	33	34	36	37	39	40	42	43	45	46	48
	17'	27	28	30	32	33	35	36	38	39	41	43	44	46	47	49	51
	18'	28	30	32	33	35	37	38	40	42	43	45	47	48	50	52	54
	19'	30	32	34	35	37	39	41	42	44	46	48	49	51	53	55	56
	20'	32	33	35	37	39	41	43	45	46	48	50	52	54	56	58	59
	21'	33	35	37	39	41	43	45	47	49	51	53	55	57	59	60	62
	22'	35	37	39	41	43	45	47	49	51	53	55	57	59	61	63	65
	23'	36	38	41	43	45	47	49	51	53	56	58	60	62	64	66	68
24'	38	40	42	45	47	49	51	54	56	58	60	62	65	67	69	71	
25'	39	42	44	46	49	51	53	56	58	60	63	65	67	70	72	74	

## LENGTH OF COVER IN FEET

		LENGTH OF COVER IN FEET																	
		33'	34'	35'	36'	37'	38'	39'	40'	41'	42'	43'	44'	45'	46'	47'	48'	49'	50'
WIDTH OF COVER IN FEET	8'	25	25	26	27	27	28	29	30	30	31	32	33	33	34	35	36	36	37
	9'	28	28	29	30	31	32	33	33	34	35	36	37	38	38	39	40	41	42
	10'	31	32	33	33	34	35	36	37	38	39	40	41	42	43	44	45	46	46
	11'	34	35	36	37	38	39	40	41	42	43	44	45	46	47	48	49	50	51
	12'	37	38	39	40	41	42	43	45	46	47	48	49	50	51	52	54	55	56
	13'	40	41	42	43	45	46	47	48	50	51	52	53	54	56	57	58	59	60
	14'	43	44	46	47	48	49	51	52	53	55	56	57	59	60	61	62	64	65
	15'	46	47	49	50	52	53	54	56	57	59	60	61	63	64	65	67	68	70
	16'	49	51	52	54	55	56	58	59	61	62	64	65	67	68	70	71	73	74
	17'	52	54	55	57	58	60	62	63	65	66	68	69	71	73	74	76	77	79
	18'	55	57	59	60	62	64	65	67	69	70	72	74	75	77	79	80	82	84
	19'	58	60	62	64	65	67	69	71	72	74	76	78	79	81	83	85	86	88
	20'	61	63	65	67	69	71	72	74	76	78	80	82	84	85	87	89	91	93
	21'	64	66	68	70	72	74	76	78	80	82	84	86	88	90	92	94	96	98
	22'	67	69	72	74	76	78	80	82	84	86	88	90	92	94	96	98	100	102
	23'	71	73	75	77	79	81	83	85	88	90	92	94	96	98	100	103	105	107
24'	74	76	78	80	82	85	87	89	91	94	96	98	100	103	105	107	109	111	
25'	77	79	81	84	86	88	91	93	95	98	100	102	105	107	109	111	114	116	

## POLICY FOR RETURNING GOODS

### 7 Day Returns

If you do not require a product and it is within seven working days from the day after delivery, the item is unused, in its original packaging with all parts, tools and manuals and in a saleable condition you may request an RMA providing it's not one of the following:

- Made to order item
- Special order item
- Non stock item
- Water Treatment item
- Adhesives, paints or joint mix
- Above Ground Swimming Pools and associated products
- Toys, Games and Inflatables
- Any other item marked in the price list as non-returnable

You are responsible for the costs and arranging the return of the items, original delivery charges will not be refunded.

### 28 Day Returns

If you do not require a product and it is within twenty eight working days from the day after delivery, the item is unused, in its original packaging with all parts, tools and manuals and in a saleable condition you may request an RMA (returns number) providing it's not one of the following:

- Made to order item
- Special order item
- Non stock item
- Water Treatment item
- Adhesives, paints or joint mix
- Above Ground Swimming Pools and associated products
- Toys, Games and Inflatables
- Any other item marked in the price list as non-returnable

You will incur a 25% or £25 re-stocking charge per order, whichever is the greater. You are responsible for the costs and arranging the return of the items, original delivery charges will not be refunded.

Please email [returns@plasticapools.net](mailto:returns@plasticapools.net) to request your RMA (returns number)

### Returns for Exchange

An admin fee will be applied for exchanging a product. Any product exchange will be excluded from the 7 day returns policy and you be subject to a £20 charge.

For example: if you order a Winter Debris cover and want to change the fixings, you will incur this charge.

## WARRANTY CLAIMS

Plastica warranties all its products to be free from manufacturing defects for 6 months, excluding spare parts and consumables where they are warranted for 90 days only. Please refer to individual products for any extended manufacturers warranty. The warranty starts the day an item is delivered to the consumer. Where items are held in stock and therefore a delay in the supply chain between purchase from Plastica and the consumer purchase the warranty start date can be delayed by a maximum of 1 year. Proof of purchase by the consumer must be supplied, otherwise the warranty will commence the day of purchase from Plastica.

When making a warranty claim you must supply photos and where applicable a video showing the issue.

Items will be repaired where possible by supplying replacement parts, in cases where an item can't be repaired on site the item will need to be returned to Plastica. In the first 6 months of the warranty the cost of return (mainland UK addresses only) will be covered by Plastica. For items with a longer warranty; after 6 months the cost of returning the item to Plastica is the responsibility of the consumer.

Where an item cannot be repaired, or it is uneconomical to repair Plastica will supply a replacement of similar age and condition. If no suitable replacement can be supplied Plastica will refund the original purchase price if it is within the first 6 months in full (excluding spare parts and consumable items where this is limited to 90 days), after 6 months Plastica will process a partial refund based on the remaining warranty period.

The warranty is valid only if the item serial number or other product labels of identification are clearly visible and have not be removed or illegible. Warranty will also be voided where unauthorised attempts have been made to access or repair non-serviceable parts.

### Exceptions that may result in denial of a warranty claim:

1. Damage caused by careless handling, repackaging or secondary shipping not carried out by Plastica.
2. Damage due to misapplication, misuse, abuse, lack of maintenance or failure to operate equipment as specified in the owner's manual.
3. Damage caused by failure to install products as specified in the owner's manual.
4. Damage caused due to unauthorised product modifications.
5. Damage caused by negligence, or failure to properly maintain products as specified in the owner's manual.
6. Damage caused by failure to maintain water chemistry in conformity with the standards of the pool and spa industry for any length of time.
7. Damage caused by water freezing inside the product.
8. Accidental damage, fire or any other event beyond the control of Plastica.
9. Damage caused by any flooding where the item is installed.

To make a warranty claim please email: [warranty@plasticapools.net](mailto:warranty@plasticapools.net) with photos and/or videos identifying the issue along with details of purchase from Plastica and proof of sale to the consumer. Photos and videos can also be sent to our warranty claim mobile number (07520 660336), please include your customer account number and reference in the text message.

## PLASTICA TRADING TERMS

All orders processed are subject to Plastica Ltd standard Conditions of Sale. These are available on request from our Customer Services department and will appear in full at the end of our account application forms.

### Conditions of Sale Summary:

- All products and services listed are subject to standard rate of VAT
- All prices are listed in £ Sterling
- We retain the right to alter prices without notice
- Returned goods policy as defined on page 259
- Goods marked "Cannot be returned" cannot be returned
- For invoice purposes all liners and covers are costed using whole square metre prices only
- Delivery charges are applied as per page 4 and 5
- We reserve the right to change delivery charges without prior notice
- Certain items as indicated may be subject to additional carriage charges
- Pictures can only be used with the prior consent of Plastica Ltd

### Delivery

On receipt of your delivery you must inspect the packages and contents for any damages or loss, if you are unable to check your delivery you must sign for it as DAMAGED or MISSING GOODS. Failure to do so will void any later claims for damage or missing items.

All delivery services are chargeable unless specified otherwise or your order exceeds the order value threshold whereby standard delivery will be free, see pages 4 and 5 for exclusions.

All delivery services are provided in good faith and are not guaranteed, in the event of a failure in a timed service (AM, Before 10.30am or Saturday delivery). Plastica will only credit the difference between that service and our standard delivery charges.

Please ensure before planning work that the goods are confirmed as delivered, Plastica accept no liability for delays to work caused by late, damaged or missing goods.

### Transaction Limits

Every order is treated as a separate transaction, meaning that your order will be processed as soon as received by our Customer Services department. Goods cannot be added to an existing order once received.

**Plastica Ltd reserve the right to make a charge of 2% on all credit card transactions.**

### E & O E

Errors and Omissions Excepted.

## TRADEMARKS

The following names are registered trademarks of Plastica Ltd:

- Argonaut
- Endurance
- Extreme
- Heatseeker
- Hy Pro-70
- iFlo
- Piranha Clip
- Relax
- Summerlong
- SwimMaster
- Plastica and the Plastica 'P'
- Plastica Poolsaver
- Venetian
- Winterlong



**NEED SPARES?  
NO Problem**

Contact our Customer Service team for your copy of our 2022 Spares Price List (see p.8)

A5 Size



## SALES TEAM - 01424 857 802 - FAX: 01424 857814

01424 857745	Fraser McCallough 07850 988439	Water Treatment Account Manager	fraser@plasticapools.net
01424 857750	Nick Pagett 07764 247879	Technical Account Manager	nick@plasticapools.net
01424 857751	Ryan Wells 07538 587216	Technical Account Manager	ryan@plasticapools.net
01424 857720	Lizi Weeden	Sales Office Administrator	lizi@plasticapools.net

## CUSTOMER SERVICES - FOR ORDERS, QUOTES & RETURNS CALL 01424 857 802, TEXT 07860 039583 OR FAX: 01424 857 858

01424 857710	Gina Williams	Customer Services Manager	gina@plasticapools.net
01424 857704	Louisa Weddle	Customer Services Team Leader	louisa@plasticapools.net
01424 857711	Kelly French	Customer Services Advisor	kelly@plasticapools.net
01424 857701	Danielle MacNicol	Customer Services Advisor	danielle@plasticapools.net
01424 857707	Kim Shilson	Customer Services Advisor	kim@plasticapools.net
01424 857705	Sam Hudda	Customer Services Advisor	sam@plasticapools.net
01424 857703	Sarah Dawkins	Customer Services Advisor	sarah@plasticapools.net
01424 857709	Kimberly Lewis	Export Customer Advisor	kimberly@plasticapools.net

## RETURNS

01424 857780	Shrelle Gray	Returns Co-ordinator	shrelle@plasticapools.net
--------------	--------------	----------------------	---------------------------

## WEBSITE

01424 857749	Garry Holmes	ICT Assistant	garry@plasticapools.net
--------------	--------------	---------------	-------------------------

## TECHNICAL - 01424 857 818 - FAX: 01424 857 814

01424 857743	Jody Perkins	Technical Co-ordinator	jody@plasticapools.net
01424 857770	Will Dando - 07740 876746	Technical Manager	will@plasticapools.net

## WATER TREATMENT

01424 857748	Justin Jeffries 07850 506851	Water Treatment Manager	justin@plasticapools.net
01424 857770	Will Dando - 07740 876746	Technical Manager	will@plasticapools.net

## PRODUCTION - 01424 857 806 - FAX: 01424 857 807

01424 857762	Clare Crouch	Operations Manager	clare@plasticapools.net
01424 857763	Angie Simmons	Production Manager	angie@plasticapools.net
01424 857775	Tim Lawrence-King	Production Assistant	tim.lawrence-king@plasticapools.net

01424 857770	Will Dando - 07740 876746	Technical Manager	will@plasticapools.net
01424 857772	Steve Wood	Draughtsman	steven@plasticapools.net
01424 857774	Josh Keeling	Technical Assistant	josh@plasticapools.net

## EXTREME ON-SITE LINING & INSTALLATION - FAX: 01424 857 815

01424 857741	Pat Devaney - 07753 569290	Project Manager - Extreme, Service and Installation	pat@plasticapools.net
--------------	----------------------------	--	-----------------------

## FINANCE - 01424 857 812 - FAX: 01424 857 813

01424 857730	Ian A. Warne	Finance & Operations Director	ian@plasticapools.net
01424 857732	Michelle Brown	Finance Supervisor	michelle@plasticapools.net
01424 857736	Helen Turner	Finance Co-ordinator	helen@plasticapools.net

## DIRECTORS

01424 857777	Edward Campbell-Salmon	Managing Director	ed@plasticapools.net
01424 857730	Ian A. Warne	Finance & Operations Director	ian@plasticapools.net

- Above Ground Pools ..... 165-200
- Above Ground Winter Covers ..... 153-154
- ABS Pipe & Fittings ..... 34-35
- Adhesives ..... 15, 38, 55
- A.G Pumps ..... 67
- Argonaut Pumps..... 66
- Airdomes ..... 110
- Alarm ..... 112
- Algicide Products ..... 235, 242
- Aquacheck..... 254
- Automatic Cleaners..... 156-157
- Automatic Water Auto Top-up..... 30
- Azure Filter Pump Pack..... 77
  
- Backwash Hose ..... 87
- Ballvalves..... 38
- Bowman Heat Exchangers..... 88
- Bromine Tablets..... 232, 241
- Brushes ..... 161
- Bubble Covers..... 114-122,194
  
- Calcium Hypochlorite..... 230, 241, 244
- Cartridge Filter Pumps ..... 80, 81, 187
- Certikin Skimmers ..... 25
- Chlorine ..... 228, 230, 241, 244
- Clamp & Cover Plate..... 17
- Clarifiers & Flocculents..... 236, 242
- Clever Pool Pump Inverter ..... 64
- Commercial Leading Edge..... 123
- Commercial Water Treatment ..... 244-245
- CoolGuard Covers..... 120
- Copings ..... 98-101
- Corner Inserts..... 55
- Corner Steps (Easy Build in-pool)..... 53
- Counter Current Systems..... 39-44
- Covers (Heat Retention) ..... 121, 124-125
- Covers (Safety) ..... 143-144
- Covers (Solar)..... 114-120, 122, 194
- Covers (Spa)..... 127, 209
- Covers (Winter Debris) ... 145-154, 196-197
- Cover Pump ..... 154
- Cover Lifter..... 208
  
- Debris Covers..... 145-154, 196-197
- Deck Box ..... 20
- Diving Toys ..... 221
- Dosing Feeders ..... 249
- Drainage ..... 101
- Drain Pump..... 206
- Easy Drain Plus ..... 101
- Easy Set Pools ..... 185
- Electro Heat Exchanger..... 89
- Electric Heaters ..... 91-93, 190
- Endurance Filter ..... 71
- Energize Sachets..... 231
- EnergyGuard Covers ..... 115, 126
- EPS Corner Steps ..... 53
- Exercise Pool..... 177-178
- Extreme On-site Lining..... 57-62
  
- Felt..... 55
- Fence..... 111-112
- Filter & Wash ..... 80, 226, 237
- Filter Media..... 86
- Filters (Cartridge)..... 81, 86, 187, 211-212
- Filters (Sand)..... 71-79
- Fixings ..... 15, 56, 109
- Foam Underlay ..... 55
- Foot Bath..... 192
- Fountain..... 186
- Flexfit Pipe & Fittings ..... 32
- Flexible Rubber Connectors..... 33
- Floatation Aids..... 221
- Floating Dispensers..... 229
- Flow Switch ..... 31
- Fun Pools ..... 182
- Freeflo Pump ..... 69
  
- Gasket Material ..... 17
- Gauntlets ..... 17
- Gel Cubes..... 236
- Geobubble..... 115-118, 120-121, 126
- Glass Filter Media..... 86
- Granular Shock..... 230, 241, 244
  
- Handrails ..... 108
- Hand Held Vacuum Kit..... 161, 199, 200
- Heat Exchangers ..... 88-89
- Heat Pumps..... 94-95
- Heat Retention Covers..... 121, 124-127
- Heaters (Electric) ..... 91-93, 190
- Heaters (Solar)..... 96, 190-191
- Heatseeker Heat Pumps ..... 94-95
- Heating Controllers..... 89, 90
- Helios II Solar Reel ..... 134
- High Reflection UVC ..... 250
- Hose Clips..... 87
- Hydrochloric Acid..... 244
  
- iFlo Pumps ..... 68
- iFlo 500 Filter Pump Pack ..... 75, 189
- Inflatables (Novelties, Loungers) ... 215-218
- Inlets ..... 28, 31
- Intex Winter Covers..... 153, 197
- Iflo Junior 310 Filter Pump Pack..... 76, 189
- IQue Spas..... 202-203
  
- Jolly Gel..... 236
  
- Kiddy Care..... 214, 231
- Kornea..... 25
- Kreepy Krauly Sand Shark ..... 156
- Krystal Clear Filters ..... 78-79, 188-189
  
- Lacron Filters..... 72
- Corner Inserts..... 55
- Ladders ..... 102-106, 191-192
- Ladder Treads..... 107
- Leading Edge (Domestic) ..... 114
- Leaf Nets ..... 163
- Leaf Traps..... 158
- Lifesaving Equipment..... 109
- Lighting..... 20-24, 200, 210
- Linerlock..... 54
- Linerlock Fixings..... 15, 56
- Liners (Domestic)..... 46-56
- Liner Vacuum Heads ..... 163
- Liquid Chlorine ..... 230
- Loungers..... 214, 217
- Lubricants..... 16
  
- Magic Lube Lubricants..... 16
- Maintenance Kits..... 160, 199
- Main Drains ..... 28
- Marketing Material..... 18
- Metal Frame pools ..... 185
- Microfibre Broom Head..... 162

- Multicyclone Cartridges ..... 86
- Multi-Functional Pool Buoys ..... 229
- Multiport Valves ..... 82-85
  
- Nano Plug & Play Heater ..... 91, 190
- Nazca Wooden Pools ..... 168-170
- Nazca Safety Cover ..... 194
- Netskim ..... 27
- Non-chlorine Shock ..... 232, 241
- Non-Return Valves ..... 38, 253
  
- On-site Lining ..... 57-62
- Opaque Debris Cover ..... 150-151
- O-ring Repair Kit ..... 13
- Own Brand Water Treatment ..... 241
- Oxygen System ..... 232
  
- Paddling Pools ..... 214
- Paint ..... 14
- pH Adjusters ..... 234, 242
- Pillow (Inflatable Float) ..... 197
- Pipe & Fittings ..... 32-37
- Pipe & Fitting Saver ..... 13, 37
- Pipe Repair & Connectors ..... 31
- Pipemate ..... 31
- Piranha Clip ..... 128
- Plug Converter ..... 17
- Poles ..... 159
- Pond Liner ..... 53
- Pool Alarm ..... 112
- Poolsaver Safety Covers ..... 143-144
- Portapools ..... 12
- Power Pack ..... 131
- Premium Reel System ..... 133-196
- Pressure Gauges ..... 87
- Prism Framed Pools ..... 185
- Protector Sheets ..... 135-136
- Pumps ..... 14, 43, 66-69, 198, 208
- Pump Inverter ..... 64
  
- Q-Flex ..... 12
- Quantum ..... 251
- Q-Vac ..... 12
- RaeGuard Covers ..... 126
- Rainbow Feeders ..... 249
  
- Reduction Gearboxes ..... 130, 140
- Reel Protector Covers ..... 135-136
- Reels (Commercial) ..... 137-142
- Reels (Domestic) ..... 128-135, 196
- Relax Spa Filter Cartridges ..... 211-212
- Relax Winter Care ..... 239
- Repair Material ..... 15, 16, 220
- Resilience E ..... 248
- Ride-ons ..... 217-222
- Rings & Tubes ..... 219
- Robotic Cleaner ..... 157
- Rollaway Fence ..... 111-112
- Rolltrot ..... 144
- Rotabond ..... 16
  
- Sacrificial Anodes ..... 246
- Safety Covers ..... 143-144
- Safety Fence ..... 111-112
- Salt ..... 246
- Salt Chlorine Generators ..... 248
- Sand Filter Media ..... 86
- Sand Shark ..... 156
- Sauna Fragrances ..... 244
- Silicon Lubricant ..... 16
- Skimmers ..... 25-26, 187
- Skimmer Socks ..... 27
- Slidelock Reels ..... 128-132
- Sodium Hypochlorite ..... 230
- Solar Covers ..... 114-120, 122, 193
- Solar Pods ..... 96, 190-191
- Solar Reel ..... 131, 134
- Solar Shower ..... 110
- Spas ..... 202-203
- Spa Accessories ..... 204-210
- Spa Covers ..... 127, 209
- Spa Cover Safety Catch ..... 208
- Spa Steps ..... 208
- Spa Testing ..... 245, 254
- Spa Water Treatments ..... 210, 224-227, 242
- Starter Kits ..... 210, 227, 238
- Storage Covers ..... 135-136
- Submersible Pumps ..... 14, 206
- Suction Cleaners ..... 198
- Surface Cleaners ..... 236-238
- SwimMaster Counter Current ..... 44
  
- Tablet Dispensers ..... 206, 229, 249
- Tagelus Filters ..... 73
- Teflon Lubricant ..... 16
- Telescopic Poles ..... 159
- Test Strips ..... 254
- Test Kits ..... 245, 252-254
- Thermometers ..... 164
- Thermostat Controls ..... 89, 90
- Toys & Games ..... 220-221
- Triclor Tablets ..... 228, 241
- Triton Filters ..... 74
  
- Underlay ..... 55
- Underwater Lights ..... 20-24, 200, 210
- UV Sterilisers ..... 250-251
  
- Vacuum Points ..... 30
- Vacuum Heads ..... 162-163
- Vacuum Hose & Reels ..... 158
- Valves ..... 38, 248
  
- Water Tubes ..... 150
- Water Balance ..... 234, 242
- Water Auto Top-up ..... 30
- Water Lily ..... 27, 237
- Water Logs ..... 222
- Water Treatment Accs ..... 229, 245, 252-254
- Water Treatment Kits ..... 186, 245, 252-254
- Water Slide ..... 219
- Wind Resistant Wires ..... 142
- Winter Debris Covers ..... 145-154, 196-197
- Winterising Plugs ..... 13
- Winterising Treatments ..... 235, 242
- Wooden Pool Braces ..... 167
- Wooden Pool Filtration Enc. .... 167
- Wooden Pools ..... 166-184
- Wooden Pool Covers ... 122, 183, 193-194, 197
- Wooden Pools Pipework Kit ..... 167
  
- Zelia Salt Chlorinator ..... 247

**Plastica**  
**CELEBRATING**  
 1972 ~ 2022  
**50 YEARS**  
**OF TRADING**

**Plastica are due to celebrate a huge milestone this March as they go into their 50th year of trading. The privately owned business has built a reputation as one of Britain's leading independent manufacturers and distributors of swimming pool products.**



After the Oil Crisis, they produced Solar Covers & Commercial & Domestic Reel Systems.

Launched Extreme™ Pool Lining System, a re-enforced 1.5mm thick material, fitted on-site for domestic & commercial-use pools.



Due to the expansion of the business, Plastica moved to current location in St. Leonard's-on-Sea.



Increased Sales presence to cover the whole of the UK

**1972**



Boyhood friends Edward Campbell-Salmon & Peter Adlington started by making Winter Debris Covers from a small workshop in London.

**1974**

**1976**

Moved to larger premises in Hastings and started making Heat Retention Covers and Liners.



**1988**



**1996**

Introduced the 'Relax' brand of Water Treatment products, also available with 'Own Brand' labelling.

**2001**



**2005 2007/8**

Self-build Above Ground Wooden Pool kits launched, making the luxury of a pool more affordable.

Plastica consolidated the business & contracts to survive the financial crises.

**2016**

**Over 80% of Plastica's business is from their top-quality British made products. Manufacturing in-house keeps the cost lower, ensuring the customer reaps the rewards of a first-class product, that is made in Britain and complies with ISO 9001 certified standards, set by the British Assessment Bureau.**

It all began back in 1972, when boyhood friends and co-founders Edward Campbell-Salmon and Peter Adlington started manufacturing winter debris covers from a small workroom based in London. Business soon grew and they relocated to a larger premises in Hastings, East Sussex. This enabled them to add more products to their range including solar covers and reel systems.











Plastica currently manufactures from its 13,000 square metre factory. Located on a 6-acre site in St Leonard's in East Sussex, it is home to more than 78 staff that focus on manufacturing and exceptional customer service. Products are created using an impressive combination of state-of-the-art factory equipment and skilled staff crafting handmade parts. Their facility produces Wooden Pools, a range of Solar, Heat Retention and Winter Debris Covers, Reels, Pool Liners, Relax Water Treatments for pools and spas and Stainless Steel and bespoke parts, such as Ladders and Handrails and in-house ABS pipework. Some of these products are sourced from different manufacturers from around the globe and many are produced in house which is generally their preference so they can control the quality.

Like many businesses in the wet leisure industry, Plastica found demand increased during the global COVID pandemic. With the substantial increase in both inflatable and acrylic hot tubs growth has been particularly apparent in Plastica's Water Treatment department.

Last September the expansion into a nearby 5000 square foot premises provided more storage space and room for an automated filling and capping machine. This has enabled Plastica to streamline their growing orders run by an experienced team of Water Treatment staff.

Another area of increased sales continues to be Above Ground Wooden Pools, so a decision was made to extend the timber department. Manufacturing during such unprecedented times has been a challenge over the last year, but Plastica rose to the challenge. Some of their raw materials are imported and have been affected by global supply chains. Higher costs on imports have been exacerbated by the current climate. Lead times continue to be fluid to accommodate this disruption and monitored weekly by their Production team to keep customers in the loop. This is a universal issue for many UK businesses which over time will settle down. It may have slowed down production but hasn't stopped Plastica's manufacturing process and growth.

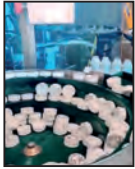
The business believes in continuous investment, and over the years has invested heavily in its manufacturing technology and IT infrastructure, to keep in-house quality control and costs down, utilising their many years of experience and maintaining their reputation as one of the UK's leading manufacturers and distributors in the swimming pool industry, and Plastica intend to continue in the same way for many years to come.

<p>Acquired Argonaut Pumps to manufacture at their premises in the UK. Also, launch Relax Spa brand of water treatment for hot tubs.</p>		<p>Plastica's Technical Manager, Will Dando made president of the BSPF (British Swimming Pool Association) for two years.</p>		<p>Thrived through lockdown – Plastica rose to the challenge of manufacturing throughout the COVID-19 pandemic.</p>	<p>NAZCA Wooden Pool range launched for a compact &amp; quick build</p> 
<p><b>2017</b></p>   <p>The Hot-Dub VW Beetle soft-top converted to a hot tub by technical wizard Jody Perkins, to showcase Plastica's various products at SPATEX including the AV Pump.</p> 	<p><b>2018</b></p> <p>Launched IQUE Hot Tubs – 7 Swedish-inspired models with globally recognised Balboa control panel and Aristech acrylic shell.</p> 	<p><b>2019</b></p> <p>Invested in a new Haitian moulding machine to increase in-house plastic production.</p> <p>New strap system launched on the Above Ground Wooden Exercise Pool.</p> 	<p><b>2020</b></p> <p>New warehouse for the expanding Water Treatment Department &amp; an automated filling and capping machine.</p> 	<p><b>2021</b></p> <p>Relax Filter Cartridge range launched for spas &amp; pools</p> 	

# SHARE YOUR PHOTOS WITH US!



**IF YOU EVER HAVE PHOTOS OF OUR PRODUCTS THAT YOU WOULD BE HAPPY TO SHARE WITH US, WE WOULD BE PLEASED TO CREDIT YOUR COMPANY ON OUR SOCIAL MEDIA AND ONLINE.**

**Plastica**  
1993

Price List **2015**

[www.plasticapools.net](http://www.plasticapools.net)

PRICE LIST 2001  
**Plastica**

[www.PLASTICAPOOLS.COM](http://www.PLASTICAPOOLS.COM)

**Plastica**

The U.K.'s leading swimming pool manufacturers and distributors

**PRICE LIST 1996**

**Plastica**  
**2020**  
PRICE LIST

MANUFACTURED in the UK

**Plastica** The Price List **2014**

[www.plasticapools.net](http://www.plasticapools.net)

**Plastica**  
PLASTICA LIMITED  
BRIDGE WAY, WYTHOUSE LANE INDUSTRIAL ESTATE,  
HASTINGS, EAST SUSSEX TN35 4NN  
TELEPHONE (0424) 436887  
FAX: 0424 434221

PRICE LIST  
EFFECTIVE: FEBRUARY 1992

**1999**  
**Plastica**

Relax it's **Plastica** Price List **2010**

[www.plasticapools.com](http://www.plasticapools.com)

**Plastica**  
**2021**  
Price List

Relax it's **Plastica**

**2003 PRICE LIST**

[www.plasticapools.com](http://www.plasticapools.com)

Relax it's **Plastica**  
[www.plasticapools.com](http://www.plasticapools.com)

Price List **2009**  
Prices in UK Pound Sterling

**PRICE LIST 2011**

[www.plasticapools.net](http://www.plasticapools.net)

**Plastica**

**Plastica**

Price List **2016**

[www.plasticapools.net](http://www.plasticapools.net)

CELEBRATING 50 YEARS OF TRADING  
1972-2022

**2022 CATALOGUE**



**2022**

~ DIGITAL ~  
**PRICE LIST**

**VERSION 2.1**

*Summer Issue*

Plastica Limited, Perimeter House, Napier Road  
St Leonards-on-Sea, East Sussex TN38 9NY UK

Tel: +44 (0) 1424 857857

Fax: +44 (0) 1424 857858

info@plasticapools.net

[www.plasticapools.net](http://www.plasticapools.net)

Find us on

